

ELECTROVERT | AquaJet



PROGRAMMING AND OPERATIONS GUIDE

Document Part # 100-00-0

Speedline Technologies

A COOKSON ELECTRONICS COMPANY



ELECTROVERT | AquaJet



PROGRAMMING AND OPERATIONS GUIDE

Manual Part #3-9317-526-00-0, Revision 2
Text Part #2-9317-526-00-0, Revision 2

Copyright© 2000 Speedline Technologies, Inc., All Rights Reserved

This document may not be reproduced, stored in a retrieval system, or transmitted in part or in whole. Photocopying, recording, or other forms of reproduction is prohibited without written permission of Electrovert®.

Published 9/15/2000

Speedline Technologies

A COOKSON ELECTRONICS COMPANY



Preface



Overview

In this section

This preface covers the following information:

Topic	See Page
To Our Customers	vi
Customer Support Structure	vii
Before You Call	x

To Our Customers

This Guide

The purpose of this guide is to help the customer obtain the greatest return on investment. Speedline suggests that operators, supervisors, and technicians responsible for operating and maintaining this equipment become familiar with the contents of these guides prior to using the equipment.

This Technical Manual includes safety information, a machine overview, an applications overview, program development instructions, standard operating instructions, advanced operating instructions, process troubleshooting, scheduled maintenance overview, and a list of error messages and audible alarms with solutions.

Other Guides in the Set

The following list of guides make up the entire information set:

Manual Name	Part Number
General Information Guide*	3-9317-525-00-0
Programming and Operations Guide	3-9317-526-00-0
Repair Guide*	3-9317-527-00-0
Preventive Maintenance Guide*	3-9317-528-00-0
Drawings*	3-9317-529-00-0
Installation Guide	3-9317-530-00-0
Options Guide*	3-9317-605-00-0
* Not released at this time.	

Customer Support Structure

Introduction

Speedline has a number of offices throughout the world ready to support your needs:

- Main Offices
- Regional Service Centers (USA)
- International Service Centers

Main Offices

Office	Location
Speedline Technologies, Inc. Electrovert Main Sales and Service Office	Technical Service Support Group P.O. Box 709, Hwy. 5 South Camdenton, MO 65020-0709 Fax: 573-346-6878 Tel: 573-346-3341 or call Toll Free @ Tel: 1-800-737-8110 e-mail: electrovert_tsc@speedline.cookson.com
Speedline Distribution Center	Parts Sales 1605 Dundee Elgin, IL 60120 Fax: 847-468-1029 Local Tel: 847-695-5750 Toll Free: 1-800-737-8110
Cookson Performance Solutions	Training Center 580-A Tollgate Rd. Elgin, IL 60123 Fax: 847-289-3797 Local Tel: 847-695-5750 Toll Free: 1-800-737-8110

Regional Service Centers (USA)

The following Service Centers are located throughout the United States:

Office	Location
North East Regional Service Center	472 Amherst St. Suite 6 Nashua, NH 03063 Fax:603-880-8757 Phone: 603-883-2488
South East Regional Service Center	1055 Windward Ridge Pkwy., Suite 140 Alpharetta, GA 30005 Fax: 770-442-1987 Phone: 770-619-5250 ext. 16
North Central Regional Service Center	580-A Tollgate Road Elgin, IL 60123 Fax: 847-289-3797 Phone: 847-695-5750
North West Regional Service Center	2968 Scott Blvd. Santa Clara, CA 95054 Fax:408-727-0672 Phone: 408-727-4650
South West Regional Service Center	1111 W. North Carrier Parkway Grand Prairie, TX 75050 Fax:972-606-1700 Phone: 972-606-1900

**International
 Service Centers**

The following centers serve the international community:

Office	Location
Speedline Technologies, LTD	Unit 1 Pincent's Kiln Industrial Park Reading Berkshire RG317SD Fax: 44 0 118 930 1401 Phone: 44 0 118 930 1400
Speedline Technologies, GmbH	Daimlerstrasse 1E 63303 Dreieich Germany Fax: 49 6103 832 299 Phone: 49 6103 832 0
Speedline Technologies, Italy	Via Liguria 2/28 I-20068 Peschiera Borromeo (MI) Italy Fax: 39-2 - 5530. 8468 Phone: 39-2-5530. 8339
Speedline Technologies, Singapore	150 Kampong Ampat KA Centre # 05-08 Singapore 368324 Fax: 65 289 9411 Phone: 65 286 6635
Speedline Technologies, Taiwan	1F, No. 11 Ching Kuo Road Taoyuan Taiwan, ROC Fax: 886 3357 6247 Phone: 886 3357 5990
Speedline Technologies, Mexico	Carretera a Base Aerea Militar KM.5 No - 5850 Edificio #11 Zapopan, Jalisco C.P. 45100 MEX Fax: 013 818 9019 Phone: 013 818 9017

Before You Call

Introduction

To help Electrovert support your machine in a timely fashion, have the following specific information available when calling in:

- System Software Version
 - Serial Tag Information
-

System Software Version

Check the software disk included in the documentation package or observe the AquaJet™ Screen when the system boots up:



Machine Serial Tag

The machine serial tag is located on side of the rear electrical panel. It provides important information that will be helpful in servicing your machine.



Table of Contents

Preface

Overview	v
To Our Customers	vi
Customer Support Structure	vii
Before You Call	x

Chapter 1. Safety Information

Overview	1
Section A. Potential Hazards	
Overview	2
Hot Surface Hazards	3
Electrical Hazards	4
Mechanical Hazards	5
Breathing Hazards	6
Weight Hazards	7
Section B. Safety Precautions	
Recommended Precautions	8
Section C. Lock-Out Tag-Out	
Overview	10
Attach Facility Lock-Out Tag-Out Device	11
Attach Machine Lock-Out Tag-Out Device	12
Perform Required Task	14
Remove Lock-Out Tag Out Devices	15

Chapter 2. AquaJet™ System

Overview	17
Section A. System Description	
Aqueous Batch Cleaning	18
Section B. System Controls	
Easy Operation	19
Section C. Chamber	
Overview	20
Chamber Description	21
Chamber Access	23
Section D. Wash/Rinse Tanks	
Wash/Dry Water Reservoirs	24
Section E. Wash/Rinse Nozzles	
Processing Cycles	26

Section F. Purge/Final Rinse Nozzles	
Final Rinse/Purge Process	27
Section G. Blower Drying	
Drying	28
Section H. Configuration Tables	
Spray and Drying Set Ups.	29
Section I. Plumbing	
Machine to Facility Connections	30
Section J. Exhaust	
Machine Venting	32
Section K. Options	
Enhancements	33
Chapter 3. Operating Controls	
Overview	35
Section A. Control Panel Layout	
Controls Description	36
Section B. Pressure Gauges	
Water Pressure	37
Section C. LCD Touch Pad Unit	
Overview	38
Touch Screen Display	39
Touch Pad Screens	40
Section D. Audible Alarms	
Alarm Speaker	41
Section E. Emergency Stop Button	
E-Stop	42
Chapter 4. Start Up and Shut Down	
Overview	43
Section A. Start Up	
Overview	44
Set Up Checklist	45
Electrical Power	46
Wash and Rinse Tank Reservoirs	47
Load Recipe	49
Verify Operation Parameters	50
Load Chamber with Product	52
Section B. System Shut Down	
Overview	54
Normal Shut Down	55
Emergency Shut Down.	56

Chapter 5. Advanced Operations

Overview	57
--------------------	----

Section A. System Configuration Screens

Overview	58
System Screens	59
Configure Alarms.	61
Configure Units	64
Configure Options	65

Section B. Maintenance Screens

Overview	67
Maintenance Screens	68
Watch Dog Test	70
Debug Process	72

Section C. Temperature Control Unit

Overview	74
West 6700 Unit	75
Configuration Mode	76
Setup Mode	78

Section D. Software Upgrade

Overview	80
Upgrade Equipment Requirements	81
I/O Controller Board Software Upgrade.	82
LCD Unit Software Upgrade	84

Chapter 6. Select and Edit Recipes

Overview	87
--------------------	----

Section A. Predefined Recipes

Overview	88
Stencil Cleaning	89
Circuit Board Cleaning	90
Mis-Print Cleaning	91
General Cleaning	92

Section B. Edit Recipes

Overview	93
Load Recipe Screen	94
System Screens	95
Edit Recipe	97

Section C. Recipes and Parameters

Overview	103
Tabular Screens	104
Graphic Screens	105

Chapter 7. Troubleshooting	
Overview	109
Section A. Operation Troubleshooting	
Problem Cause and Recovery	110
Section B. Process Troubleshooting	
Process Information	112
Chapter 8. Preventive Maintenance	
Overview	113
Section A. Safety Information	
Reference Information	114
Section B. Maintenance Screens	
Maintenance Overview	115
Section C. Maintenance Tables	
Preventive Maintenance	117
Daily Operator Maintenance	118
Daily Technician Maintenance	119
Monthly Technician Maintenance	120
Semi-Annual Technician Maintenance	121
Annual Technician Maintenance	122
Chapter 9. Error Messages	
Overview	123
Section A. Process Error Messages	
Error Message List	124
Section B. Process Alarms	
Process Alarms	126
Chapter 10. Glossary	
Overview	129
Section A. Cleaning Industry Terms	
Electronics Cleaning Terms and Definitions	130

Safety Information

Overview

Introduction

Equipment operation exposes personnel to potential health and safety hazards. Refer to the following information to ensure a safe operating environment for machines and personnel.

Safety

To ensure personal safety and avoid equipment damage, observe the following:



ATTENTION

The information provided in the safety section of this document is not intended to supersede rules and regulations governing health and safety in the local area or at the installation site. Whenever there is a conflict between the information in this section and local information, the local rules and practices govern.

In this chapter

This chapter consists of the following:

Topic	Section
Potential Hazards	A
Safety Precautions	B
Lock-Out Tag-Out	C

Section A: Potential Hazards

Overview

Introduction

This section describes various operating hazards and describes warning tags installed on the system.

In this section

Refer to the following hazard descriptions

Topic	See Page
Hot Surface Hazards	1 – 3
Electrical Hazards	1 – 4
Mechanical Hazards	1 – 5
Breathing Hazards	1 – 6
Weight Hazards	1 – 7

Hot Surface Hazards

Introduction

During normal operation this equipment and some of its components operate at temperatures up to 60–71 °C (140–160 °F). Closely follow and adhere to the warnings in this document which pertain to hot surfaces.

Safety

To ensure personal safety and avoid equipment damage, observe the following:



Hot Surface

Operating this equipment may introduce burn hazards. Avoid contact with all hot surfaces, hot water, and steam. The inside of the chamber and access door can reach temperatures in excess of 71 °C (160 °F). Take extreme caution to avoid touching the internal chamber and access door surfaces. Water temperatures reach and/or exceed 71 °C (160 °F). Steam may escape from the system cabinet when the access door is opened during operation or for maintenance, installation, upgrade, or repair procedures. Steam causes serious burns. Avoid contact with steam.



Hot Surface

Use extreme caution when working around or with hot components. Whenever possible, allow hot components to cool before handling.

Photograph

Figure 1–1 shows the hot surface warning tag.



Figure 1–1

Electrical Hazards

Introduction

Installation of this equipment involves exposure to situations which may result in electrical shock if procedures are not properly followed. Pay close attention to warnings of this nature throughout the context of this Guide.

Electrical work should only be performed by a qualified electrician.

Prior to applying power for the first time, ensure that the system is properly grounded.

Safety

To ensure personal safety and avoid equipment damage, observe the following:



Electrical Hazard

Installation of this equipment involves exposure to High Voltage. High Voltage can shock, burn, or cause death. Use extreme caution when performing voltage and amperage tests on live voltage. These procedures must be performed only by an authorized electrician, electrical engineer, or service technician familiar with testing live voltage.



Electrical Hazard

When performing tests using AMP meters, volt meters, or ohm meters, electrical shock hazard is present. These procedures must be performed only by an authorized electrician, electrical engineer, or service technician familiar with testing live voltage.

Photograph

Figure 1–2 shows the electrical hazard warning tag:



Figure 1–2

Mechanical Hazards

Introduction

Stop all moving parts when making adjustments or performing maintenance. When the system is running, avoid moving mechanisms and wear safety gear.

Safety

To ensure personal safety and avoid equipment damage, observe the following:



Entanglement Hazard

All moving parts of the AquaJet™ system, including pulleys, sprockets, chains, and the carriage assembly represent potential hazards. Use caution and avoid having hands or fingers caught in any moving mechanism. Long hair, jewelry, and other parts of loose attire could be caught in moving mechanisms and cause injury.

Photograph

Figure 1–3 shows the pinchpoint warning tag:



Figure 1–3

Breathing Hazards

Introduction

Fumes can generate from certain saponifiers, defoamers, descalers, cleaning solvents, or other chemicals used during operation. Take precautions to avoid accumulation of flammable vapors. Whenever harmful fumes are present, a proper extraction (exhaust) system must be provided. Refer to the manufacturer MSDS (Material Safety Data Sheet) for information and safety precautions concerning their products and system exhaust specifications.

Safety

To ensure personal safety and avoid equipment damage, observe the following:



Respirator

All operators should be provided with NIOSH or MSHA approved Respirators to provide effective protection from airborne residue resulting from certain saponifiers, defoamers, descalers, cleaning solvents, or other chemicals used during operation.

Weight Hazards

Introduction

Take the system weight into consideration when moving or adjusting the equipment.

Safety

To ensure personal safety and avoid equipment damage, observe the following:



CAUTION

To avoid damage to the equipment and system drain fixtures located under the machine, adjust the fork lift forks to their widest position. Use fork extensions on forks if the forks do not extend at least seven (7) feet. Be sure to place the forklifts away from any lower system plumbing.

Heavy Objects

When attempting to move heavy equipment or components, it is imperative to use the proper rigging equipment. Do not attempt to move skids or large assemblies without the use of a fork lift or other rigging equipment. Hand lifting will cause serious personal injury.

Section B: Safety Precautions

Recommended Precautions

Introduction

Refer to the following general precautions and recommendations.

Safety

To ensure personal safety, observe the following:



ATTENTION

The chemicals and cleaning agents recommended for use with AquaJet™ systems are not products of Electrovert. Please refer to the specific chemical manufacturer Material Safety Data Sheet (MSDS) for specific use, handling, and safety procedures for chemical and cleaning agent applications.

Safety Lock-Out Tag-Out Procedures

Post electrical safety tag-out and lock-out procedures in the work place and ensure that all electrical, service, and maintenance personnel are familiar with the appropriate procedures. Mark and label all power supply sources used for the equipment to ensure that the lock-out and tag-out process is easily accomplished. See Section C on page 10.

No Smoking

Post No Smoking signs in the work area and provide measures for enforcement.

Fire Extinguisher

Keep an approved fire extinguisher near the machine at all times. Familiarized all personnel with the operation and use of the fire extinguisher.

Flammables

Never store flammable material on or around the AquaJet™ machine. Exposing flammables to heating elements or hot surfaces presents a fire hazard due to the operating temperature of the machine.

Plumbing Precautions

Plumbing work should only be performed by a qualified plumber.

Sound Level

Noise levels are measured at 914.4 mm (36 in.) height and distance from the machine. Noise levels may occasionally exceed 70 dBa, however, remain consistently below 85 dBa during system operation.

Safety Perimeter

The machine is designed with a maximum length, width, and height. An access clearance of 914.4 mm (36 in.) around the machine is required to maintain and operate efficiently.

Chemical Precautions

Exercise caution when using strong cleaning agents, solvents, and other chemicals. MSDS guidelines contain specific uses and safety precautions which must be thoroughly understood and strictly followed. If in doubt about any safety notices, contact the manufacturer for clarification.

Wear appropriate clothing and safety articles when using descaler and saponifier solutions. Skin or eye irritation can occur if not handled properly.

Refer to specific chemical manufacturers MSDS guidelines for disposal and/or removal and handling of waste materials resulting from chemical operating processes.

Protective Gear

Protective clothing is required for servicing hot machine components or areas of the machine which come in contact with chemical applications. Protective clothing includes the following approval agency and items:

ANSI (American National Standard Institute) approved:

- Safety Goggles

NIOSH (National Institute for Occupational Safety and Health) OR MSHA (Mine, Safety and Health Administration) approved:

- Respirator
- Steel Toe Safety Shoes
- High Temperature, Acid, and Water Resistant Gloves
- Apron
- Long-Sleeved garment

Exhaust Ventilation

Ensure an adequate exhaust system is installed that filters and monitors the system. Clean and monitor the exhaust ventilation system on a regular basis.

Document Reference

Retain copies of this Guide for reference and new personnel training.

Good Housekeeping

Good housekeeping and a continuous cleaning schedule is important for safe and reliable system operation. Conveyor chains, sprockets, and the machine chamber require regular cleaning. Use an approved vacuum or wet cleaning method and wear suitable clothing. Never use flammable cleaning solvents. The following supplies are used for cleaning and maintenance. It is recommended these items be maintained on hand.

- Lint-Free Cloths
 - Ammonia Based Cleaner
 - Scale Stripper
 - Defoamer
-

Section C: Lock-Out Tag-Out

Overview

Introduction

Be sure to perform Lock-Out Tag-Out steps before beginning maintenance, installation, or upgrade procedures. Since lock-out tag-out procedures and policies vary from company to company, the information here is provided as a recommended guideline. Each company must establish their own specific policies and procedures.

Safety

To minimize system down time and ensure staff safety, observe the following:



ATTENTION

If procedures must continue past the shift of the person who applied the lock-out device, ensure that an employee who is working the next shift applies their lock-out device and the previous person removes the initial lock-out device.

In this Section

Refer to the following lock-out tag-out procedures:

Topic	See Page
Attach Facility Lock-Out Tag-Out Device	11
Attach Machine Lock-Out Tag-Out Device	12
Perform Required Task	14
Remove Lock-Out Tag Out Devices	15

Attach Facility Lock-Out Tag-Out Device

Introduction

Refer to the following information to isolate and identify all facility energy sources. As soon as all facility energy sources are isolated, notify affected personnel, turn facility energy source to the Off or Stop position, and attach the lock-out tag-out device. When all tasks are complete, the person who attached the lock-out tag-out device is responsible to notify affected personnel and remove the device.

Safety

To ensure personal safety and avoid equipment damage, observe the following:



Electrical Hazard

Electrical current used can kill. DO NOT TOUCH live electrical components inside the electrical enclosure. These procedures must be performed only by an authorized electrician, electrical engineer, or service technician familiar with testing live voltage.



ATTENTION

If procedures must continue past the shift of the person who applied the lock-out device, ensure that an employee who is working the next shift applies their lock-out device and the previous person removes the initial lock-out device.

Procedure

Refer to the following steps to lock-out and tag-out facility power to the AquaJet™:

1. Ensure there are no boards or other product in the system.
 2. Turn Off all AquaJet™ operating controls.
 3. Locate and identify all facility energy sources used, potential hazards, and all control devices.
 4. Notify all affected employees.
 5. Turn the facility main power input device to the Off or Stop position.
 6. Attach and secure the facility main power lock-out device in place.
 7. Test operating controls. Put all controls in the On position. Be sure no one can get hurt before testing.
 8. Return all operating controls to the Off position before proceeding.
-

Attach Machine Lock-Out Tag-Out Device

Introduction

Refer to the following information to isolate and identify all machine energy sources. As soon as all machine energy sources are isolated, notify affected personnel, turn machine energy source to the Off or Stop position, and attach the lock-out tag-out device. When all tasks are complete, the person who attached the lock-out tag-out device is responsible to notify affected personnel and remove the device.

Safety

To ensure personal safety and avoid equipment damage, observe the following:



Electrical Hazard

Electrical current used can kill. DO NOT TOUCH live electrical components inside the electrical enclosure. These procedures must be performed only by an authorized electrician, electrical engineer, or service technician familiar with testing live voltage.



ATTENTION

If procedures must continue past the shift of the person who applied the lock-out device, ensure that an employee who is working the next shift applies their lock-out device and the previous person removes the initial lock-out device.

Photograph

Figure 1–4 shows the AquaJet™ control panel:



Figure 1–4

Figure 1–5 shows the rear wash side corner of the AquaJet™ system and identifies the power switch, incoming power wires, and Serial tag locations.

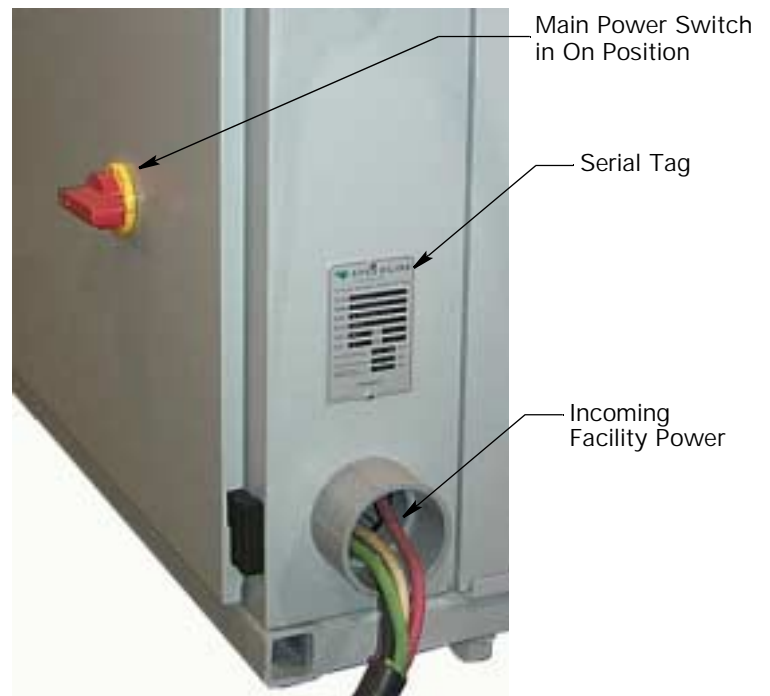

Figure 1–5

Procedure

Refer to the following steps to lock-out and tag-out AquaJet™ machine power:

1. Move to the rear of the machine and turn the main power disconnect switch to the OFF position.
2. Pull the tab and insert the lock-out device.
3. Secure the lock-out device in place.
4. Disconnect and bleed the compressed air connections.
5. The system is ready for preventive maintenance, installation, upgrade, or repair procedures.

Perform Required Task

Introduction

Proceed with the specific maintenance, installation, upgrade, or repair procedures required. Follow the directions in the Guides supplied with the system.

Safety

To ensure personal safety and avoid equipment damage, observe the following:



Electrical Hazard

Electrical current used can kill. DO NOT TOUCH live electrical components inside the electrical enclosure. These procedures must be performed only by an authorized electrician, electrical engineer, or service technician familiar with testing live voltage.



Hot Surface

Components in the system become hot during normal system operation. Heated sections of the machine produce steam. To prevent burns, allow heated sections or hot components to cool or wear required safety clothing when accessing heated areas of the machine for maintenance, installation, upgrade, or repair procedures.



ATTENTION

If procedures must continue past the shift of the person who applied the lock-out device, ensure that an employee who is working the next shift applies their lock-out device and the previous person removes the initial lock-out device.

Remove Lock-Out Tag Out Devices

Introduction

Prior to removing the Lock Out device and resuming system operation, ensure the following is complete:

- Perform and complete each scheduled maintenance, installation, upgrade, or repair task
 - Replace any worn parts, if replacement is required
 - Complete all required cleaning steps, if cleaning is required
 - Replace all enclosures removed during maintenance, installation, upgrade, or repair procedures
 - Latch or appropriately tighten down all enclosures removed during maintenance, installation, upgrade, or repair operations
-

Safety

To ensure personal safety and avoid equipment damage, observe the following:



CAUTION

If items removed during maintenance, installation, upgrade, or repair procedures are not properly replaced, damage to the equipment can occur.



ATTENTION

The person who attaches a lock-out device is responsible to remove the device.

Procedure

Use the following steps to remove AquaJet™ and facility lock-out and tag-out devices:

1. Notify all affected employees.
 2. Remove the lock-out device from the facility main power source.
 3. Turn the facility main power source to the On position.
 4. Remove the lock-out device from the rear of the machine.
 5. Place the Main Power Disconnect in the On position.
 6. Resume normal system operation. For detailed information refer to the Aqua-Jet™ Programming and Operations Guide.
-

AquaJet™ System

Overview

Introduction

This chapter describes the AquaJet system and subassemblies and how they operate.

In this chapter

This chapter consists of the following:

Topic	Section
System Description	A
System Controls	B
Chamber	C
Wash/Rinse Tanks	D
Wash/Rinse Nozzles	E
Purge/Final Rinse Nozzles	F
Blower Drying	G
Configuration Tables	H
Plumbing	I
Exhaust	J
Options	K

Section A: System Description

Aqueous Batch Cleaning

Introduction

The AquaJet™ cleaning system provides aqueous cleaning and contaminant fluid and particle removal from Printed Circuit Board (PCB) assemblies and stencils.

The futuristic designed cabinet is built of ½ in. and ¼ in. custom textured polypropolyene that resists scratching and is aesthetically pleasing. Easily removable front and side access panels are constructed of cold rolled steel. Triple welds ensure a water-tight stainless steel cleaning chamber. Triple welded polypropolyene reservoir tanks and stainless steel plumbing complete the AquaJet™ package.

Photograph

Figure 2–1 shows the AquaJet™ system



Figure 2–1

Section B: System Controls

Easy Operation

Introduction

A single LCD (Liquid Crystal Display) touch pad screen, pressure gauges, an audible alarm speaker, and Emergency Stop (E-Stop) button provide complete AquaJet™ operator control.

Using the multi-line LCD touch pad panel the operator easily manages all system functions.

Stainless steel pressure gauges provide wet section monitoring information. The gauges mount to the left of the touch pad screen for easy operator viewing and monitoring.

An audible alarms sounds on the initial occurrence of a fixed hardware alarm, configured alarm, or E-Stop occurrence until the LCD touch pad screen is touched. The alarm speaker mounts to the right of the touch pad screen.

The large red E-Stop push-pull button allows the operator to halt system operation in the event of an emergency. Pressing the switch turns Off power to the system and stops process operation. The computer, LCD touch pad screen, and 24 V power supply remain operational. The E-Stop mounts to the right of the alarm speaker.

Photograph

Figure 2–2 shows a close-up view of the AquaJet™ control panel and identifies the individual controls.



Figure 2–2

Section C: Chamber

Overview

Introduction

Cleaning takes place within the stainless steel chamber.

In this section

Refer to the following information:

Topic	See Page
Chamber Description	2 – 21
Chamber Access	2 – 23

Chamber Description

Introduction

Housed in the stainless steel cleaning chamber is a set of board mounting rails. The rails are 91.44 cm (36 in.) deep and adjust from 15.24 cm (6 in.) to 91.44 cm (36 in.) in width to accommodate a variety of boards, stencils, and processes.

Once mounted onto the rails the board remains stationary while the spray/dry carriage assembly moves from the back to the front of the machine to complete a single wash, rinse, optional final rinse/purge, or dry cycle depending on the AquaJet™ recipe loaded and the cycle processing.

Photograph

Figure 2–3 shows the internal chamber.

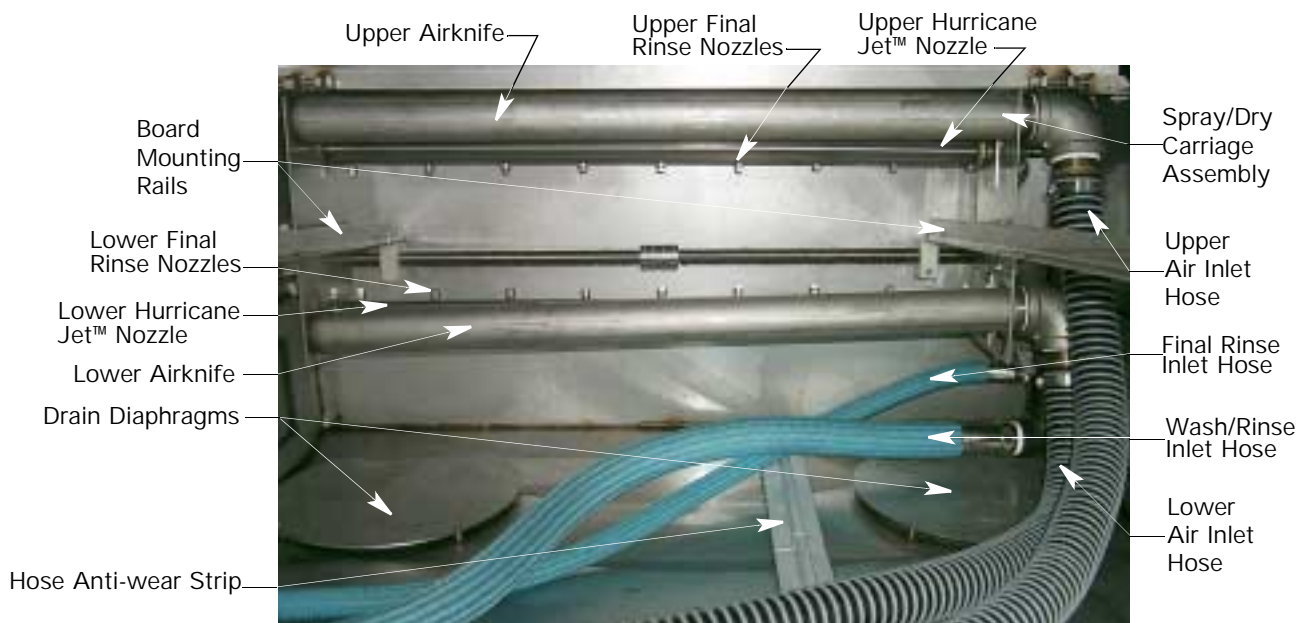

Figure 2–3

Chain Drive Conveyor

The spray/dry carriage assembly moves forward and back in the chamber. The carriage assembly mounts on a slot and the ¼ hp 90 Vdc rear-mounted motor drives the chain that moves the spray/dry carriage assembly.

A proximity switch mounted at the front right of the mounting slot senses when the carriage reaches the front, home, position. As the chain continues to run its circle, the spray/dry carriage moves back to the rear of the chamber and completes one (1) pass in the active cycle.

Photographs

Figure 2–4 shows a close up of the front mounted proximity switch and chain drive. Figure 2–5 shows the rear chain drive chain and motor.



Figure 2–4

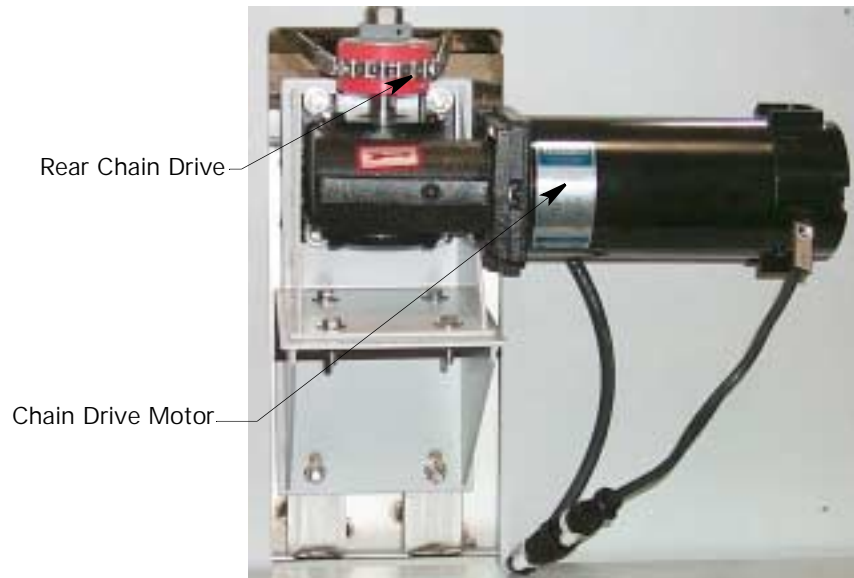

Figure 2–5

Chamber Access

Introduction

On the external sides of the chamber, access doors provide easy access to the internal lower section of the chamber and the drain diaphragm. These doors make preventive maintenance and repair procedures easier.

Safety

To ensure personal safety and avoid equipment damage, observe the following:



ATTENTION

Water may be present in the chamber. Ensure all cycles for the current recipe are complete and all water has been purged from the chamber. Have shop towels available to wipe up possible spills.

Photographs

Figure 2–7 shows the external chamber access door. Figure 2–8 shows the internal chamber and access door location.



Figure 2–7

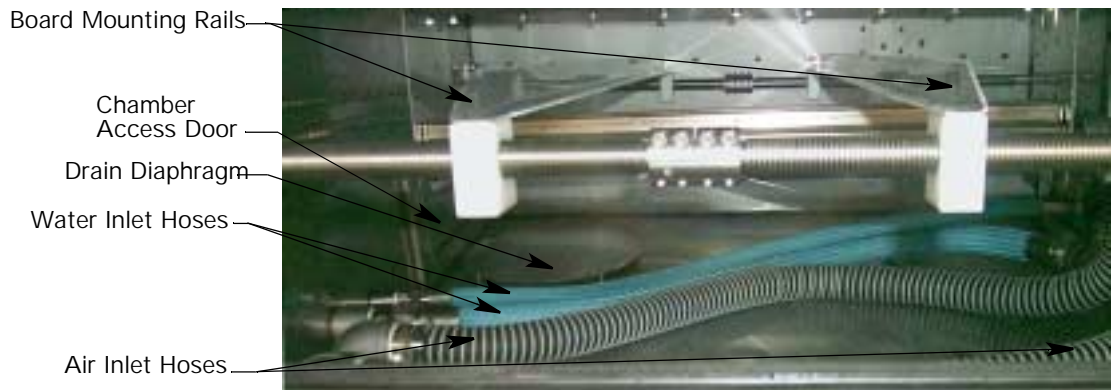

Figure 2–8

Section D: Wash/Rinse Tanks

Wash/Dry Water Reservoirs

Introduction

The AquaJet™ comes with triple welded polypropylene tanks. The wash and rinse sections each contain one (1) 151 liter (40 gal.) reservoir. Each tank contains two (2) 10 kW immersion heaters, three (3) float switches, a temperature thermocouple sensor, a temperature actuated switch, and a liquid pump inlet filter.

Heater and water temperatures display on the LCD touchpad. The internal computer continually monitors and controls tank temperature via the thermocouple sensor. If the temperature exceeds 82 °C (180 °F), the tank temperature actuated switch activates the high temperature alarm, an indicator illuminates on the LCD display, an audible alarm sounds, and the tank heaters shut off.

Photograph

Figure 2–9 shows the front inside bulkhead of a tank and identifies the controls located in the wash and rinse tanks.

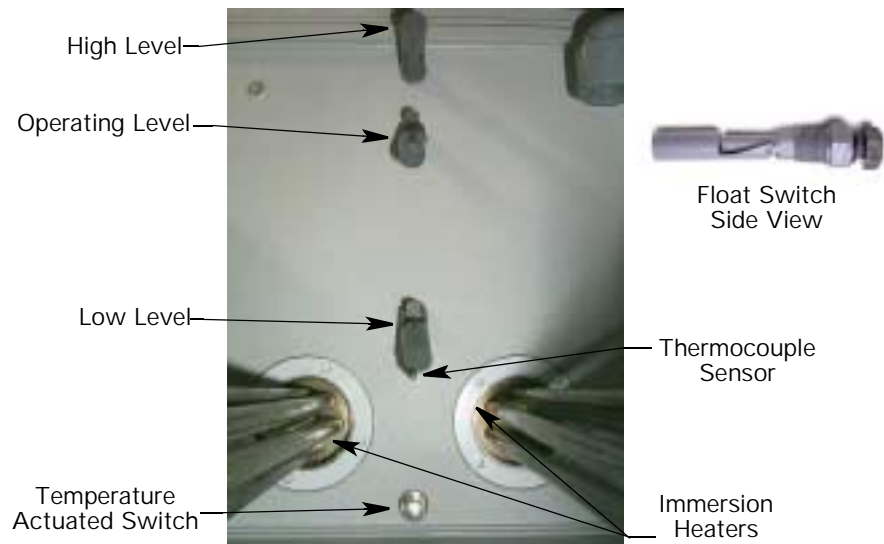

Figure 2–9

Float Switches

Liquid level float switches monitor the tank fluid level. If the tank fluid level falls below the low level float switch, the tank heaters shut off, the tank level alarm indicator illuminates, and an audible alarm sounds.

The fill solenoid, activated by the low and/or operating liquid level float switch in the tank, provides automatic tank fill capabilities. When the water pump for a tank is not running, and Tanks:On displays in the upper right corner of the touch screen, if the water level falls below normal operating level, the fill solenoid activates and fills the tank.

Photograph

Figure 2–10 shows a top view into the reservoir tank and identifies the controls.



Figure 2–10

Immersion Heaters

Two (2) immersion heaters mount at the front of the tank and stretch across the lower portion of the tank. These heaters cycle On and Off to maintain the tank liquid temperature at the setpoint reading.

Pump Filter

As the water pump pumps water into the tank the water filters through the pump recirculation filter to remove any rough contaminants present in the inlet water. These filters require periodic maintenances. Refer to the AquaJet™ Preventive Maintenance Guide for detailed instructions on removing and replacing pump filters.

Drain Screen

Mounted over the tank drain is a drain catch screen. This screen keeps any tank debris from clogging drain plumbing when the chamber effluent drains back into the tanks. During routine preventive maintenance remove the screen and clean it. For detailed maintenance information refer to the AquaJet™ Preventive Maintenance Guide.

Section E: Wash/Rinse Nozzles

Processing Cycles

Introduction

The standard recirculating wash/rinse nozzle assemblies contain one (1) upper spray manifold and one (1) lower spray manifold powered by two (2) 3 hp pumps. The upper manifold contains 27 Vee Jet™ spray nozzles spaced horizontally across and directed down toward the product rack. The lower spray manifold contains nine (9) Vee Jet™ spray nozzles spaced horizontally across and directed up toward the product rack.

Photograph

Figure 2–10 shows the upper and lower standard wash/rinse nozzles.

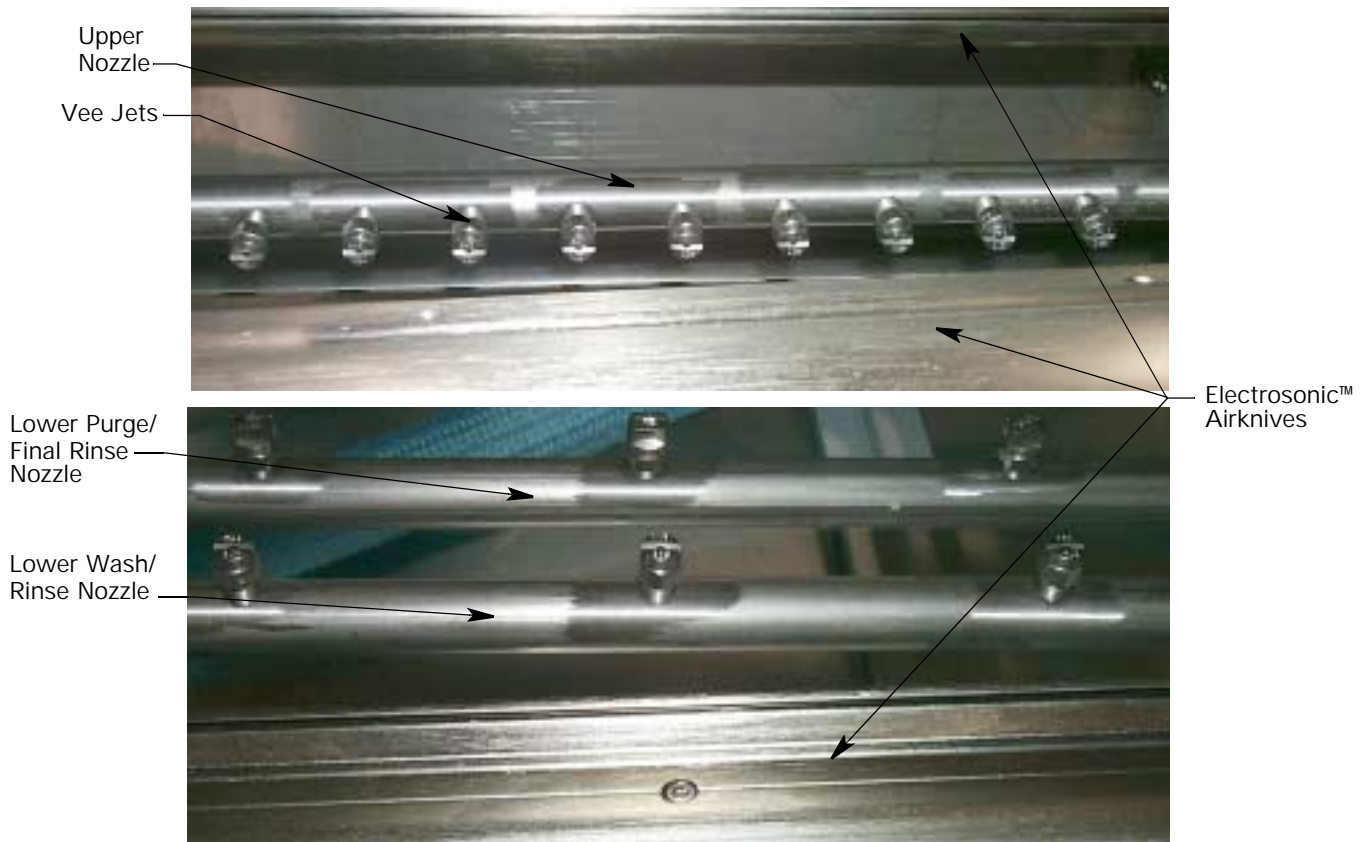

Figure 2–10

Section F: Purge/Final Rinse Nozzles

Final Rinse/Purge Process

Introduction

On hard-to-clean items or for specific types of boards an optional final rinse delivers user-supplied clean or DI water from the facility water supply. Final rinse water exits to the rinse tank to regenerate the rinse water for the next cycle.

The final rinse consists of two (2) fixed spray bars mounted on the carriage assembly behind the standard wash/rinse nozzles. Each bar contains nine (9) evenly spaced Vee Jet™ spray nozzles to distribute DI water over the mounted product during the optional final rinse cycle, or rinse water during the purge cycle.

Photographs

Figure 2–11 shows a close up view of the upper and lower standard wash/rinse nozzles, final rinse/purge nozzles, and optional Electrosonic™ airknives.



Figure 2–11

Section G: Blower Drying

Drying

Introduction

The blower cycle is configured with one (1) upper and one (1) lower, stainless steel airknife. A high velocity, high volume 7.5 hp turbine blower delivers air to the airknives. The chamber contains a thermocouple sensor to provide temperature readout via the LCD touchpad during the drying cycle.

Photograph

Figure 2–13 shows the standard airknives.

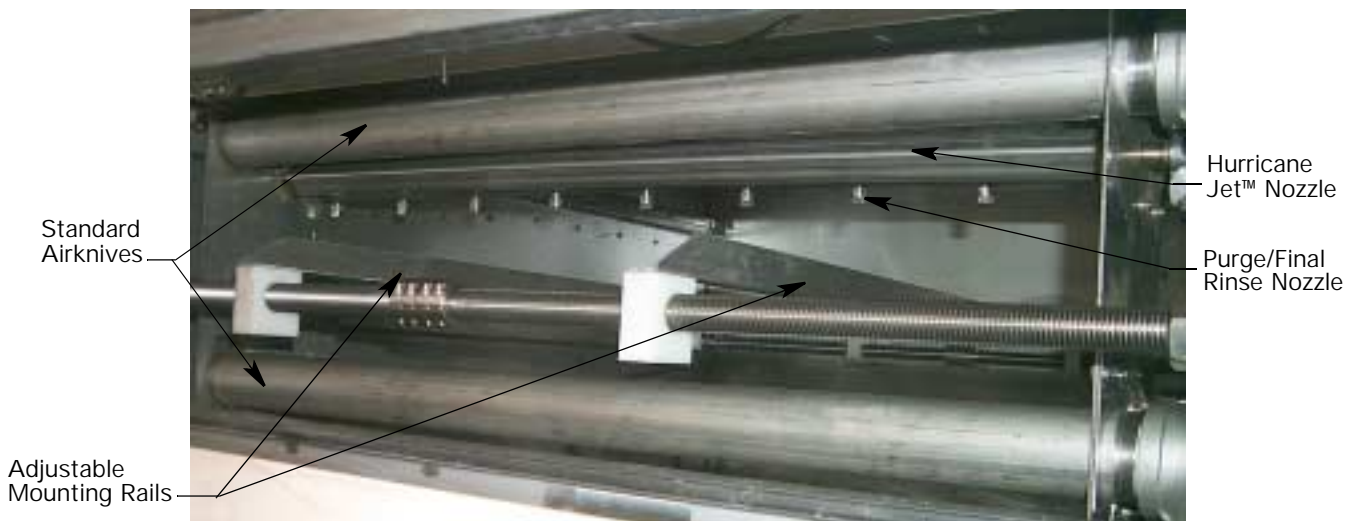

Figure 2–13

Section H: Configuration Tables

Spray and Drying Set Ups

Introduction

Stainless steel spray manifolds and airknives deliver water and air to the AquaJet™ system in the following configurations.

Standard Configuration

The following table itemizes the standard layout for the AquaJet™ system.

	Upper Manifold	Lower Manifold
Recirculating Wash/Rinse	One (1) spray bar with 27 Vee Jet Nozzles	One (1) spray bar with Nine (9) Vee Jet Nozzles
Purge/Final Rinse	One (1) with Nine (9) Vee Jet Nozzles	One (1) with Nine (9) Vee Jet Nozzles
Blower Dryer	One (1) Round Airknife	One (1) Round Airknife

Optional Configuration

The following table itemizes the optional layout for the AquaJet™ system. For detailed information on options and their operation refer to the AquaJet™ Options Guide.

	Upper Manifold	Lower Manifold
Recirculating Wash/Rinse	Two (2) offset Delta spray bars with 13 Fan Jet Nozzles each	One (1) Delta spray bar with 14 Nozzles
	One (1) Hurricane™ Jet Nozzle	One (1) Hurricane™ Jet Nozzle
Blower Dryer	One (1) Electrosonic™ Airknife	One (1) Electrosonic™ Airknife

Section I: Plumbing

Machine to Facility Connections

Introduction

The chamber uses polypropylene braided outer and Teflon™ inner flex hose in 1½ in. diameter for wash/rinse water fill, and ¾ in. diameter for final rinse fill. Corrugated thermoplastic flex hose in 2 in. diameter provides air intake. The separate final rinse line allows the use of DI water to enhance cleaning capabilities.

The fill and final rinse inlet plumbing is comprised of ¾ in. and 1½ in. orbitally welded, tubular stainless steel pipe with quick-release clamps. The welded stainless steel provides smooth transition, minimizes pressure drops, and eliminates leaks.

Upper and lower spray manifold plumbing is stainless steel, reducing corrosion and maintenance requirements.

Quick-release clamps and Teflon™ O-rings ensure quick and easy plumbing line access and field upgrades.

All drain lines are 1½ in. CPVC with ball drain valves. Brass or stainless steel solenoid drain valves are optional.

Photographs

Figure 2–14 shows the lower section of the AquaJet™ with the covers removed allowing easy access to plumbing lines, wash and rinse tanks, pumps, and the blower motor.

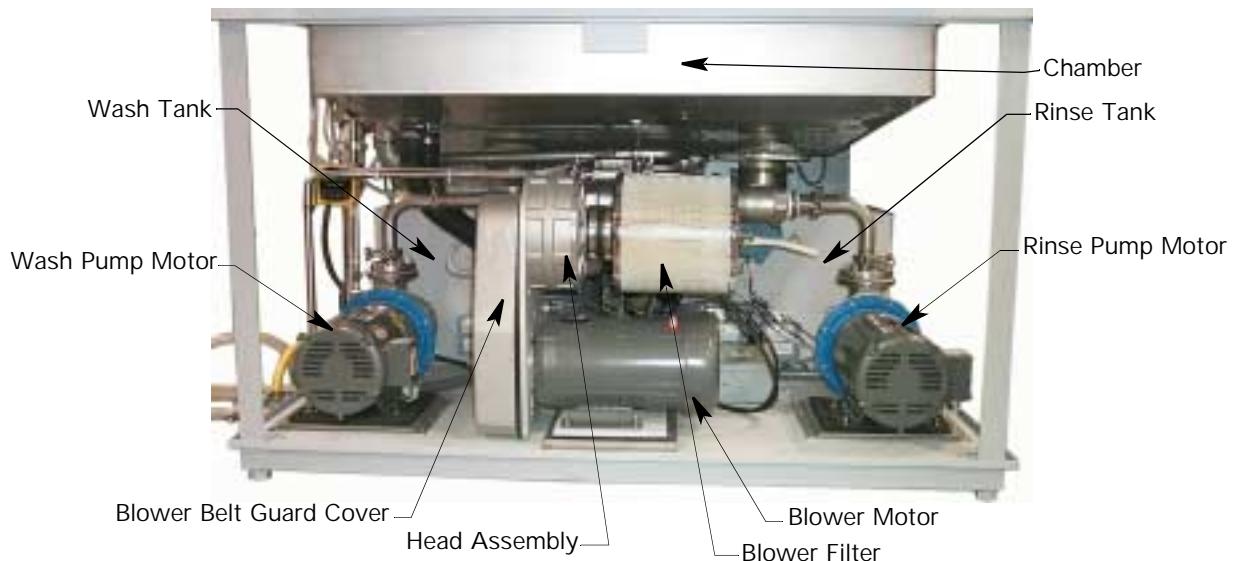

Figure 2–14

Figure 2–16 shows a close up of the plumbing and compressed air fittings on the lower wash side of the AquaJet™. Figure 2–15 shows the process of loosening and removing a quick release clamp on a stainless steel plumbing line.

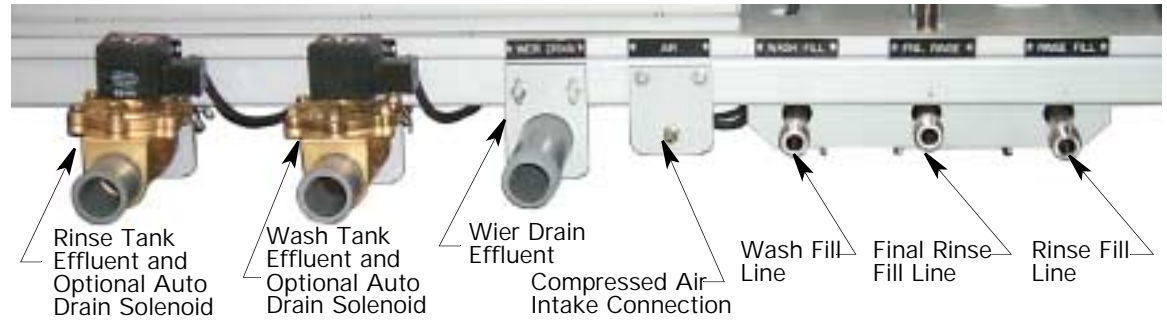

Figure 2–15



Figure 2–16

Section J: Exhaust

Machine Venting

Introduction

The exhaust vent mounted on the top left of the machine top bulkhead contains air vents. When attaching the external blower exhaust tube, ensure air circulation through the vents is not impaired.

Safety

To ensure personal safety and avoid equipment damage, observe the following:



ATTENTION

Do not cover external air vents. If vents are covered during AquaJet™ drain cycles, a vacuum can develop making it difficult to open the front access door.

Photograph

Figure 2–17 shows the exhaust venting system.



Figure 2–17

Section K: Options

Enhancements

Introduction

Several options enhance AquaJet™ system operation. The options listed below are discussed in detail in the AquaJet™ Options Guide:

- Keyswitch password protection
 - Lighted status tower
 - Board rail enhancements
 - Mounting rack
 - Basket rack
 - Nozzles and pumps
 - Hurricane Jet™ nozzles
 - Delta nozzles
 - Pump upgrade
 - Auto drain
 - Blower Enhancements
 - Electrosonic™ airknives
 - Blower upgrades
 - Blower fail detect
 - Flow meter
 - pH monitor
 - Resistivity meter
 - Bag filter
 - Saponifiers
 - Detergent injection
 - Drum pump chemical transfer
 - Heavy metals tank
 - Sump pump
-

Operating Controls

Overview

Introduction

This chapter describes the AquaJet™ operating controls.

In this chapter

This chapter consists of the following

Topic	See Page
Control Panel Layout	A
Pressure Gauges	B
LCD Touch Pad Unit	C
Audible Alarms	D
Emergency Stop Button	E

Section A: Control Panel Layout

Controls Description

Introduction

The AquaJet™ Control Panel includes the following:

- LCD Touch Pad Unit
 - Audible Alarm Speaker
 - Emergency Stop Switch
 - Wash/Rinse or optional Hurricane Pressure Gauge
 - Final Rinse/Purge Pressure Gauge
-

Photograph

Figure 3–1 shows the control panel layout and identifies the controls:

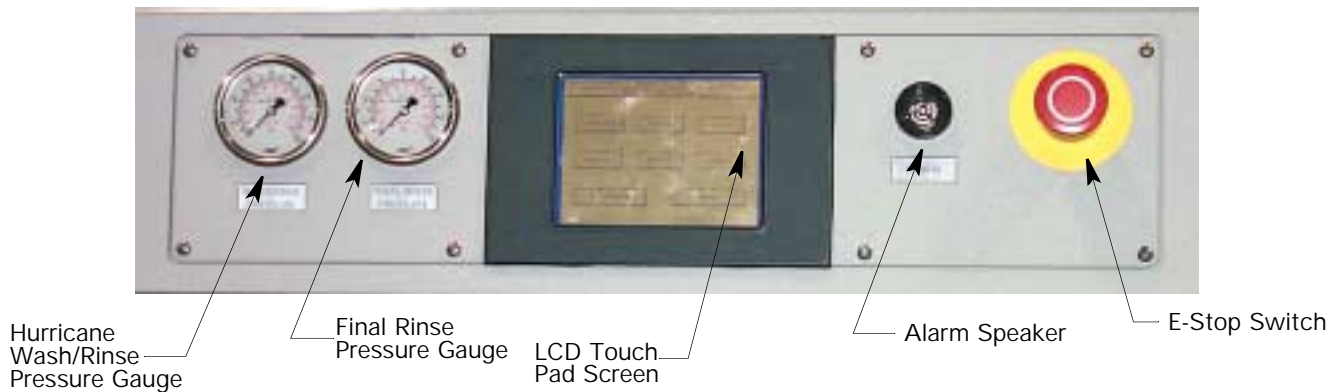

Figure 3–1

Section B: Pressure Gauges

Water Pressure

Introduction

The control panel gauges display the water pressure in the Wash/Rinse or optional Hurricane™ cycles and optional Final Rinse/Purge cycles. Actual pressure rating depends on the pump horsepower rating. The table lists average pressure readings for the pumps.

Photograph

Figure 3–2 displays a close up view of the pressure gauges:



Figure 3–2

Pressure Checks

On 3 or 7.5 hp pumps, if the pressure increases by 138 kPa (5 psi) check and clean the Vee Jet™ or optional Hurricane Jet™ nozzles.

Table

Refer to the following table for standard gauge panel readings:

Pump Rate	Pressure Reading
3 hp	345 kPa (50 psi)
7.5 hp	427.8 kPa (62 psi)

Section C: LCD Touch Pad Unit

Overview

Introduction

This section displays the touch screen display and describes the touch pad screens.

In this section

Refer to the following information:

Topic	See Page
Touch Screen Display	3 – 39
Touch Pad Screens	3 – 40

Touch Screen Display

Introduction

The LCD (Liquid Crystal Display) touch pad screen displays system information and allows the operator to control system operation and perform set up procedures for the following functions.

- Recipe Definition
- System Configuration
- Alarm Process
- Preventive Maintenance

Photograph

Figure 3–3 shows the touch screen display unit and AquaJet™ Main Screen:

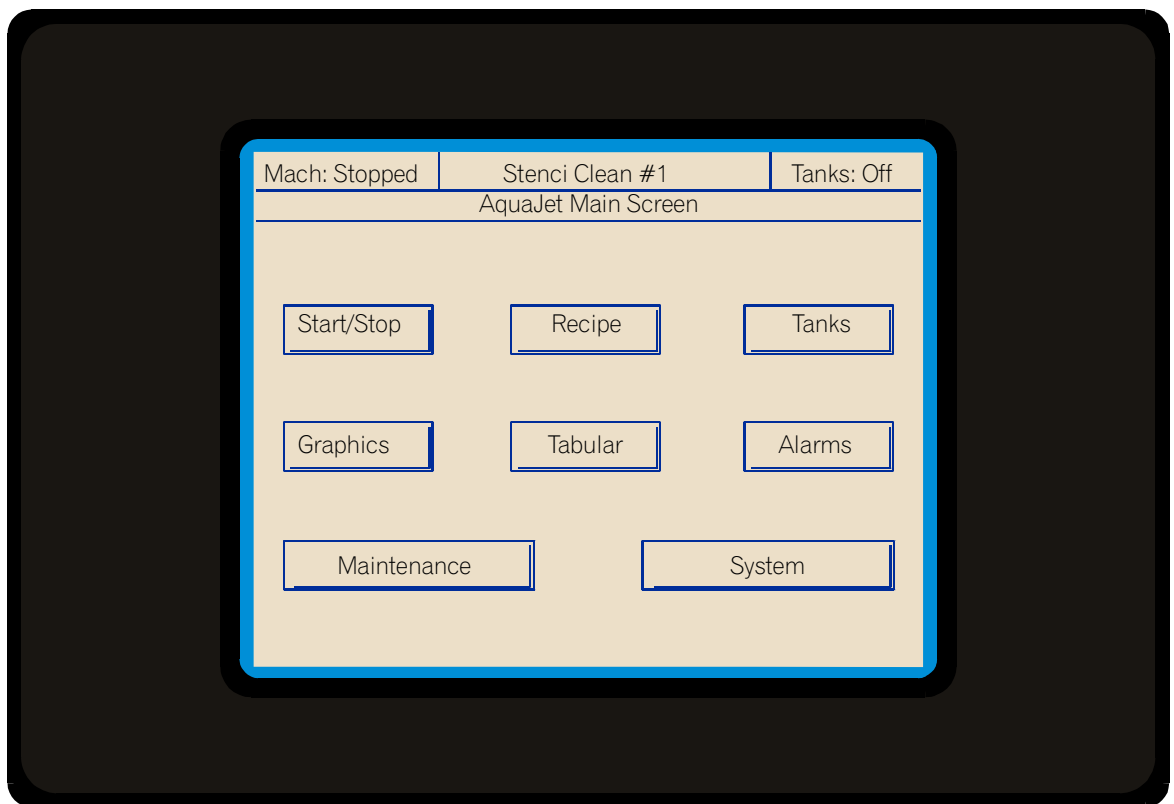

Figure 3–3

Touch Pad Screens

Introduction

The following touch pad screens convey operation information or provide operator interface for system set up.

- Main Screen
- Recipe Screens
- Graphics Screens
- Tabular Screens
- Alarms Screen
- System Configuration
- Maintenance Screens

Main Screen

The Main screen displays the top level buttons that guide the user through system set up, alarms, operation, graphics, and maintenance.

Start/Stop Button	Displays Mach:Starting, Mach:Running, Mach:Stopping, or Mach:Stopped to indicate current machine status.
Tanks Button	Displays Tanks:Off, Tanks:On to indicate current wash/rinse tank status.

Recipe Screens

The Recipe button displays the predefined list of configured AquaJet™ recipes.

Tabular Screens

The Tabular button accesses the Tabular Process screens to display the parameters associated with the current recipe and cycle.

Graphics Screens

The graphics screens show the recipe cycle status graphically. For each cycle defined in a recipe, a different graphic screen displays and lists parameters associated with the current recipe and cycle.

Alarms Screen

The alarms button displays active alarms and their status. The operator clears an alarm using this screen.

System Configuration

The System screen displays the configuration, thermocouple, and Recipe Edit buttons.

Configure Options	Program the system software to recognize system options.
Configure Units	Set the display units for temperature readout.
Configure Alarms	Set system alarms and indicate their priority.
Recipe Edit	Define recipe parameters for specific process applications.
Thermocouples	Displays thermocouple calibration information for wash, rinse, chamber, and final rinse resistivity.

Maintenance Screens

The Maintenance button displays three (3) maintenance screens. The operator turns system functions On and Off as required for preventive maintenance.

Section D: Audible Alarms

Alarm Speaker

Introduction

Configure process alarms with Warning, SoftStop, HardStop, or Ignore actions. Process alarms configured as Ignore do not activate an alarm. Process alarms configured as Warning, SoftStop, or HardStop initiate an audible alarm. When an audible alarm sounds, touch the screen to stop the alarm sound.

Photograph

Figure 3–4 shows a close up view of the audible alarm speaker:



Figure 3–4

Hardware Alarms

Hardware alarms are fixed within the system and always initiate an audible alarm. In the alarm list, items marked with an asterisk are hardware related and not user programmable.

Location	Type of Alarm
Wash/Rinse Cycle/Final Rinse	Wash/Rinse Tank High Level * Wash/Rinse Tank Low Level * Wash/Rinse Temperature Final Rinse Resistivity Wash/Rinse/Final Rinse Flow Wash/Rinse/Final Rinse Pressure
Dryer Cycle	Machine High Temperature *
Other Alarms	Emergency Stop * Conveyor Fault * Door Open * End of Process Cycle

Section E: Emergency Stop Button

E-Stop

Introduction

One (1) large red push-pull button allows the operator to halt system operation in the event of an emergency. Pressing the button stops process operation. The computer, LCD touch screen, and 24 V power supply remain operational.

Safety

To ensure personal safety and avoid equipment damage, observe the following:



Electrical Hazard

Risk of Electric Shock – Turning power Off using the Emergency Stop (E-Stop) control DOES NOT disable power to the system. To disable system power turn Off power at the main disconnect and facility power safety disconnect.

Photograph

Figure 3–5 shows the emergency stop button.



Figure 3–5

Start Up and Shut Down

Overview

Introduction

This chapter describes the steps for AquaJet™ daily operation start up and shutdown.

In this chapter

This chapter consists of the following:

Topic	Section
Start Up	A
System Shut Down	B

Section A: Start Up

Overview

Introduction

This section identifies the steps required to begin AquaJet™ daily operation.

In this section

Refer to the following information:

Topic	See Page
Set Up Checklist	4 – 45
Electrical Power	4 – 46
Wash and Rinse Tank Reservoirs	4 – 47
Load Recipe	4 – 49
Verify Operation Parameters	4 – 50
Load Chamber with Product	4 – 52

Set Up Checklist

Introduction

Prior to initial start up or daily AquaJet™ operation, perform the following system checks.

Table

Refer to the following table prior to beginning system operation:

Electrical Cabinet	Carriage Assembly
<ul style="list-style-type: none"> <input type="checkbox"/> Rear electrical enclosure doors are closed, latched and locked in place <input type="checkbox"/> Electrical door keys are stored in a safe place 	<ul style="list-style-type: none"> <input type="checkbox"/> Chain moves freely and does not encounter any obstructions <input type="checkbox"/> Rear conveyor motor housing is in place
AquaJet™ to Facility Connections	Chamber
<ul style="list-style-type: none"> <input type="checkbox"/> AquaJet™ electricity connected to facility electricity and facility electricity is turned On <input type="checkbox"/> AquaJet™ drains to facility drains <input type="checkbox"/> AquaJet™ compressed air to facility air supply and compressed air is turned On <input type="checkbox"/> AquaJet™ water inlet to facility water supply and water supply is turned On <input type="checkbox"/> AquaJet™ exhaust to facility exhaust tube and exhaust is turned On <input type="checkbox"/> AquaJet™ optional final rinse inlet to facility optional DI water supply and DI water supply is turned On 	<ul style="list-style-type: none"> <input type="checkbox"/> Chamber is clean and free of debris <input type="checkbox"/> Water and air supply hoses move freely <input type="checkbox"/> Mounting rail manual adjust wheel turns freely
	Access Panels and Cabinet
Wash Reservoir	Rinse Reservoir
<ul style="list-style-type: none"> <input type="checkbox"/> Wash tank drain catch screen is clean, free of debris, and in place <input type="checkbox"/> Wash tank chamber drain tray is in place <input type="checkbox"/> Wash tank lid is in place <input type="checkbox"/> Reservoir is filled and at operating temperature 	<ul style="list-style-type: none"> <input type="checkbox"/> Rinse tank drain catch screen is clean and free of debris <input type="checkbox"/> Rinse chamber drain catch screen is in place <input type="checkbox"/> Rinse tank lid is in place <input type="checkbox"/> Reservoir is filled and at operating temperature

Electrical Power

Introduction

Turn the main power switch on the rear electrical panel of the machine to the On position to activate or enable the following AquaJet™ system functions:

- Computer boots up
- Touch pad illuminates and displays the Main Screen
- High temperature monitor on the West 6700 in the electrical enclosure
- Tank heaters activate if tanks are at operating levels
- Auto fill solenoids activate
- Optional drain solenoids activate
- Optional light tower flashes

Turn the main power switch to the Off position to disable AquaJet™ functions.

- The touch screen unit display turns Off
- Any operating subsystems immediately shut Off

Safety

To ensure personal safety and avoid equipment damage, observe the following:



Electrical Hazard

Risk of Electric Shock – To disable all system power, turn Off power at the main power switch and facility power safety disconnect and perform lock-out tag-out steps. Refer to Lock-Out Tag-Out on page 10.

Photograph

Figure 4–1 shows the AquaJet™ main power switch set to the On position. The switch is located on the rear electrical panel of the machine:



Figure 4–1

Wash and Rinse Tank Reservoirs

Introduction

The operator must fill the tanks when starting the AquaJet™ for the first time or when a tank has been drained for maintenance purposes.

Safety

To ensure personal safety and avoid equipment damage, observe the following:



CAUTION

To avoid immersion heater damage, tank liquid level must be above the low level float switch before immersion heaters turn On.

Diagram

Figure 4–2 shows the AquaJet™ main screen.

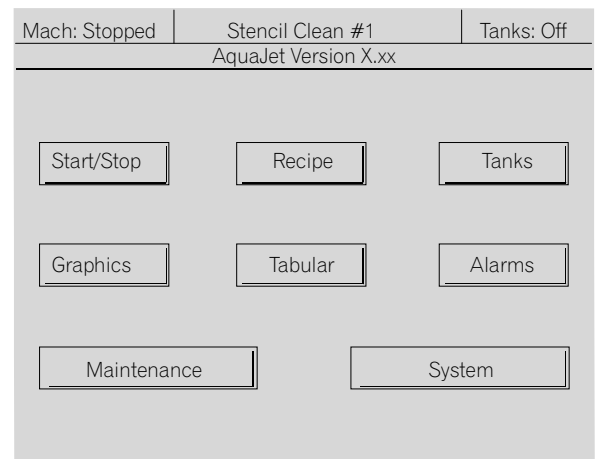

Figure 4–2

Procedure

To automatically fill tanks and heat water:

1. Touch the Tanks button on the Main Screen.
2. Ensure Tanks:On displays in the upper right corner.
3. The fill cycle initiates.
4. When the wash or rinse tank water level reaches the operating level float switch, the fill solenoid turns Off.
5. When the tank level passes the low level float switch, the immersion heaters begin heating.
6. Water is only added to the tanks when the water level drops below the operating level float switch and the pumps are turned Off.
7. When the wash and rinse tank water level and temperature reach operating levels, Tanks:Ready displays in the upper right corner of the Main Screen.

Procedure

Use the following steps to ensure the machine is ready to accept product and begin daily operation:

1. Ensure the main power switch is in the On position.
 2. Ensure the chamber door is closed and latched.
 3. Ensure the correct recipe is loaded.
 4. Ensure the wash tank and rinse tank are full and at operating temperature.
 5. Touch the Tanks button on the Main Screen.
 6. Ensure Tanks:On displays in the upper right corner.
-

Load Recipe

Introduction

The Recipe screen lists the predefined recipes available for cleaning.

Photograph

Choose an operating recipe from the Recipe Load Screen shown in Figure 4–3.

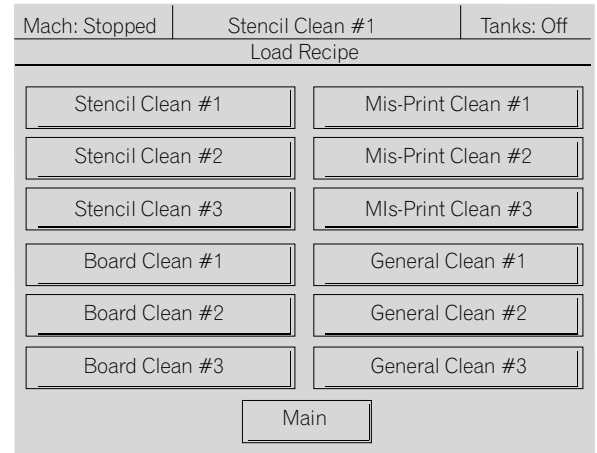

Figure 4–3

Procedure

Use the following steps to choose a recipe:



ATTENTION

For a complete list of recipe default values refer to Predefined Recipes on page 88.

1. Ensure the main power switch is in the On position.
2. Ensure chamber door is closed and latched.
3. Touch the Recipe button on the Main Screen to display the Load Recipe screen.
4. Touch the predefined recipe number for the specific process required.
5. Touch the Main button at the bottom to return to the Main Screen.

Verify Operation Parameters

Introduction

The tabular process screens and graphic process screens show the chosen recipe parameters for each cycle.

Diagrams

Figure 4–4 shows the first tabular process screen and Figure 4–5 shows the wash cycle graphic screen.

Mach: Stopped		Stencil Clean #1		Tanks: Off	
Tabular Process					
Recipe Parameter	Set Point	Actual			
Conveyor Speed		Off			
Passed: Wash	8	0	0:00		
Passed: Airknife	2	0	0:00		
Passed: Rinse	5	0	0:00		
Passed: Final Rinse	2	0	0:00		
Passed: Dry	5	0	0:00		
Passed: Idle	0	0	0:00		
Passed: Idle	0	0	0:00		
Passed: Idle	0	0	0:00		
Passed: Idle	0	0	0:00		
Wash Temperature	150F	32F	===		
Rinse Temperature	150F	32F	0:00		

Figure 4–4

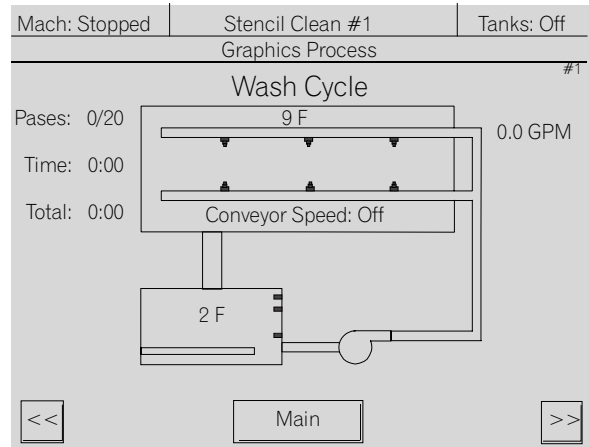

Figure 4–5

Procedure

Use the following steps to review and verify operating parameters for the currently loaded recipe:

1. To view conveyor speed, temperature readings, and recipe cycle status touch the Tabular button to display the Tabular Process screen.
 - Conveyor speed and water temperature display in the Set Points and Actual columns.
 - The time display in the far right column indicates the time each cycle takes.
 - As each cycle processes, the time display increments showing how long the cycle runs.
 2. Touch the right double arrow buttons to view the second tabular process screen.
 3. Touch the Main button at the bottom to return to the Main Screen.
 4. Alternately, from the Main Screen, touch the graphics screen to view the information graphically.
 - Conveyor speed and water temperature display in the chamber graphic.
 - Tank water temperature displays in the tank graphic.
 - Passes completed displays to the left and the predefined number of passes displays to the right.
 - The time display indicates the time the cycle takes.
 - The total display increments showing the cycle run time.
 - The recipe defined flow rate for the specific cycle in gpm units.
 5. Touch the right or left double arrow buttons to view the next or previous graphics screen.
 6. Touch the Main button at the bottom to return to the Main Screen.
-

Load Chamber with Product

Introduction

Ensure machine operation has been started and the required recipe is loaded.

Photograph

Figure 4–6 shows the AquaJet™ with the chamber door open and identifies the rails where product rests during processing. Figure 4–7 shows the front right corner of the machine where the manual adjust wheel is located. Pull the wheel handle knob out to turn the wheel and adjust the board rails to fit product for processing.

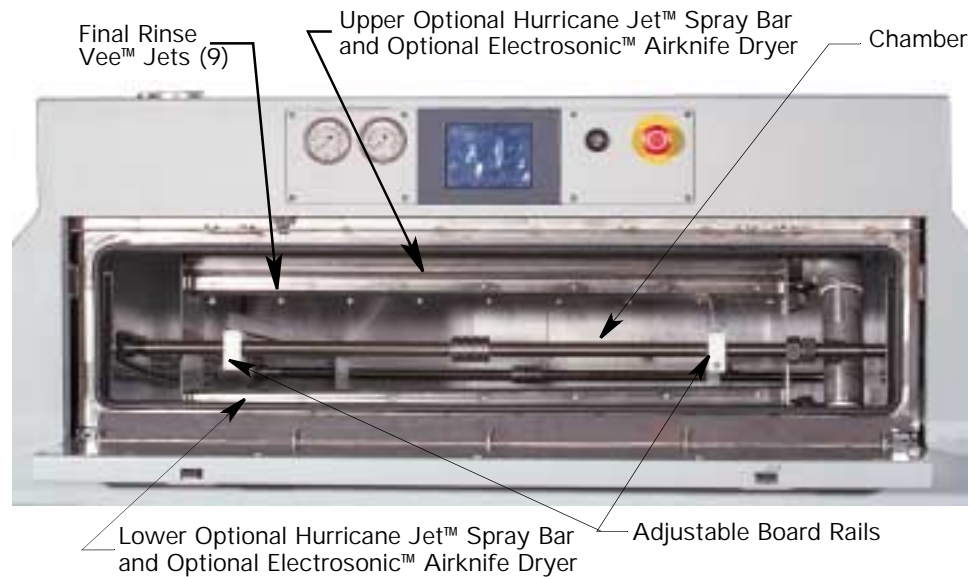

Figure 4–6



Figure 4–7

Procedure

Use the following steps to place product into the AquaJet™ chamber for processing:

1. Open the chamber door.
 2. If necessary, use the manual adjust wheel on the rinse side of the machine to adjust the board rails to fit the product scheduled for processing.
 - Turn the manual adjust wheel clockwise to increase the distance between the rails.
 - Turn the manual adjust wheel counterclockwise to decrease the distance between the rails.
 3. Load product for processing.
 4. Close and latch the chamber door.
 5. Touch the Start/Stop button on the Main Screen.
 6. Ensure Mach:Starting displays in the upper left corner.
 7. The recipe activates and Mach:Running displays in the upper left corner when the system begins processing product using the current recipe.
-

Section B: System Shut Down

Overview

Introduction

This section identifies the steps required to stop AquaJet™ operation.

In this section

Refer to the following hazard descriptions

Topic	See Page
Normal Shut Down	4 – 55
Emergency Shut Down	4 – 56

Normal Shut Down

Introduction

Shut down the AquaJet™ at the end of the work day or to perform preventive maintenance.

Photograph

Figure 4–8 shows the AquaJet™ main screen:

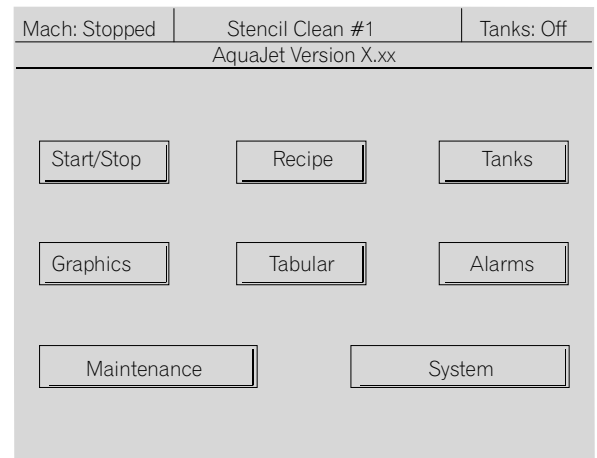

Figure 4–8

Procedure

Use the touch pad unit to stop machine operation:

1. Ensure the current recipe has completed its cycle.
2. Touch the Tabular or Graphic button to verify recipe status.
3. Touch the Main button at the bottom to return to the Main screen.
4. Touch the Tanks button on the Main Screen to display Tanks:Off in the upper right corner.
5. Touch the Start/Stop button on the Main Screen to stop machine operation.
6. Mach:Stopping displays in the upper left corner.
7. Mach:Stopped displays as soon as all operations stop functioning.
8. Open the chamber door and remove any product from the chamber.
9. Turn the main power switch to the Off position.

Emergency Shut Down

Introduction

Pressing the Emergency Stop (E-Stop) immediately stops all AquaJet™ processing. Any PCB assemblies in process could be damaged or adversely affected when the system is stopped in this manner.

Safety

To ensure personal safety and avoid equipment damage, observe the following:



CAUTION

Use the Emergency Stop (E-Stop) control only in response to situations that place operators or equipment in danger. DO NOT use E-Stop control to routinely shut the system down. This causes line surges and could affect machine performance.



ATTENTION

The computer, LCD touch screen, and 24V power supply remain operational when the E-Stop is pressed.

Photograph

Figure 4–9 shows the control panel and identifies the E-Stop button:



Emergency Stop (E-Stop)

Figure 4–9

E-Stop conditions

The following conditions constitute an emergency situation and completely shut down system operation:

- Depressing the E-Stop switch
- An immersion heater reaches high temperature shut down mode
- Front chamber door is open

Restart the machine

Prior to turning power On and resuming operation, correct the emergency situation and ensure the emergency stop switch is pulled to the Out position.

Advanced Operations

Overview

Introduction

This chapter describes advanced electrical and software configuration steps for system administrators.

In this chapter

This chapter consists of the following:

Topic	Section
System Configuration Screens	A
Maintenance Screens	B
Temperature Control Unit	C
Software Upgrade	D

Section A: System Configuration Screens

Overview

Introduction

This section describes the configuration process for system administrators.

In this section

Refer to the following information

Topic	See Page
System Screens	5 – 59
Configure Alarms	5 – 61
Configure Units	5 – 64
Configure Options	5 – 65

System Screens

Introduction

The System screens display the Configuration and Recipe Edit buttons, the Thermocouple reference buttons, and the final rinse resistivity calibration.

Safety

To ensure personal safety and avoid equipment damage, observe the following:



ATTENTION

Actual thermocouple calibration is set at the factory. Access the Cal Wash, Rinse, and Chamber T/C thermocouple calibration screens from System Screen #2. These thermocouple calibration screens display the machine voltage at two (2) temperature readings. If any component replacements are required in the electrical panel, or a touch screen is replaced, the installing technician will re-calibrate the machine during installation.

Diagrams

Figure 5–1 shows the first system screen:

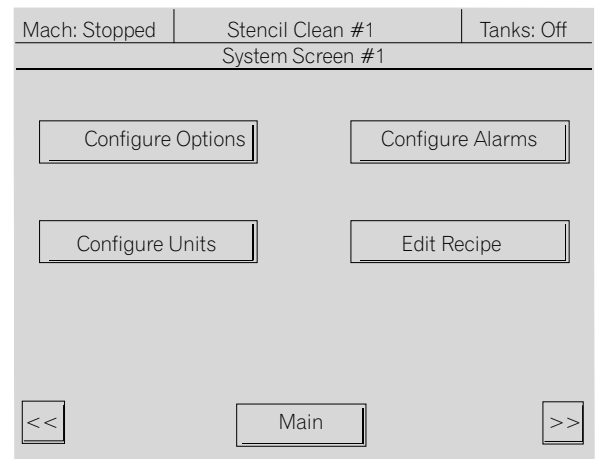

Figure 5–1

Diagram

Figure 5–2 and Figure 5–3 show the second and third system screens:

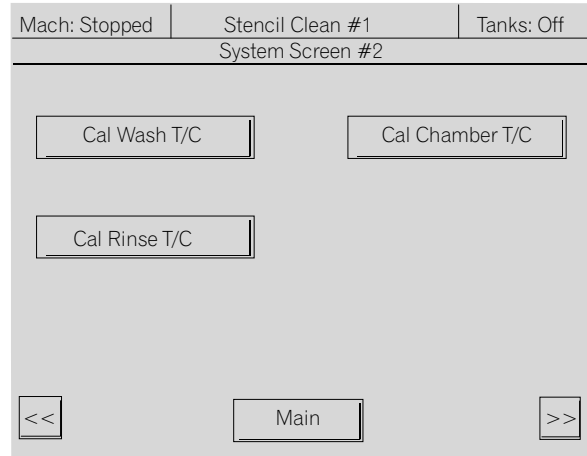

Figure 5–2

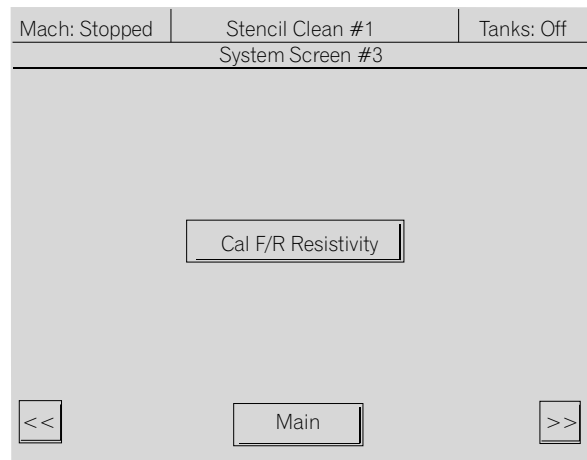

Figure 5–3

Procedure

Use the following steps to access the System Screens:

1. Ensure the main power switch is in the On position.
2. Ensure chamber door is closed and latched.
3. Touch the System button on the AquaJet™ Main screen.
4. Touch the right or left double arrow button to display the second and third System screens.
5. Review the thermocouple temperature for the wash, rinse, or spray chamber as required.
6. Touch the Main button at the bottom to return to the Main Screen.

Configure Alarms

Introduction

Set system alarms and indicate their priority level from this button. Configure process alarms with Warning, SoftStop, HardStop, or Ignore actions. Process alarms configured as Ignore do not activate an alarm. Process alarms configured as Warning, SoftStop, or HardStop initiate an audible alarm.

Set the following system alarms as required for the specific process:

- Wash/Rinse Temperature
- End of Process Cycle
- Final Rinse Resistivity
- Wash/Rinse Flow Rate
- Final Rinse Flow Rate

Diagram

Figure 5–4 shows the temperature alarm configuration screen:

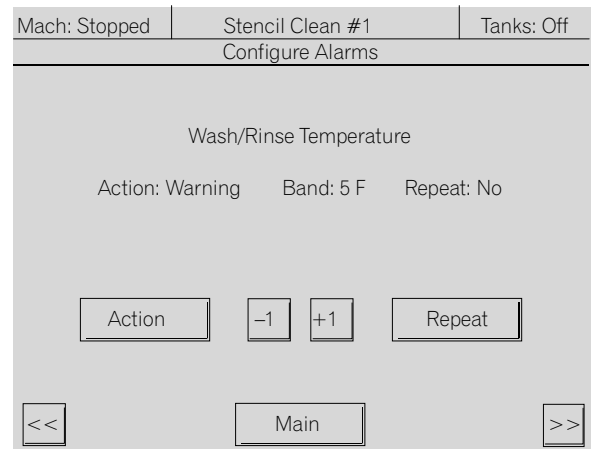

Figure 5–4

Procedure

Use the following steps to configure temperature alarms:

1. Ensure the main power switch is in the On position.
 2. Ensure chamber door is closed and latched.
 3. Touch the System button on the AquaJet™ Main screen.
 4. Touch the Configure Alarms button on the system screen.
 5. The Wash/Rinse Temperature configuration screen displays.
 6. Touch the Action button to toggle between alarm actions until the desired alarm action displays.
 - **IGNORE** – No alarm or LCD display activates.
 - **WARNING** – An audible alarm and LCD display activate. The system remains operational.
 - **SOFTSTOP** – An audible alarm and LCD display activate. The heater and pump stop operating and the conveyor returns to the Home position.
 - **HARDSTOP** – An audible alarm and LCD display activate. The heater and pump stop operating and the conveyor stops where it is when the alarm activates.
 7. Touch the Repeat button to toggle between Yes and No to indicate when an alarm should repeat if it is not corrected when it first activates.
 8. Band indicates the temperature set point deviation level. When the actual reading reaches the set limit in the plus or minus direction, the designated alarm activates. Touch the ± 1 buttons to increase or decrease the Band reading amount from 1 to 20 degrees.
 9. Touch the right double arrow button to display the End of Process Cycle alarm configuration screen.
-

Diagram

Figure 5–5 shows the end of process alarm configuration screen:

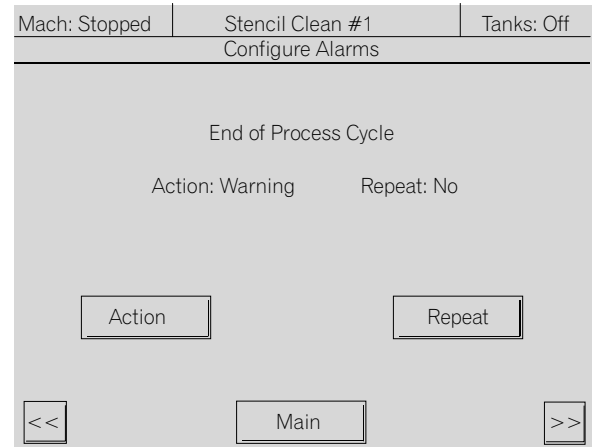

Figure 5–5

Procedure

Use the following steps to configure end of process cycle alarm:

1. Ensure the End or Process Cycle screen displays.
2. Touch the Action button to toggle between alarm actions until the desired alarm action displays.
 - **IGNORE** – No alarm or LCD display activates.
 - **WARNING** – An audible alarm and LCD display activate. The system remains operational.
 - **SOFTSTOP** – An audible alarm and LCD display activate. The heater and pump stop operating and the conveyor returns to the Home position.
 - **HARDSTOP** – An audible alarm and LCD display activate. The heater and pump stop operating and the conveyor stops where it is when the alarm activates.
3. Touch the Repeat button to toggle between Yes and No to indicate when an alarm should repeat if it is not corrected when it first activates.
4. Touch the right double arrow button to display the optional final rinse resistivity alarm configuration screen.
5. Repeat Step 2. through Step 4. to set up the following alarms:
 - Optional final rinse resistivity.
 - Wash/rinse flow rate alarm.
 - Optional final rinse flow rate alarm.
6. Touch the Main button at the bottom to return to the Main Screen.

Configure Units

Introduction

Set the display units for temperature measurement from this button.

Diagram

Figure 5–6 shows the units configuration screen:

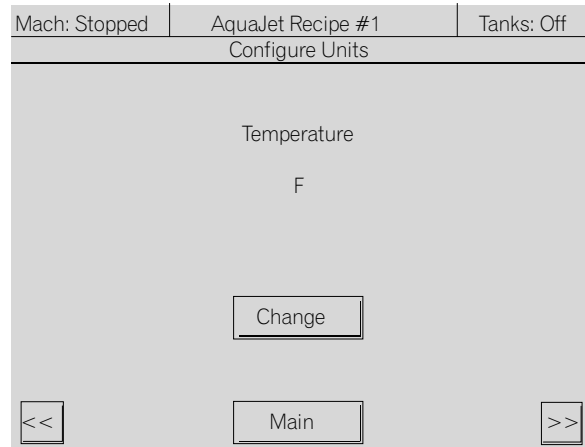

Figure 5–6

Procedure

To configure temperature measurement:

1. Ensure the main power switch is in the On position.
 2. Ensure chamber door is closed and latched.
 3. Touch the System button on the AquaJet™ Main screen.
 4. Touch the Configure Units button on the system screen.
 5. Touch the Change button to toggle between Celsius and Fahrenheit temperature measurement.
 6. Touch the right double arrow button to display the flow rate units configuration screen.
 7. Touch the Change button to toggle between GPM and LPM measurements.
 8. Touch the Main button at the bottom to save the unit configuration information and return to the Main Screen.
-

Configure Options

Introduction

Touch this button to program the software to recognize the options included with the system. The configuration screen interfaces with the system software. When an option is added to the system or removed from the system, the operator adds, or removes the option(s) on the configuration screens.

Safety

To ensure personal safety and avoid equipment damage, observe the following:



CAUTION

System software may lock up if the operator attempts to configure items that do not exist on the system.



ATTENTION

For detailed information on options and their operation refer to the AquaJet™ Options Guide.

Diagram

Figure 5–7 shows an options configuration screen:

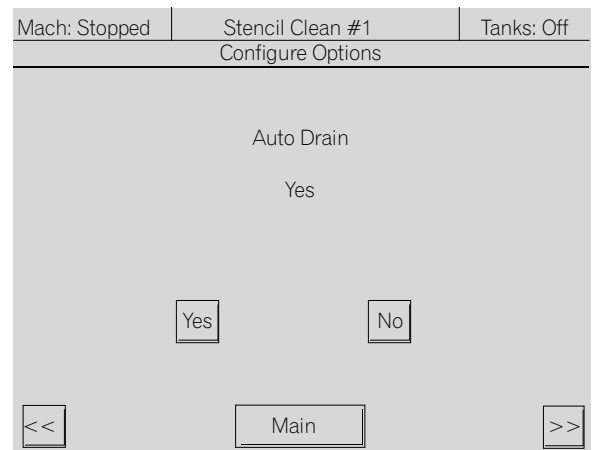

Figure 5–7

Procedure

Use the following steps to configure system options:

1. Ensure the main power switch is in the On position.
 2. Ensure chamber door is closed and latched.
 3. Touch the System button on the AquaJet™ Main screen.
 4. Touch the Configure Options button on the system screen.
 5. Touch the Yes or No button to indicate which of the following options is installed:
 - Auto Drain
 - Rinse Resistivity
 - Final Rinse Resistivity
 - Wash/Rinse Flow Sensor
 - Wash/Rinse Pressure Sensor
 - Final Rinse Flow Sensor
 - Final Rinse Pressure Sensor
 - Wash Tank Auto Fill
 - Rinse Tank Auto Fill
 - Chemical Injection
 6. Touch the right double arrow button to display the options in sequence.
 7. Touch the left double arrow button to display previous screens.
 8. Touch the Main button at the bottom to return to the Main Screen.
-

Section B: Maintenance Screens

Overview

Introduction

This section describes the maintenance screens and how system administrators use them.

In this section

Refer to the following information

Topic	See Page
Maintenance Screens	5 – 68
Watch Dog Test	5 – 70
Debug Process	5 – 72

Maintenance Screens

Introduction

The Maintenance touch button accesses three (3) maintenance screens. The operator turns various system functions On and Off as required for maintenance purposes.

Use these steps during preventive maintenance procedures and to test specific items before returning to normal system operation. Refer to the AquaJet™ Preventive Maintenance Guide for detailed maintenance procedures.

Diagrams

Figure 5–8 shows the first maintenance screen and Figure 5–9 shows the second maintenance screen.

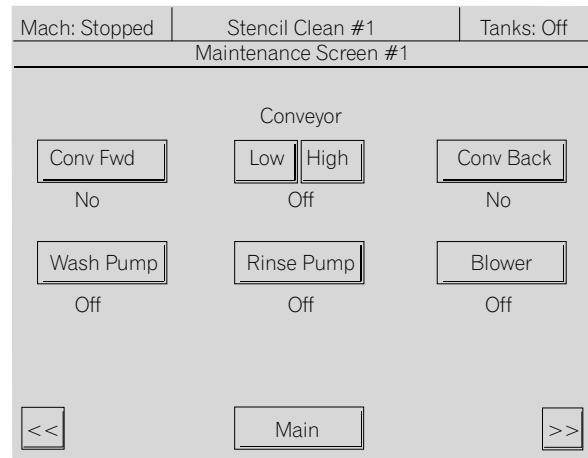

Figure 5–8



Figure 5–9

Diagram

Figure 5–10 shows the third maintenance screen.

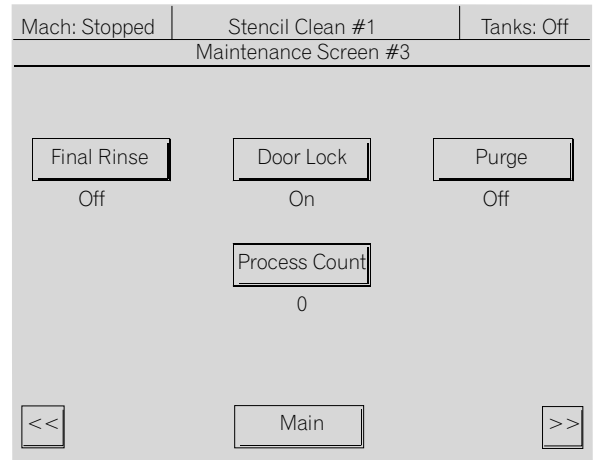

Figure 5–10

Procedure

Use the following steps to view maintenance screens:

1. Ensure the main power switch is in the On position.
2. Touch the Maintenance button on the AquaJet™ Main screen.
3. Touch the right double arrow button to display Maintenance Screen #2 and #3.
4. Touch the left double arrow button to display previous screens.
5. Touch the Main button at the bottom to return to the Main screen.

Watch Dog Test

Introduction

The watch dog test is a software utility that re-boots the internal computer system in the case of a lock up.

Diagram

Figure 5–11 shows the watchdog timer test screen. Figure 5–12 shows the watchdog test progress screen.

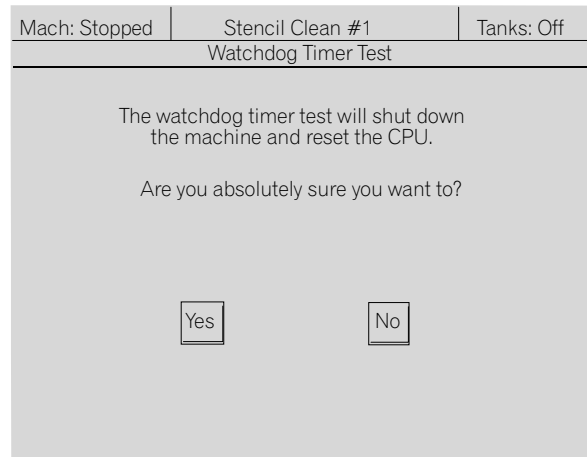

Figure 5–11

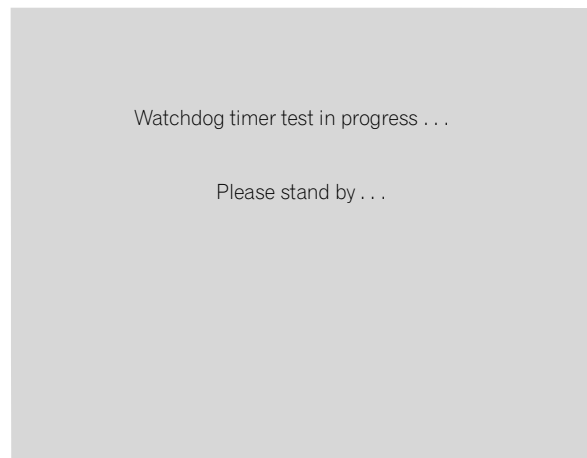

Figure 5–12

Diagram

Figure 5–13 shows AquaJet™ Screen. This screen briefly displays when the machine is first turned on or to indicate the watch dog test is complete. Refer to this screen to view the software version currently loaded on the system.



Figure 5–13

Procedure

Use the following steps to perform the watch dog test:

1. Ensure the main power switch is in the On position.
 2. Ensure chamber door is closed and latched.
 3. Touch the Maintenance button on the AquaJet™ Main screen.
 4. Touch the right or left double arrow button to display Maintenance Screen #2.
 5. Touch the Wd Test button on Maintenance Screen #2.
 6. The Watchdog Timer Test screen displays.
 7. Touch No to return to the Main screen.
 8. Touch Yes to continue and reboot the system.
 9. The Watchdog test progress screen displays.
 10. The system shuts down and displays a blank screen while the computer reboots.
 11. The AquaJet™ Screen displays briefly and the Touch Pad returns to the Main screen.
 12. Resume system operation.
-

Debug Process

Introduction

The Debug touch button accesses three (3) Debug Data Screens. For detailed debug operation refer to the AquaJet™ Preventive Maintenance Guide or AquaJet™ Repair Guide.

Diagrams

Figure 5–14 shows the Main Debug Data Screen. Figure 5–15 shows Debug Screen #2.

Mach: Stopped	Stencil Clean #1				Tanks: Off
Debug Data Screen #1					
D1[00]: 0	D1[16]: 0	D0[00]: 0	D0[16]: 0		
D1[01]: 0	D1[17]: 0	D0[01]: 0	D0[17]: 0		
D1[02]: 0	D1[18]: 0	D0[02]: 0	D0[18]: 0		
D1[03]: 0	D1[19]: 0	D0[03]: 0	D0[19]: 0		
D1[04]: 0	D1[20]: 0	D0[04]: 0	D0[20]: 0		
D1[05]: 0	D1[21]: 0	D0[05]: 0	D0[21]: 0		
D1[06]: 0	D1[22]: 0	D0[06]: 0	D0[22]: 0		
D1[07]: 0	D1[23]: 0	D0[07]: 0	D0[23]: 0		
D1[08]: 0	D1[24]: 0	D0[08]: 0	D0[24]: 0		
D1[09]: 0	D1[25]: 0	D0[09]: 0	D0[25]: 0		
D1[10]: 0	D1[26]: 0	D0[10]: 0	D0[26]: 0		
D1[11]: 0	D1[27]: 0	D0[11]: 0	D0[27]: 0		
D1[12]: 0	D1[28]: 0	D0[12]: 0	D0[28]: 0		
D1[13]: 0	D1[29]: 0	D0[13]: 0	D0[29]: 0		
D1[14]: 0	D1[30]: 0	D0[14]: 0	D0[30]: 0		
D1[15]: 0	D1[31]: 0	D0[15]: 0	D0[31]: 0		
<<		Main		>>	

Figure 5–14

Mach: Stopped	Stencil Clean #1				Tanks: Off
Debug Data Screen #2					
A1[00]: 0	0.00	V	Comm:	FAIL	
A1[01]: 0	0.00	V	MsgA:	0/1	
A1[02]: 0	0.00	V	MsgB:	0/7	
A1[03]: 0	0.00	V	MsgC:	0/9	
A1[04]: 0	0.00	V	MsgD:	0/2	
A1[05]: 0	0.00	V	MsgE:	0/17	
A1[06]: 0	0.00	V	MsgF:	0/1	
A1[07]: 0	0.00	V	BL1730:	UNKNOWN	
A1[08]: 0	0.00	V	XP8100:	UNKNOWN	
A1[09]: 0	0.00	V	Master:	V2.09	
			Slave:	V-1	
<<		Main		>>	

Figure 5–15

Diagram

Figure 5–16 shows Debug Data Screen #3.

Mach: Stopped	Stencil Clean #1	Tanks: Off
Debug Data Screen #3		
	Wash	Rinse
AutoFillTimer:	0	0
LowAlarmTimer:	120	120
ManualDrain:	Off	Off
ManualFill:	Off	Off
AutoFill:	Off	Off
TempAlarmTimer:	720	720
Heaters:	Off	Off
TempError:	-114	-110
TempSlope:	20.00	20.00
TempOffset:	6.48	10.74
<<	Main	>>

Figure 5–16

Procedure

Use the following steps to view debug screens:

1. Ensure the main power switch is in the On position.
2. Touch the Maintenance button on the AquaJet™ Main screen.
3. Touch the Debug Data button to view the Debug Data Screens.
4. Touch the right double arrow button to display Debug Data Screen #2 and #3.
5. Touch the left double arrow button to display previous screens.
6. Touch the Main button at the bottom to return to the Main screen.

Section C: Temperature Control Unit

Overview

Introduction

This section describes the West 6700 temperature control safety circuit and its configuration.

In this section

Refer to the following information

Topic	See Page
West 6700 Unit	5 – 75
Configuration Mode	5 – 76
Setup Mode	5 – 78

West 6700 Unit

Introduction

The West 6700 control provides a safety circuit for the AquaJet™ system. It is located on the rear electrical panel. The control unit ships preset from the factory. The following information is provided for reference only. The most common change is to temperature readings, choosing Fahrenheit or Celsius degree display.

Safety

To ensure personal safety and avoid equipment damage, observe the following:



CAUTION

Improper WEST 6700 control adjustment could damage the equipment.



Electrical Hazard

A qualified system administrator with electrical training or a qualified Electrovert service person should install and configure the temperature controller.

Photograph

Figure 5–17 shows the West 6700 unit and identifies its controls.

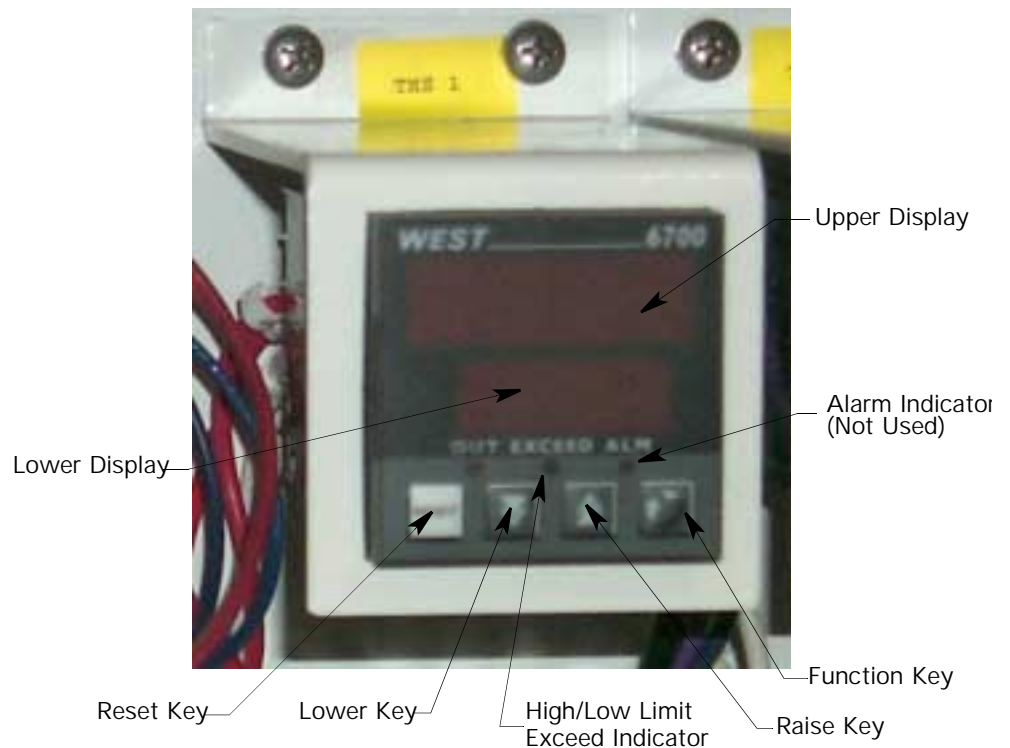

Figure 5–17

Configuration Mode

Introduction

The operator may review configuration values and not make changes. Any change made and saved in the Configuration Mode affects all Setup Mode values. When exiting configuration mode, the four (4) decimal points on the upper digital display illuminate to indicate changes were made and saved. The operator must change setup mode values whenever changes to the configuration mode are made and saved.

Safety

To ensure personal safety and avoid equipment damage, observe the following:



ATTENTION

If no activity occurs in configuration mode for two (2) minutes, the West 6700 automatically exits to Operator Mode.

Diagram

Figure 5–18 shows the configuration mode menu values:

	Values
<i>LnPt</i>	<i>14.18 (F)</i> <i>14.17 (C)</i>
<i>CtrL</i>	<i>16.</i>
<i>ALA1</i>	<i>P.h.</i>
<i>ALA2</i>	<i>P.h.</i>
<i>CJC</i>	<i>EnAb</i>
<i>Loc</i>	<i>10</i>

Figure 5–18

Procedure

Use the following steps to view parameters:

1. Ensure power to the temperature controller is turned OFF.
2. Turn power to controller back ON.
3. Within 30 seconds of activating power to the controller, simultaneously press and hold the Function Key and Raise Arrow keys for approximately five (5) seconds until the lower display reads *inPt*.
4. The operator may step through the configuration mode parameters using the Function Key. The lower display shows a mnemonic parameter identifier. The upper display shows the current value or setting of the parameter.

Procedure

Use the following steps to change parameters.

1. Ensure power to the temperature controller is turned OFF.
 2. Turn power to controller back ON.
 3. Within 30 seconds of activating power to the controller, simultaneously press and hold the Function Key and Raise Arrow keys for approximately five (5) seconds until the lower display reads *inPt*.
 4. Press the Raise or Lower arrow keys to adjust the value or setting. When the value or setting changes, the upper display flashes indicating the new value or setting is not confirmed or saved.
 5. Press the Reset Key to confirm or save the new value or setting.
 6. Repeat Step 4. and Step 5. for the remaining configuration mode values or settings.
 7. To exit Configuration Mode, simultaneously press and hold the Function Key and Raise Arrow keys. The Operator Mode displays.
-

Setup Mode

Introduction

The operator may review configuration values and not make changes. The operator must change setup mode values when changes are made and saved to configuration mode.

Safety

To ensure personal safety and avoid equipment damage, observe the following:



ATTENTION

DO NOT change the value in the *Loc* field.

Diagram

Figure 5–19 shows set up mode menu values:

	Value
SP	230
FILT	2.0
HYST	1
L.A1	21. (F) 100 (C)
h.A2	212 (F) 100 (C)
Loc	10

Figure 5–19

Procedure

Use the following steps to view parameters:

1. After completing all configuration mode settings, ensure the controller remains in Operator Mode for more than 30 seconds.
2. Simultaneously press and hold the Function Key and Raise Arrow keys until the lower display reads *ULoc*.
3. Press the Raise Arrow key until the upper digital display reads *10*.
4. Press the Function Key until *FiLt* displays.

Procedure

Use the following steps to change parameters.

1. Simultaneously press and hold the Function Key and Raise Arrow keys until the lower display reads *ULoc*.
 2. Use the Raise and Lower Arrow keys to enter the values in the set up menu.
 3. Press the Reset Key to confirm or save the new values.
 4. Repeat Step 2. and Step 3. for the remaining setup mode values.
 5. To exit Set Up Mode, simultaneously press and hold the Function Key and Raise Arrow keys.
-

Section D: Software Upgrade

Overview

Introduction

This section describes the system software upgrade package and its configuration.

In this section

Refer to the following information

Topic	See Page
Upgrade Equipment Requirements	5 – 81
I/O Controller Board Software Upgrade	5 – 82
LCD Unit Software Upgrade	5 – 84

Upgrade Equipment Requirements

Introduction

In an effort to enhance AquaJet™ control, the operating software is sometimes upgraded in the field. Install software when an upgrade floppy is received, or in the unlikely event of a computer component failure.

There are two (2) parts to the upgrade process. The I/O controller board located on the rear electrical panel controls the electrical switching portion of the software. The LCD unit on the Control Panel sends the control signals to the I/O controller board.

When connected properly the flashing LED on the I/O controller board flashes randomly and the LCD unit displays a small rotating cursor in the upper right corner. If the rotating cursor stops or does not display and the I/O controller board LED flashes on and off at five (5) second intervals, the electrical connection between the two has been broken. Double check all connections and re-seat them as necessary. If no connection can be made between the LCD unit and the I/O Controller board, contact Electrovert Customer Service.

Safety

To ensure personal safety and avoid equipment damage, observe the following:



Electrical Hazard

A qualified system administrator with electrical training or a qualified Electrovert service person should install and configure the temperature controller.

Requirements

Use the following minimum system and connection information to install a software upgrade.

- Windows based PC with RS232 serial port and 1.44 MB 3.5 in. floppy drive
 - Serial cable with DB9M connector for AquaJet™ controllers
 - AquaJet™ program floppy disk upgrade
 - Phillips screwdriver
-

I/O Controller Board Software Upgrade

Introduction

Access the I/O controller board located on the rear electrical panel to upgrade the electrical switching portion of the software.

Photographs

Figure 5–20 shows a close up of the I/O controller board.

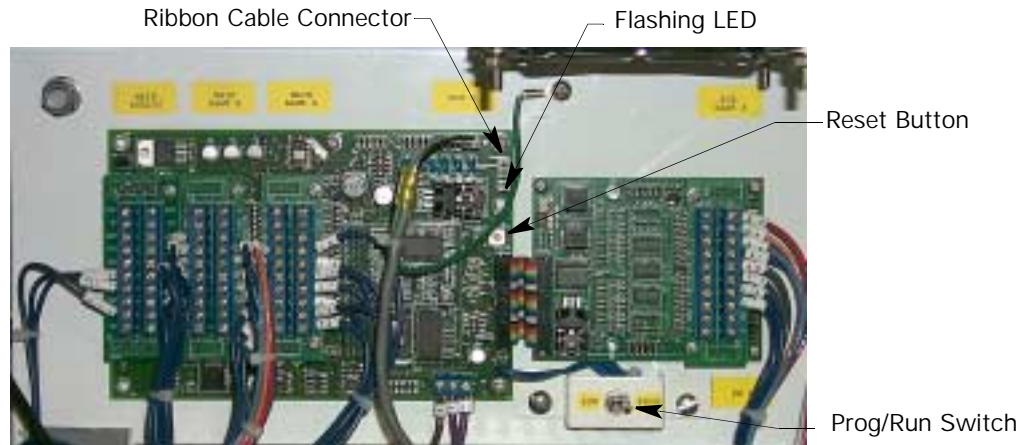

Figure 5–20

Procedure

To connect the Windows based PC to the I/O controller board:

1. Ensure a Windows based PC with RS232 serial port and 1.44 MB 3.5 in. floppy drive is operating near the AquaJet™ system.
 2. Insert the AquaJet™ program floppy disk into the 1.44 MB 3.5 in. floppy drive.
 3. Unlock and open the AquaJet™ system rear electrical panel doors.
 4. Locate the I/O controller board in the upper left corner of the electrical panel.
 5. Connect the I/O controller board ribbon cable to the DB9M serial cable connected to the Windows based PC.
 6. Set the Prog/Run Switch next to the I/O controller board to the Prog position.
 7. Press the reset button next to the LED on the I/O controller board.
-

Photograph

Figure 5–21 shows the Program Loader Main Screen. Figure 5–22 shows the Options Menu Selections required for I/O controller board upgrade.

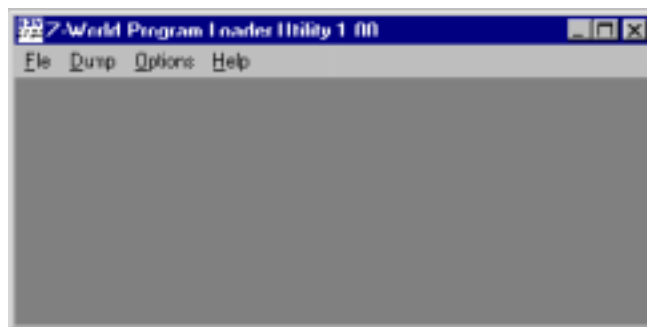

Figure 5–21

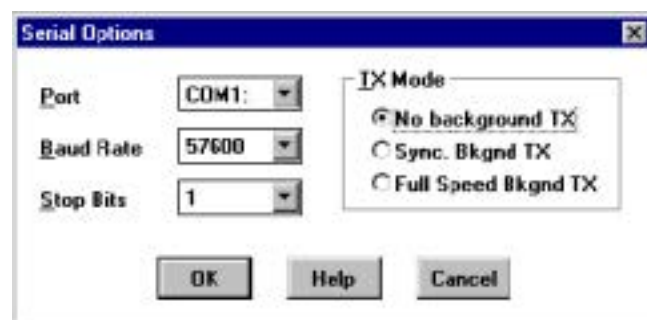

Figure 5–22

Procedure

To install I/O controller board software:

1. Double click on My Computer Icon on the Windows based PC desktop.
2. Double click on the 3.5 in. floppy drive icon.
3. Double click on the file prgloadr.exe to start the Program Loader software.
4. Access the Options drop down menu and highlight serial options to match the Windows based PC.
5. Access the Options drop down menu and highlight Reset Target.
6. Access the File menu to select the file to upload.
7. At the upload menu select the (Flash Only) option.
8. Select the SLAVE.BIN file to initiate I/O controller board upload.
9. Transfer can take several minutes to complete.

Procedure

To disconnect I/O controller board from the Windows based PC:

1. Disconnect the DB9M serial cable connected to the Windows based PC from the I/O controller board ribbon cable.
2. Set the Prog/Run switch next to the I/O controller board to the Run position.
3. Press the reset button next to the LED on the I/O controller board.
4. Move to the front of the machine to program the LCD controller unit.

LCD Unit Software Upgrade

Introduction

Access the back of the LCD unit on the rear of the system main control panel to upgrade the software that sends the control signals to the I/O controller board.

Photographs

Figure 5–23 shows the control panel front view. Figure 5–24 shows a rear view of the LCD Controller Board after removal from the AquaJet™ upper housing.



Figure 5–23

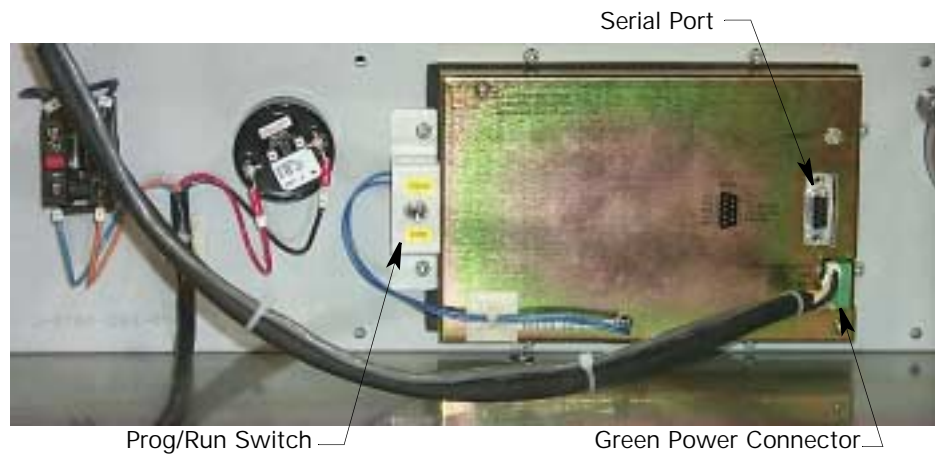

Figure 5–24

Procedure

To access LCD controller connections at the rear of the front control panel and connect to the Windows based PC:

1. Using the phillips screwdriver remove the eight (8) self tapping screws from the front control panel. Set the screws aside in a safe place.
2. Gently remove and turn the control panel around to access the back of the LCD unit.
3. Connect the DB9M serial cable connected to the Windows based PC to the serial port on the back of the LCD unit.
4. Set the Prog/Run Switch next to the LCD unit to the Prog position.
5. Remove and replace the green power connector on the back of the LCD unit.

Photograph

Figure 5–25 shows the Options Menu Selections required for LCD unit upgrade.

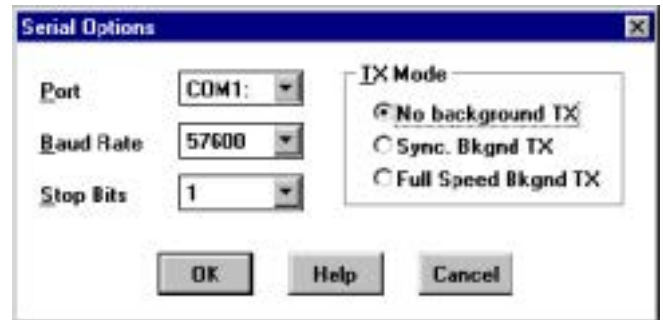

Figure 5–25

Procedure

To install LCD controller software:

1. Return to the Start Program Loader program.
2. Access the Options drop down menu and highlight serial options to match the Windows based PC.
3. Access the Options drop down menu and highlight Reset Target.
4. Access the File menu to select the file to upload.
5. At the upload menu select the (Flash Only) option.
6. Select the MASTER.BIN file to initiate LCD unit upload.
7. Transfer can take several minutes to complete.

Procedure

To disconnect LCD unit from the Windows based PC:

1. Exit the Program Loader software and remove the AquaJet™ upgrade floppy disk from the PC. Store the floppy disk in a safe place.
2. Disconnect the DB9M serial cable connected to the Windows based PC from the back of the LCD unit.
3. Set the Prog/Run switch next to the LCD unit to the Run position.
4. Remove and replace the green power connector on the back of the LCD unit.
5. Replace the front control panel and secure it into place with the eight (8) self tapping phillips screws previously removed.

Procedure

To verify the software upgrade:

1. As soon as the LCD unit upload is complete the system reboots itself.
2. The loading data screen displays briefly, then the AquaJet™ Version screen displays. The version on the display and the upgrade floppy disk should match.
3. Close and latch the electrical panel doors and resume system operation.

Select and Edit Recipes

Overview

Introduction

This section identifies and describes the pre-defined recipes used to process product in the AquaJet™ machine and guides the user in the steps to choose and review the recipe status and information.

In this chapter

This chapter consists of the following:

Topic	Section
Predefined Recipes	A
Edit Recipes	B
Recipes and Parameters	C

Section A: Predefined Recipes

Overview

Introduction

Each AquaJet™ recipe includes predefined processes. The following tables provide a complete list of the predefined recipe types and their default values. Select the predefined recipe that relates to the type of cleaning required. If necessary, make adjustments to enhance the chosen cleaning process.

The Graphics and Tabular Process screens display the parameters associated with a recipe, its set points, actual system readings, and elapsed process time.

Each type of cleaning contains three (3) predefined recipes. Choose one (1) recipe for processing from the Load Recipe screen.

In this section

Refer to the following cleaning recipe descriptions

Topic	See Page
Stencil Cleaning	6 – 89
Circuit Board Cleaning	6 – 90
Mis-Print Cleaning	6 – 91
General Cleaning	6 – 92

Stencil Cleaning

Introduction

The following pre-defined recipes are recommended for cleaning Rosin Mildly Active (RMA), Organic Acid (O/A), and no clean solder paste from stencils and printed circuit boards.

Table

The following table shows the default values for the predefined stencil cleaning recipes:

	Stencil Clean #1		Stencil Clean #2		Stencil Clean #3	
	Cycle/Value	Passes	Cycle/Value	Passes	Cycle/Value	Passes
Conv Speed	Low		Low		Low	
Wash Temp	49 °C (120 °F)		43 °C (110 °F)		43 °C (110 °F)	
Rinse Temp	49 °C (120 °F)		43 °C (110 °F)		43 °C (110 °F)	
Cycle Slot #1	Wash Cycle	8	Wash Cycle	5	Wash Cycle	5
Cycle Slot #2	Purge Cycle	8	Purge Cycle	8	Purge Cycle	8
Cycle Slot #3	Rinse Cycle	5	Rinse Cycle	5	Rinse Cycle	5
Cycle Slot #4	Final Rinse Cycle	2	Final Rinse Cycle	2	Final Rinse Cycle	2
Cycle Slot #5	Dry Cycle	10	Dry Cycle	8	Dry Cycle	8
Cycle Slot #6	Idle Cycle	0	Idle Cycle	0	Idle Cycle	0
Cycle Slot #7	Idle Cycle	0	Idle Cycle	0	Idle Cycle	0
Cycle Slot #8	Idle Cycle	0	Idle Cycle	0	Idle Cycle	0
Cycle Slot #9	Idle Cycle	0	Idle Cycle	0	Idle Cycle	0
Cycle Slot #10	Idle Cycle	0	Idle Cycle	0	Idle Cycle	0
Rinse Resistivity	1500000.0 Ω ohms		1500000.0 Ω ohms		1500000.0 Ω ohms	
Final Rinse Resistivity	1500000.0 Ω ohms		1500000.0 Ω ohms		1500000.0 Ω ohms	
Wash Pressure	Low		Low		Low	
Rinse Pressure	Low		Low		Low	
Wash Flow	45		45		45	
Rinse Flow	45		45		45	
Final Rinse Flow	4.5		4.5		4.5	

Circuit Board Cleaning

Introduction

The following pre-defined recipes are recommended for cleaning Printed Circuit Boards (PCB), bare boards, and complex circuit boards.

Table

The following table shows the default values for the predefined board cleaning recipes:

	Board Clean #1		Board Clean #2		Board Clean #3	
	Cycle/Value	Passes	Cycle/Value	Passes	Cycle/Value	Passes
Conv Speed	HIGH		HIGH		HIGH	
Wash Temp	60 °C (140 °F)		60 °C (140 °F)		60 °C (140 °F)	
Rinse Temp	66 °C (150 °F)		66 °C (150 °F)		66 °C (150 °F)	
Cycle Slot #1	Wash Cycle	20	Wash Cycle	15	Wash Cycle	10
Cycle Slot #2	Purge Cycle	8	Purge Cycle	8	Purge Cycle	8
Cycle Slot #3	Rinse Cycle	8	Rinse Cycle	5	Rinse Cycle	5
Cycle Slot #4	Final Rinse Cycle	2	Final Rinse Cycle	2	Final Rinse Cycle	2
Cycle Slot #5	Dry Cycle	20	Dry Cycle	15	Dry Cycle	10
Cycle Slot #6	Idle Cycle	0	Idle Cycle	0	Idle Cycle	0
Cycle Slot #7	Idle Cycle	0	Idle Cycle	0	Idle Cycle	0
Cycle Slot #8	Idle Cycle	0	Idle Cycle	0	Idle Cycle	0
Cycle Slot #9	Idle Cycle	0	Idle Cycle	0	Idle Cycle	0
Cycle Slot #10	Idle Cycle	0	Idle Cycle	0	Idle Cycle	0
Rinse Resistivity	1500000.0 Ω ohms		1500000.0 Ω ohms		1500000.0 Ω ohms	
Final Rinse Resistivity	1500000.0 Ω ohms		1500000.0 Ω ohms		1500000.0 Ω ohms	
Wash Pressure	High		High		High	
Rinse Pressure	High		High		High	
Wash Flow	58		58		58	
Rinse Flow	58		58		58	
Final Rinse Flow	4.5		4.5		4.5	

Mis-Print Cleaning

Introduction

The following pre-defined recipes are recommended for cleaning solder paste or adhesives from printed circuit boards

Table

The following table shows the default values for the predefined board cleaning recipes:

	Mis-Print Clean #1		Mis-Print Clean #2		Mis-Print Clean #3	
	Cycle/Value	Passes	Cycle/Value	Passes	Cycle/Value	Passes
Conv Speed	LOW		LOW		LOW	
Wash Temp	60 °C (140 °F)		60 °C (140 °F)		60 °C (140 °F)	
Rinse Temp	66 °C (150 °F)		66 °C (150 °F)		66 °C (150 °F)	
Cycle Slot #1	Wash Cycle	12	Wash Cycle	12	Wash Cycle	8
Cycle Slot #2	Purge Cycle	5	Purge Cycle	5	Purge Cycle	5
Cycle Slot #3	Rinse Cycle	5	Rinse Cycle	4	Rinse Cycle	4
Cycle Slot #4	Final Rinse Cycle	2	Final Rinse Cycle	2	Final Rinse Cycle	2
Cycle Slot #5	Dry Cycle	12	Dry Cycle	10	Dry Cycle	10
Cycle Slot #6	Idle Cycle	0	Idle Cycle	0	Idle Cycle	0
Cycle Slot #7	Idle Cycle	0	Idle Cycle	0	Idle Cycle	0
Cycle Slot #8	Idle Cycle	0	Idle Cycle	0	Idle Cycle	0
Cycle Slot #9	Idle Cycle	0	Idle Cycle	0	Idle Cycle	0
Cycle Slot #10	Idle Cycle	0	Idle Cycle	0	Idle Cycle	0
Rinse Resistivity	1500000.0 Ω ohms		1500000.0 Ω ohms		1500000.0 Ω ohms	
Final Rinse Resistivity	1500000.0 Ω ohms		1500000.0 Ω ohms		1500000.0 Ω ohms	
Wash Pressure	High		High		High	
Rinse Pressure	High		High		High	
Wash Flow	58		58		58	
Rinse Flow	58		58		58	
Final Rinse Flow	4.5		4.5		4.5	

General Cleaning

Introduction

Use these recipes for general cleaning, to define a new recipe for a unique application, or for test purposes before changing an existing recipe.

Table

The following table shows the default values for the predefined board cleaning recipes:

	General Clean #1		General clean #2		General Clean #3	
	Cycle/Value	Passes	Cycle/Value	Passes	Cycle/Value	Passes
Conv Speed	LOW		LOW		LOW	
Wash Temp	49 °C (120 °F)		49 °C (120 °F)		49 °C (120 °F)	
Rinse Temp	49 °C (120 °F)		49 °C (120 °F)		49 °C (120 °F)	
Cycle Slot #1	Wash Cycle	5	Wash Cycle	5	Wash Cycle	5
Cycle Slot #2	Purge Cycle	8	Purge Cycle	8	Purge Cycle	8
Cycle Slot #3	Rinse Cycle	4	Rinse Cycle	4	Rinse Cycle	4
Cycle Slot #4	Final Rinse Cycle	2	Final Rinse Cycle	2	Final Rinse Cycle	2
Cycle Slot #5	Dry Cycle	4	Dry Cycle	4	Dry Cycle	4
Cycle Slot #6	Idle Cycle	0	Idle Cycle	0	Idle Cycle	0
Cycle Slot #7	Idle Cycle	0	Idle Cycle	0	Idle Cycle	0
Cycle Slot #8	Idle Cycle	0	Idle Cycle	0	Idle Cycle	0
Cycle Slot #9	Idle Cycle	0	Idle Cycle	0	Idle Cycle	0
Cycle Slot #10	Idle Cycle	0	Idle Cycle	0	Idle Cycle	0
Rinse Resistivity	1500000.0 Ω ohms		1500000.0 Ω ohms		1500000.0 Ω ohms	
Final Rinse Resistivity	1500000.0 Ω ohms		1500000.0 Ω ohms		1500000.0 Ω ohms	
Wash Pressure	High		High		High	
Rinse Pressure	High		High		High	
Wash Flow	58		58		58	
Rinse Flow	58		58		58	
Final Rinse Flow	4.5		4.5		4.5	

Section B: Edit Recipes

Overview

Introduction Make adjustments to the predefined recipes as required using the following information.

In this section Refer to the following recipe editing steps:

Topic	See Page
Load Recipe Screen	6 – 94
System Screens	6 – 95
Edit Recipe	6 – 97

Load Recipe Screen

Introduction

The Load Recipe screen lists the predefined recipes available for cleaning. Refer to the Predefined Recipes on page 88 to review the operating parameters of the predefined recipes. If specific parameters for a recipe are not what is required for the process, choose the recipe that is closest to the requirements and make changes to adjust the parameters to fit the requirements.

Photograph

Figure 6–1 shows the Load Recipe screen.

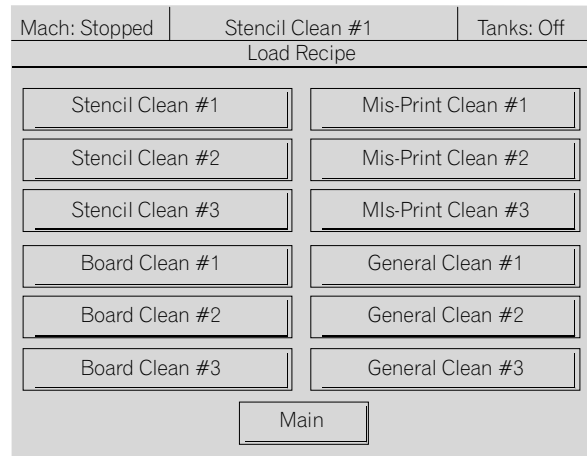

Figure 6–1

Procedure

Use the following steps to choose a predefined recipe:

1. Ensure the main power switch is in the On position.
2. Ensure chamber door is closed and latched.
3. Touch the Recipe button on the Main Screen to display the Load Recipe screen.
4. Touch the predefined recipe number for the specific process required.
5. Touch the Main button at the bottom to return to the Main Screen.

System Screens

Introduction

The System screens display the Configuration and Recipe Edit buttons, and the Thermocouple reference buttons.

Safety

To ensure personal safety and avoid equipment damage, observe the following:



ATTENTION

Actual thermocouple calibration is set at the factory. Access the Cal Wash, Rinse, and Chamber T/C thermocouple calibration screens from System Screen #2. These thermocouple calibration screens display the machine voltage at two (2) temperature readings. If any component replacements are required in the electrical panel, or a touch screen is replaced, the installing technician will re-calibrate the machine during installation.

Diagram

Figure 6–2 shows the first of the three (3) System Screens:

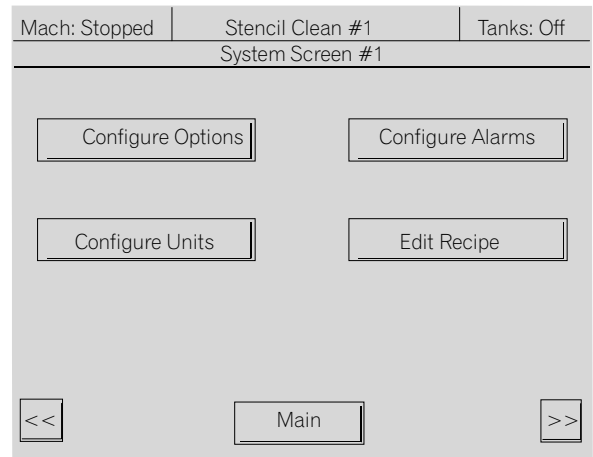

Figure 6–2

Diagram

Figure 6–3 and Figure 6–4 show the second and third System Screens:

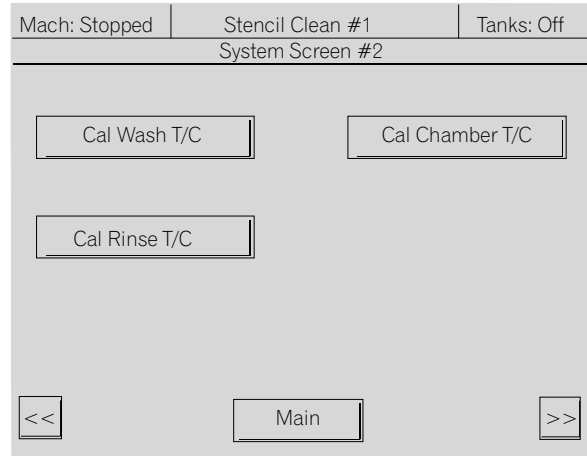

Figure 6–3

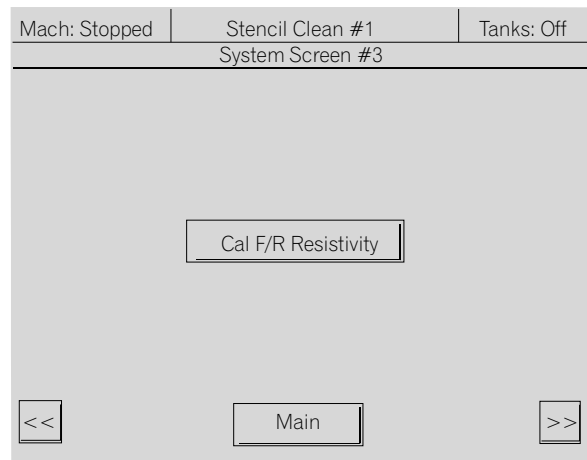

Figure 6–4

Procedure

Use the following steps to access the System Screens:

1. Ensure the main power switch is in the On position.
2. Ensure chamber door is closed and latched.
3. Touch the System button on the AquaJet™ Main screen.
4. Touch the recipe edit button to edit the currently selected recipe.
5. Touch the right double arrow button to display the second and third System screens.
6. Review the thermocouple temperature for the wash, rinse, or spray chamber as required and check the resistivity option calibration.
7. Touch the Main button at the bottom to return to the Main Screen.

Edit Recipe

Introduction

Define recipe parameters for specific process applications. As needed, refer to the Configuration Selections table below.

Safety

To ensure personal safety and avoid equipment damage, observe the following:



ATTENTION

When a cycle slot is not required, select Idle for the cycle definition and zero (0) for the number of passes.

Table

The following configuration selections table identifies the recipe parameters and provides an overview of the changes that can be made to each recipe parameter.

Component	Selection Choices	
	Cycle Definitions	Number of passes
Conveyor Speed	Low/High	
Wash Temperature	Degrees	
Rinse Temperature	Degrees	
Cycle Slot #1	Wash Rinse Dry Purge Final Rinse Idle	0-50
Cycle Slot #2		
Cycle Slot #3		
Cycle Slot #4		
Cycle Slot #5		
Cycle Slot #6		
Cycle Slot #7		
Cycle Slot #8		
Cycle Slot #9		
Cycle Slot #10		
Rinse Resistivity	M Ω ohms	
Final Rinse Resistivity	M Ω ohms	
Wash Pressure	Low/High	
Rinse Pressure	Low/High	
Wash Flow	Lpm (gpm)	
Rinse Flow	Lpm (gpm)	
Final Rinse Flow	Lpm (gpm)	

Diagrams

Figure 6–5 shows one (1) of the cycle process editing screens.

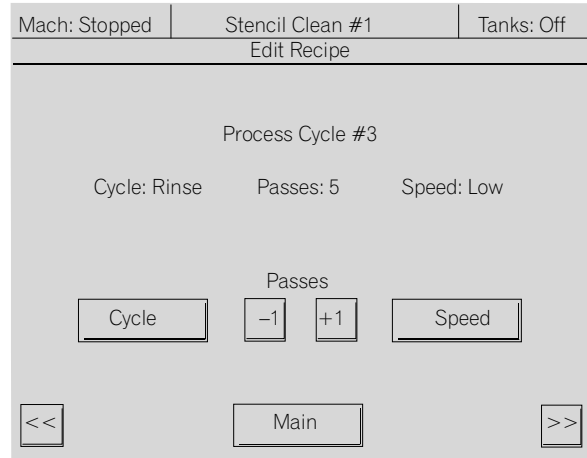

Figure 6–5

Procedure

To configure recipe cycle parameters:

1. Ensure the main power switch is in the On position.
2. Ensure chamber door is closed and latched.
3. Touch the System button on the AquaJet™ Main screen.
4. Touch the Edit Recipe button on the system screen. Process Cycle #1 screen displays.
5. Touch the Passes button to choose the number of times the cycle selected in Step 4. repeats. Range is 1 to 50 times. Touch the Speed button to set the carriage cycle speed to Low or High.
6. Touch the right double arrow button to display and configure the cycles in sequence.

Diagram

Figure 6–6 shows the temperature definition screen.

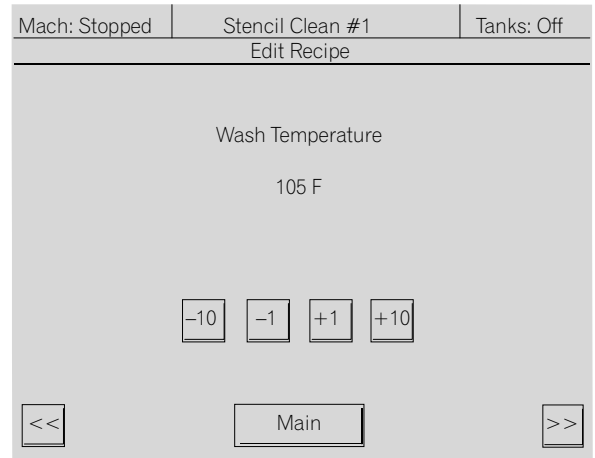

Figure 6–6

Procedure

Use the following information to set the Wash and Rinse temperature for the specific recipe:

1. Ensure the main power switch is in the On position.
2. Ensure chamber door is closed and latched.
3. Complete parameter definitions for all cycles.
4. After the last cycle is defined, touch the right double arrow button to display the wash temperature definition screen.
5. Touch the ± 1 or ± 10 buttons to increase or decrease the tank temperature for the current recipe definition. Range is from 0 to 155 °F.
6. Touch the right double arrow button to display the rinse temperature definition screen.
7. Repeat Step 5. for the rinse temperature.

Diagram

Figure 6–7 shows the wash pressure control screen.

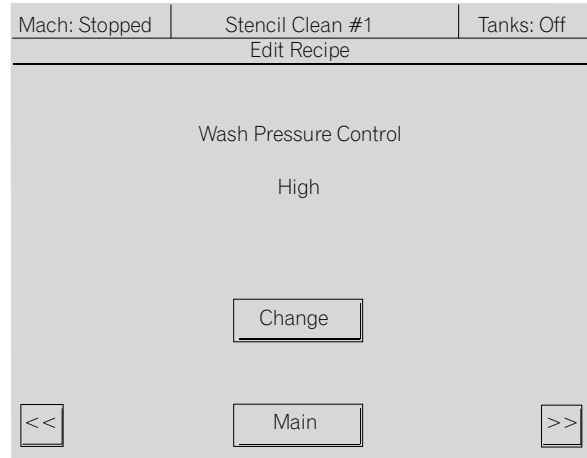

Figure 6–7

Procedure

Use the following information to set the wash and rinse pressure for the specific recipe:

1. Ensure the main power switch is in the On position.
2. Ensure chamber door is closed and latched.
3. Complete parameter definitions for all cycles and the wash and rinse temperatures.
4. Touch the right arrow button to display the wash pressure control definition screen.
5. Press the change button to toggle between high and low pressure.
6. Touch the right arrow button to display the rinse pressure control definition screen.
7. Repeat Step 5. to configure the rinse pressure control definition.

Diagram

Figure 6–8 shows the optional final rinse resistivity definition screen.

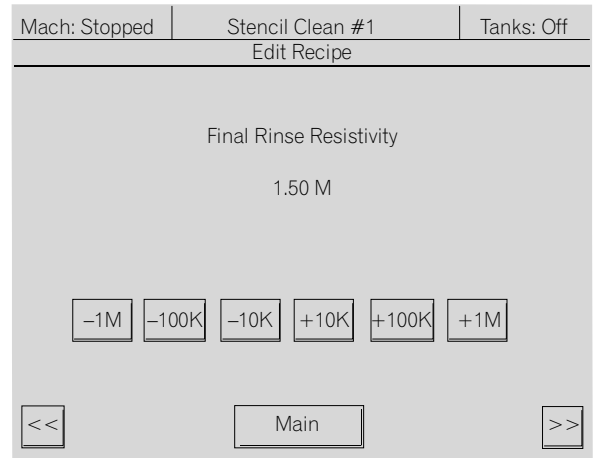

Figure 6–8

Procedure

Use the following information to set the optional resistivity for the final rinse:

1. Ensure the main power switch is in the On position.
2. Ensure chamber door is closed and latched.
3. Complete parameter definitions for all cycles, the wash and rinse temperatures and pressures.
4. Touch the right arrow button to display the final rinse resistivity definition screen.
5. Touch the $\pm 1M$, $\pm 100K$, or $\pm 10K$ buttons to increase or decrease the resistivity rate for the current recipe definition. Range is from 0 to 20 Meg Ohms.

Diagram

Figure 6–9 shows the wash flow rate screen.

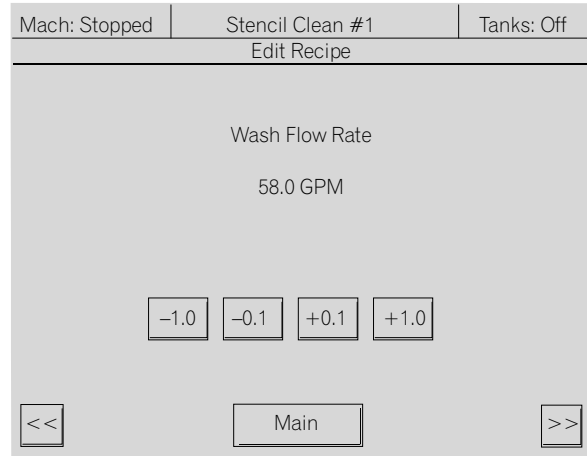

Figure 6–9

Procedure

Use the following information to set the flow rate for the specific recipe:

1. Ensure the main power switch is in the On position.
2. Ensure chamber door is closed and latched.
3. Complete parameter definitions for all cycles, the wash and rinse temperatures and pressures, and optional resistivity.
4. Touch the right arrow button to display the wash flow rate definition screen.
5. Touch the ± 1.0 or ± 0.1 buttons to increase or decrease the flow rate for the current recipe definition. Range is from 0 to 568 L/min. (0 to 150 gpm).
6. Touch the right arrow button to display the rinse flow rate definition screen.
7. Repeat Step 5. to configure the rinse flow rate definition.
8. Repeat the process to access and configure final rinse flow rate definition.

Section C: Recipes and Parameters

Overview

Introduction

The Tabular screens display the operating parameters of the currently selected recipe in tabular format. The Graphic screens display the operating parameters of the currently selected recipe using graphics.

In this section

Refer to the following recipe review sections:

Topic	See Page
Tabular Screens	6 – 104
Graphic Screens	6 – 105

Tabular Screens

Introduction

Ensure a recipe has been selected and loaded. The tabular screens display the parameters associated with the current recipe, set points, actual readings, and elapsed process time. The information displayed on the tabular screens duplicates the information displayed on the graphics screens.

Diagrams

Figure 6–10 shows main tabular process screen and Figure 6–11 shows the second tabular process screen.

Mach: Stopped		Stencil Clean #1		Tanks: Off
Tabular Process				
Recipe Parameter	Set Point	Actual		
Conveyor Speed		Off		
Passed: Wash	8	0		0:00
Passed: Airknife	2	0		0:00
Passed: Rinse	5	0		0:00
Passed: Final Rinse	2	0		0:00
Passed: Dry	5	0		0:00
Passed: Idle	0	0		0:00
Passed: Idle	0	0		0:00
Passed: Idle	0	0		0:00
Passed: Idle	0	0		0:00
Wash Temperature	150F	32F	===	
Rinse Temperature	150F	32F		0:00

<< Main >>

Figure 6–10

Mach: Stopped		Stencil Clean #1		Tanks: Off
Tabular Process				
Recipe Parameter	Set Point	Actual		
Chamber Temperature		9 F		
Wash Pressure Ctrl	High			
Rinse Pressure Ctrl	High			
F/R Resistivity	1.50 M	-5.42 M		
Wash Flow	55.0 GPM	0.0 GPM		
Rinse Flow	55.0 GPM	0.0 GPM		
Final Rinse Flow	3.5 GPM	0.0 GPM		

<< Main >>

Figure 6–11

Procedure

Use the following steps to view recipe parameters:

1. Ensure the main power switch is in the On position.
2. Ensure chamber door is closed and latched.
3. Touch the Tabular button to display the first Tabular Process screen.
4. Touch the right or left double arrow button to display the second Tabular screen.
5. After viewing the parameters, touch the Main button at the bottom to return to the Main Screen.

Graphic Screens

Introduction

Ensure a recipe has been selected and loaded. The graphics button graphically displays individual cycle processes as they occur and lists parameters associated with the current recipe. The right and left arrow buttons at the bottom of the screen allow the operator to sequence through or review previous cycles. The information displayed on the graphic screens duplicates the information displayed on the Tabular screens.

Diagram

Figure 6–12 shows the Wash Cycle graphics screen.

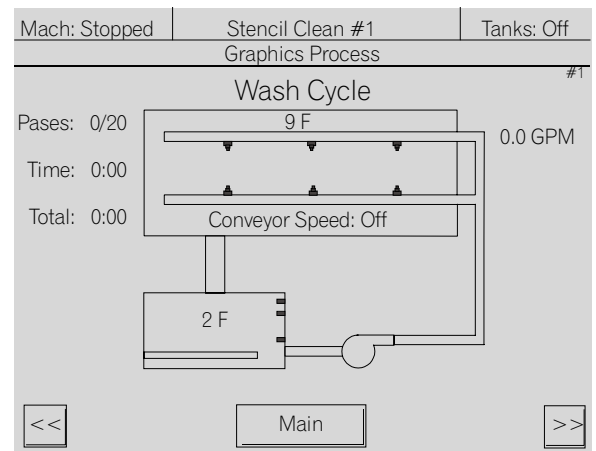

Figure 6–12

Reference

Use the following to identify the recipe parameters for each graphics screen:

1. Touch the graphics button on the AquaJet™ Main screen to access the individual cycle graphic screens. For reference, the cycle number displays in the upper right of the screen.
 - The upper rectangle graphically represents the spray chamber. The number at the top indicates the ambient chamber temperature. In the lower section of the rectangle the recipe defined conveyor speed displays.
 - The lower rectangle represents the reservoir tank. The number indicates reservoir tank temperature. The small blocks on the right of the reservoir tank indicate the tank liquid level.
 - The Pases numbers indicate the predefined number of passes for the cycle and how many passes have finished processing.
 - The Time indicates the amount of time that has elapsed for this cycle.
 - The Total number indicates the total amount of time that has elapsed in the current recipe.
 - The gpm number indicates the recipe defined flow rate for the specific cycle.
2. After viewing the parameters, touch the Main button at the bottom to return to the Main Screen.

Procedure

Use the following steps to access the graphics screens:

1. Ensure the main power switch is in the On position.
2. Ensure chamber door is closed and latched.
3. Touch the Graphics button on the AquaJet™ Main screen.
4. The first defined cycle graphic for the chosen recipe displays.
5. Touch the right or left double arrow button to display subsequent or previous cycle screens as defined by the active recipe.
6. Touch the Main button at the bottom to return to the Main screen.

Diagram

Figure 6–13 shows the Purge Cycle graphics screen.

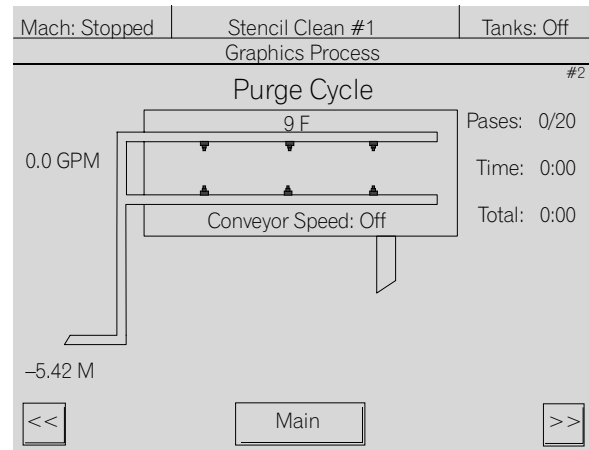

Figure 6–13

Diagrams

Figure 6–14 through Figure 6–16 show the Rinse Cycle, Final Rinse Cycle, and Dry Cycle Graphics screens respectively.

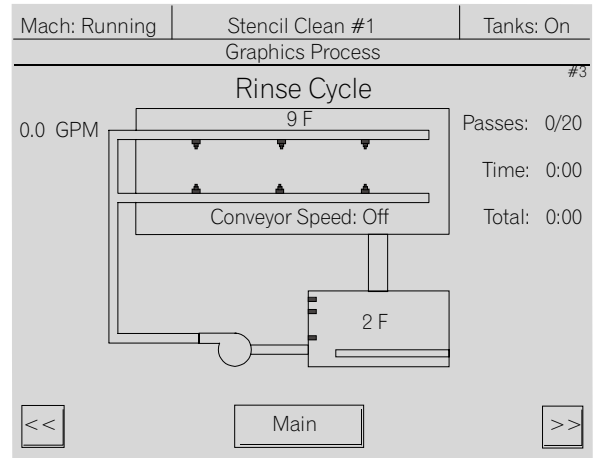

Figure 6–14

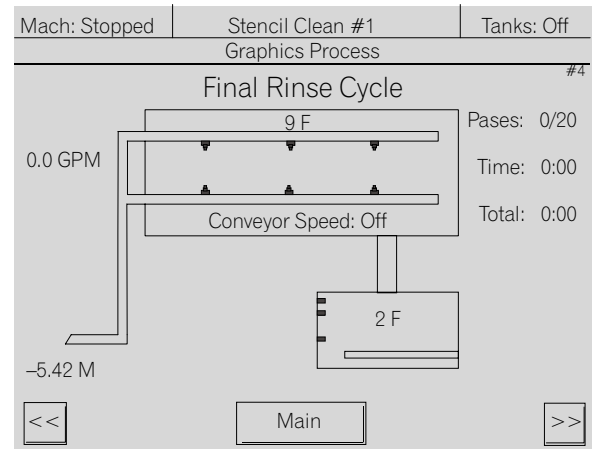

Figure 6–15

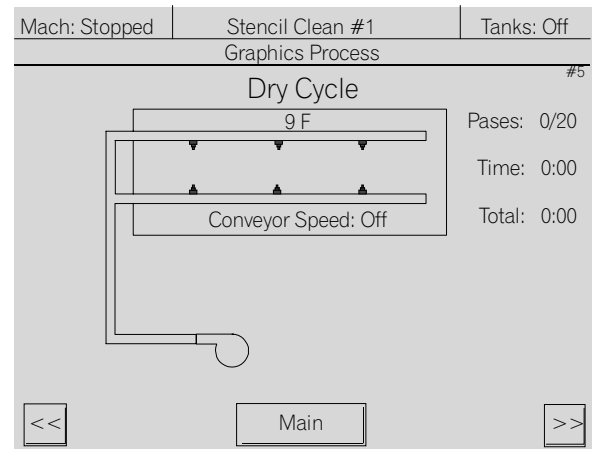

Figure 6–16

Diagram

Figure 6–17 shows the Idle Cycle Graphics Screen.

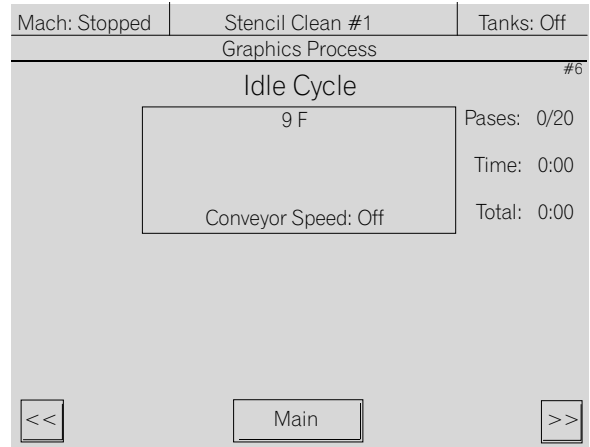

Figure 6–17

Troubleshooting

Overview

Introduction

This section lists possible operation and process problem scenarios the operator may encounter during AquaJet™ operation.

In this chapter

This chapter consists of the following:

Topic	Section
Operation Troubleshooting	A
Process Troubleshooting	B

Section A: Operation Troubleshooting

Problem Cause and Recovery

Introduction

Problems can be encountered during product processing. This section recommends operator actions to evaluate and/or correct the problem. Refer to other AquaJet™ Guides within the Information Set for detailed information as required.

Table

Refer to the following operation troubleshooting chart to locate an operation problem and find a possible solution:

Symptom	Probable Cause	Recovery
No heat in wash or rinse tank	Immersion heater burned out	Replace immersion heater.
	Temperature set point set too low	Adjust temperature to correct setting.
	Thermocouple is defective	Replace thermocouple.
	Fuse is blown	Replace fuse.
	Immersion heater contactor defective	Replace immersion heater contactor.
	Low level float switch deactivates immersion heaters	Contact Technical Support.
Low level alarms	Scale buildup on heaters reduces heat output	Perform descaling procedure.
	Make up level float switch sticks	Clean or replace float switch.
	Low level float switch sticks	Clean or replace float switch.
	Scale build up on or around float switches	Perform descaling procedure.
High level alarms	Drain solenoid stuck in open position	Perform Lock Out-Tag Out steps (See Lock-Out Tag-Out on page 10.) and clean or replace the solenoid.
	Drain solenoid defective	Perform Lock Out-Tag Out steps (See Lock-Out Tag-Out on page 10.) and clean or replace the solenoid.
	Clogged drain	Perform maintenance procedure on tank where drain is located.
	High level float switch stuck	Clean or replace float switch.

Symptom	Probable Cause	Recovery
Jerky conveyor	Chain slipping or loose	Adjust main chain tensioner under top access doors. Adjust motor bracket at rear of machine.
	Conveyor speed control out of calibration	Refer to the calibration section in the Preventive Maintenance Guide.
Wash or rinse water does not activate	Defective solenoid	Replace the solenoid.
	Broken or loose wire connection.	Perform Lock Out-Tag Out steps (See Lock-Out Tag-Out on page 10.) and repair the wire.
	Facility water supply diminished or not activated	Replenish or activate facility heated water supply.
Immersion heater over-temperature sensor does not reset	Immersion heater and/or over-temperature sensor need replacement	Contact Technical Support for assistance in the replacement process.

Section B: Process Troubleshooting

Process Information

Introduction

This section lists possible process problem scenarios the operator may encounter during AquaJet™ operation.

Table

Use one of the following actions to check and/or correct the problem.

Process	Reference
Water Temperature	The most important factor for obtaining clean product under most conditions is water temperature. Ensure water temperature is maintained between 60–71 °C (140–160 °F) to assure the cleanest PCB assemblies possible.
Water Cleanliness	The cleaner the water introduced into a PCB assembly within any aqueous cleaning process, the lower the contaminant level. It is recommended that the operator or quality inspector verify water quality at predetermined intervals.
Water Pressure	The amount of water pressure applied to product being cleaned determines the amount of residue and other contaminant removal accomplished. Adequate pressure helps ensure contaminants entrapped under components are removed without damage to the assembly.
Component Temperature	The temperature of the product and its components as it enters the AquaJet™ system is important to the cleaning process. It is best to clean product with heated water while it is still hot from previous processing.
Dryer Temperature	Precise control of blower dryer air temperature enhances the ability to dry components on most product configurations.

Preventive Maintenance

Overview

Introduction

A strong preventive maintenance program is the best method to cut costs, increase system reliability, and enhance productivity. The time used for cleaning, inspecting, and servicing ensures consistent production quality and increases the extended service life of the machine.

The preventive maintenance tables are designed to enhance, not replace, any internal preventive maintenance schedules. To assist implementation, the tables are divided into separate time intervals. The time intervals assume single shift operation. If multiple shifts occur, adjust the time intervals as necessary for effective operation.

In this chapter

This chapter consists of the following information:

Topic	Section
Safety Information	A
Maintenance Screens	B
Maintenance Tables	C

Section A: Safety Information

Reference Information

Introduction

Operation of this equipment exposes personnel to potential health hazards. Detailed information on safety hazards, precautions, and Lock Out-Tag Out procedures is provided in Section 1 of this guide.

Safety

To ensure personal safety and avoid equipment damage observe the following:



CAUTION

Qualified technical maintenance staff should perform all preventive maintenance steps. If any damage to any component is noted, contact Electrovert Customer Service.



CAUTION

Failure to perform and document preventive maintenance procedures may void machine warranty.



ATTENTION

Perform the preventive maintenance procedures in the sequence presented. Failure to follow described procedures may result in personal injury or damage to the equipment.

Section B: Maintenance Screens

Maintenance Overview

Introduction

The Maintenance touch button accesses three (3) maintenance screens. The operator turns various system functions On and Off as required for maintenance purposes. These steps are used during preventive maintenance procedures and to test specific items before returning to normal system operation. Refer to the AquaJet™ Preventive Maintenance Guide for detailed maintenance procedures.

Diagrams

Figure 8–1 shows maintenance screen #1 and Figure 8–2 shows maintenance screen #2.

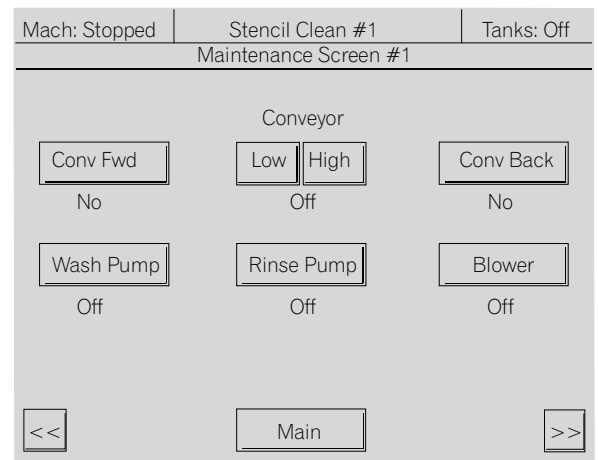

Figure 8–1

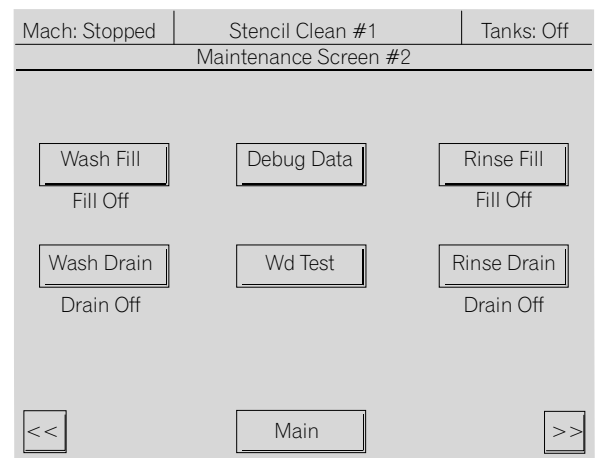

Figure 8–2

Diagram

Figure 8–3 shows maintenance screen #3.

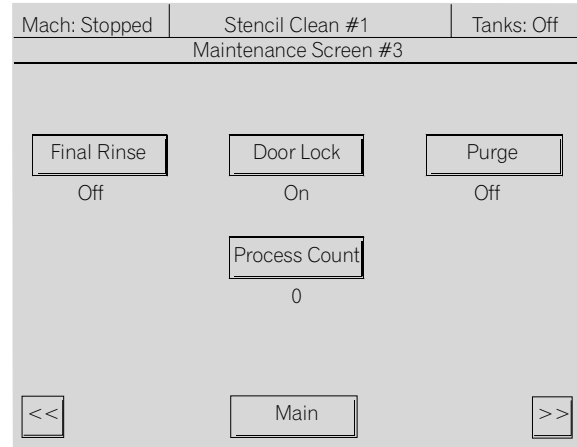

Figure 8–3

Procedure

The operator can manually control the conveyor, pumps, blower, and reservoir tank fill or empty cycle during the maintenance process. Refer to the AquaJet™ Preventive Maintenance Guide for detailed maintenance procedures.

Use the following steps to adjust conveyor position:

1. Ensure the main power switch is in the On position.
2. Ensure chamber door is closed and latched.
3. Touch the Maintenance button on the AquaJet™ Main screen.
4. Touch the Conv Fwd or Conv Back button on Maintenance Screen #1 to move the Conveyor to the front, Home Position, or rear of the machine.
5. Touch the Low or High button to run the conveyor speed.
6. Touch the Main button at the bottom to return to the Main screen.

Procedure

Use the following steps to check pumps and blower:

1. Ensure the main power switch is in the On position.
2. Ensure chamber door is closed and latched.
3. Touch the Maintenance button on the AquaJet™ Main screen.
4. Touch the Wash Pump, Rinse Pump, or Blower button on Maintenance Screen #1 to turn the specific pump/blower On or Off.
5. Touch the Main button at the bottom to return to the Main screen.

Procedure

Use the following steps to start manual fill/drain:

1. Ensure the main power switch is in the On position.
2. Touch the Maintenance button on the AquaJet™ Main screen.
3. Touch the right double arrow button to display Maintenance Screen #2.
4. Touch the Wash Fill or Rinse Fill button to toggle between Fill On and Fill Off positions.
5. Touch the Main button at the bottom to return to the Main screen.

Section C: Maintenance Tables

Preventive Maintenance

Introduction

A strong preventive maintenance program is the best method to cut costs, increase system reliability, and enhance productivity. The time used for cleaning, inspecting, and servicing ensures consistent production quality and increases the extended service life of the machine.

The operator is responsible to keep the work area clean and free of debris and ensure all inspected items are ready for operation.

Safety

To ensure personal safety and avoid equipment damage observe the following:



CAUTION

Qualified maintenance staff should perform preventive maintenance or repair of items. If any damage to any of the inspected items is detected, contact the company preventive maintenance staff or Electrovert Customer Service.

In this section

Refer to the following information:

Topic	Section
Daily Operator Maintenance	8 – 118
Daily Technician Maintenance	8 – 119
Monthly Technician Maintenance	8 – 120
Semi-Annual Technician Maintenance	8 – 121
Annual Technician Maintenance	8 – 122

Tools and materials

Use the following materials for cleaning:

- White, lint-free cloth
- All purpose ammonia based cleaner
- Shop vacuum
- Clean facility compressed air
- Clean facility hose connected to the facility water source
- Deionized (DI) water if used in processing

Daily Operator Maintenance

Introduction

The following operator maintenance schedule is provided as a guideline. Modify it as necessary to meet the specific production process. As required, make copies and distribute to operators for permanent preventive maintenance record keeping purposes.

Daily preventive maintenance should be performed after every eight (8) hours of machine operation.

Daily Schedule

Refer to the following maintenance schedule to ensure proper machine operation.

Daily Operator Maintenance — Every eight (8) hours of Operation			
Procedure	Reference		
		Initials	Date
Wipe spills around the system perimeter.			
Clean all system exterior surfaces.			
Clean front door and inspect seals.			
Clean proximity switch.			

Comments:

Daily Technician Maintenance

Introduction

The following technician maintenance schedule is provided as a guideline. Modify it as necessary to meet the specific production process. As required, make copies and distribute to maintenance personnel for permanent maintenance record keeping purposes.

Daily preventive maintenance should be performed after every eight (8) hours of machine operation.

Daily Schedule

Refer to the following maintenance schedule to ensure proper machine operation.

Daily Technician Maintenance — Every eight (8) hours of Operation			
Procedure	Reference		
		Initials	Date
Adjust proximity switch if necessary.			
Inspect carriage assembly movement to ensure smooth and straight operation, recalibrate as required.			
Inspect and wipe down spray nozzles, clean if necessary.			
Thoroughly rinse all wet sections.			
Drain and rinse all system tanks.			
Inspect and clean all tank catch baskets.			
Inspect and clean all system drain screens.			
Inspect float switch mechanisms for damage or restriction and replace if necessary.			
Inspect and clean pump recirculation filters in all system tanks, replace if necessary.			

Comments:

Monthly Technician Maintenance

Introduction

The following technician maintenance schedule is provided as a guideline. Modify it as necessary to meet the specific production process. As required, make copies and distribute to maintenance personnel for permanent maintenance record keeping purposes.

Monthly preventive maintenance should be performed after every 160 hours of machine operation.

Monthly Schedule

Refer to the following maintenance schedule to ensure proper machine operation.

Date: _____			
Monthly Technician Maintenance — Every 160 hours of Operation			
Procedure	Reference		
	Initials	Date	
Perform all daily maintenance procedures.			
Ensure external exhaust venting joint is secure.			
Inspect all plumbing clamp connections for leaks and repair/replace as necessary.			
Descale all wet sections as required.			
Check chamber air hoses and connectors for wear and replace if necessary.			
Check chamber water hoses and connectors for wear and replace if necessary.			
Inspect all wet spray nozzles and spray bars for scale build up and descale as required.			
Inspect all tanks, immersion heaters, and float switches for scale build up, descale as required.			
Inspect blower belts for wear and replace as required.			
Inspect and clean/replace blower air filters.			

Comments:

Semi-Annual Technician Maintenance

Introduction

The following technician maintenance schedule is provided as a guideline. Modify it as necessary to meet the specific production process. As required, make copies and distribute to maintenance personnel for permanent maintenance record keeping purposes.

Semi-Annual preventive maintenance should be performed after every 780 hours of machine operation.

Semi-Annual Schedule

Refer to the following maintenance schedule to ensure proper machine operation:

Date: _____			
Semi-Annual Technician Maintenance — Every 780 hours of Operation			
Procedure	Reference		
		Initials	Date
Perform all daily maintenance procedures.			
Perform all monthly maintenance procedures.			
Inspect tank immersion heaters for damage and replace if necessary.			
Inspect and clean electric panel air filter and replace if necessary.			
Lubricate carriage motor grease fittings and bearings.			
Lubricate carriage drive chain.			
Lubricate blower motor grease fittings and bearings.			

Comments:

Annual Technician Maintenance

Introduction

The following technician maintenance schedule is provided as a guideline. Modify it as necessary to meet the specific production process. As required, make copies and distribute to maintenance personnel for permanent maintenance record keeping purposes.

Annual preventive maintenance should be performed after every 1560 hours of machine operation.

Annual Schedule

Refer to the following maintenance schedule to ensure proper machine operation.

Date: _____			
Annual Technician Maintenance — Every 1560 hours of Operation			
Procedure	Reference		
	Initials	Date	
Perform all daily maintenance procedures.			
Perform all monthly maintenance procedures.			
Perform all semi-annual maintenance procedures.			
Clean low and high voltage panels and replace panel air filters.			
Inspect all wiring connections and tighten as required.			
Inspect fuse blocks for signs of discoloration and replace if necessary.			
Inspect contactors for pitting or wear, replace if necessary.			
Inspect pressure gauge lines for damage and secure connections, replace if necessary.			

Comments:

Error Messages

Overview

Introduction

This chapter describes the process of responding to error messages that may display.

In this chapter

This chapter consists of the following:

Topic	Section
Process Error Messages	A
Process Alarms	B

Section A: Process Error Messages

Error Message List

Introduction

Normal machine operation should proceed without problems. When problems develop, error messages display on the menu title line of the LCD display screen.

Safety

To ensure personal safety and avoid equipment damage, observe the following:



ATTENTION

Some corrective actions require preventive maintenance or repair procedures. Refer to the AquaJet™ Preventive Maintenance Guide or AquaJet™ Repair Guide for detailed information.

Table

The following table lists the error messages an operator might receive during system operation and suggests corrective actions to take.

Error Message	Corrective Action
Emergency Stop Pressed	<ul style="list-style-type: none"> Identify the reason the E-Stop button was pressed Correct the problem Pull the E-Stop button out
Loading Door Open	<ul style="list-style-type: none"> Close and latch loading door
Conveyor Fault	<ul style="list-style-type: none"> Check the conveyor chain drive for problems Check the conveyor motor operation Check the home position proximity switch
Machine is Running	<ul style="list-style-type: none"> Action chosen cannot be performed during machine operation Allow the machine to complete the process, then chose the requested action
Wash Tank Low Level Rinse Tank Low Level	<ul style="list-style-type: none"> Stop the current process Add water to the wash or rinse tank Verify drains are not turned On Check tank for float switch damage, replace if necessary
Wash Tank High Level Rinse Tank High Level Sump #1 Tank High Level Sump #2 Tank High Level	<ul style="list-style-type: none"> Stop the current process Drain water from the wash or rinse tank Check tank for float switch damage, replace if necessary Verify the pneumatic seals are functioning properly, replace if necessary
Wash Temperature Out of Tolerance Rinse Temperature Out of Tolerance	<ul style="list-style-type: none"> Check wash or rinse temperature set point Check wash or rinse temperature deviation amount Check immersion heaters, replace if necessary

Error Message	Corrective Action
Machine High Temperature	<ul style="list-style-type: none"> • Stop machine cycle • Check blower motor operation • Check blower motor air filter, replace if necessary • Check immersion heaters, replace if necessary
Wash Flow Out of Tolerance Rinse Flow Out of Tolerance Final Rinse Flow Out of Tolerance	<ul style="list-style-type: none"> • Check wash, rinse, or final rinse inlet water supply • Check optional flow meters
Wash Pressure Out of Tolerance Rinse Pressure Out of Tolerance Final Rinse Pressure Out of Tolerance	<ul style="list-style-type: none"> • Check pressure gauges • Check Vee Jets™ and optional Hurricane Jet™ or Delta nozzles for debris, clean if necessary • Check wash, rinse pump operation
Rinse Resistivity Too Low Final Rinse Resistivity Too Low	<ul style="list-style-type: none"> • Check optional resistivity meter • Check rinse tank resistivity probe • Check final rinse inlet plumbing resistivity probe
End of Process Cycle	<ul style="list-style-type: none"> • Information message when recipe cycle completes
Draining Wash From Chamber Draining Rinse From Chamber Draining Final Rinse From Chamber Draining Purge From Chamber	<ul style="list-style-type: none"> • Action chosen cannot be performed during drain process • Allow the machine to complete draining, then chose the requested action
Final Rinse Is On Wash Pump Is On Rinse Pump Is On Blower Is On	<ul style="list-style-type: none"> • Action chosen cannot be performed when Final Rinse, Wash or Rinse pump, or Dryer Blower is turned On
Purging Chamber	<ul style="list-style-type: none"> • Action chosen cannot be performed during purge cycle
Tanks Must Be Off	<ul style="list-style-type: none"> • Action chosen cannot be performed when tanks are On

Section B: Process Alarms

Process Alarms

Introduction

The audible alarm sounds on the initial occurrence of a configured alarm until the touch screen is touched. The Alarms button on the AquaJet™ Main Screen displays active alarms and their status. The operator reviews active and cleared alarms using this screen.

Diagrams

Figure 9–1 shows the main screen with an active alarm message.

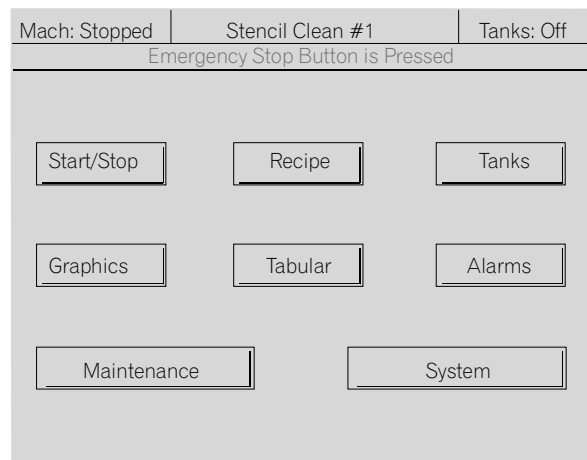

Figure 9–1

Procedure

When an alarm occurs:

- Alarm message briefly displays on the LCD in place of the screen title text
 - Audible alarm sounds
 - If alarm is configured as HardStop, the system shuts down operation
-

Procedure

Use the following steps to respond to an active alarm:

1. Touch the screen to stop the alarm sound.
 2. Ensure the main power switch is in the On position.
 3. Ensure chamber door is closed and latched.
 4. Touch the Alarms button on the AquaJet™ Main screen.
 5. Alarms with Alm – to the left of the alarm description are active and must be corrected.
 6. Check the alarm description and correct the alarm situation.
 7. Clear the alarm.
-

Diagram

Figure 9–2 shows the alarms screen where the operator completes the alarm response process.

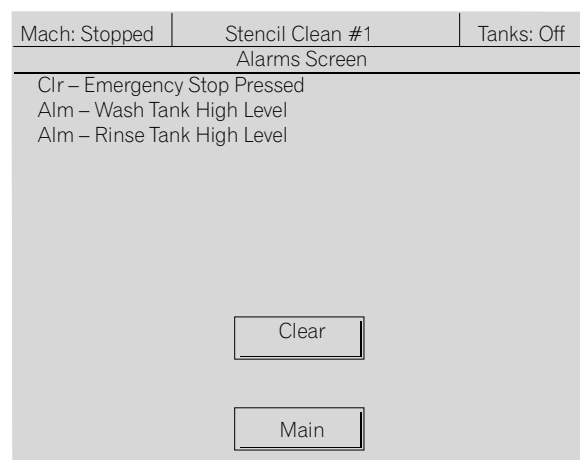

Figure 9–2

Procedure

Use the following steps to clear an alarm after responding to and correcting the alarm situation:

1. Ensure the main power switch is in the On position.
2. Ensure chamber door is closed and latched.
3. Touch the Alarms button on the AquaJet™ Main screen.
4. After responding to and correcting an alarm condition, Clr – displays to the left of the alarm description.
5. Press the Clear button.
6. All alarms with Clr – to the left of the alarm description disappear from the display.
7. Touch the Main button at the bottom to return to the Main screen.
8. When restarting the system after clearing a HardStop alarm condition turn the main power switch to the On position and ensure the E-Stop button is pulled out.
9. If power is activated and an alarm condition remains active, the alarm re-occurs. Correct the alarm and resume system operation.

Glossary

Overview

Introduction

This chapter lists industry terms as they relate to printed circuit assembly cleaning. Many of the definitions are from the IPC (Institute For Interconnecting And Packaging Electronic Circuits) web site (www.ipc.org).

In this chapter

This chapter consists of the following:

Topic	Section
Cleaning Industry Terms	A

Section A: Cleaning Industry Terms

Electronics Cleaning Terms and Definitions

ACID A substance that ionizes in solution to release the positive ion of the solute. The strength of the acid is proportionate to the amount of ions released in solution. The strongest acids have the lowest pH readings, i.e. closest to 1.0.

ACIDITY The quantitative capacity of a water or water solution to neutralize an alkali or base. It is usually measured by titration with a standard solution of sodium hydroxide and expressed in terms of its calcium carbonate equivalent.

AERATION The process in which air is brought into intimate contact with water, often by spraying water through air or by bubbling air through water. Aeration may be used to add oxygen to the water for the oxidation of matter such as iron, or to cause the release of dissolved gasses such as carbon dioxide or hydrogen sulfide from the water.

AIRKNIFE A means, usually a slotted tube, by which air can be directed into a focused flow toward a surface. Airknife shapes and orifices can vary. The term air knife can also refer to the curtain or "knife" of air itself. Typically airknives are fed by high velocity or high volume blowers.

ALKALINITY The quantitative capacity of a water or water solution to neutralize an acid. It is usually measured by titration with a standard acid solution of sulfuric acid and expressed in terms of its calcium carbonate equivalent.

ANION A negatively charged ion that migrates to an anode, as in electrolysis.

ANION EXCHANGE An ion exchange process in which anions in solution are exchanged for other anions from an ion exchanger.

BASE A substance that ionizes in solution with water to release negatively charged hydroxyl (OH₋) ions. The strength of the base is proportionate to the amount of hydroxyl ions released in solution. The strongest bases have the highest pH readings, i.e. closest to 14.0. (Base is also referred to as alkali or alkaline).

BED The ion exchanger or filter media in a column or other tank or operational vessel.

BIODEGRADABILITY	The propensity of a substance to decompose by microorganisms normally found in the environment.
B.O.D/C.O.D.	Biological oxygen demand/chemical oxygen demand. A relative measure of impact, in terms of oxygen demand, of dissolved and colloidal organic matter oil the biological units (bacteria) required to maintain a properly functioning waste treatment facility. Chemical additives to aqueous cleaning systems will often raise BOD/COD over the acceptable limits of the POIV.
BRACKISH WATER	Water containing dissolved solids in the range of 1,000 to 10,000 mg/l.
BRINE	A strong solution of salt(s), such as the sodium chloride brine used in the regeneration of ion exchange water softeners, but also applies to the mixed sodium, calcium, and magnesium chloride waste solution from regeneration.
CFC	Abbreviation for Chlorofluorocarbon.
CAPACITY	An expression of the quantity of an undesirable material which can be removed by a water conditioner between servicing of the media, i.e., cleaning, regeneration, or replacement, as determined under standard test conditions.
CAPILLARY ACTION	The interaction between a liquid and a small diameter opening in a solid. Because of surface tension, the liquid is drawn into tile opening by this action. The Young-Laplace equation of differential pressure can demonstrate this phenomenon.
CATION	A positively charged ion that migrates to a cathode during electrolysis.
CATION EXCHANGE	Ion exchange process in which cations in solution are exchanged for other cations from an ion exchanger.
CHEMICAL ISOIATION	Term developed by Hollis Automation referring to an enhanced drag-out section in an in-line cleaner. Instead of a simple airknife/blower combination, chemical isolation uses a low-flow water spray in between two sets of airknives to flush residual wash water from connector bodies, under components, etc. The water from this section may be supplied from the rinse section, from its own tank, or from an external source.

**CHEMICAL
COMPATIBILITY**

This term refers to the acceptability of use of a chemical relative to the machine in which it's used, and tile product it cleans. Some chemistries will have degradable effects on equipment and/or boards. Chemical compatibility should be verified prior to implementing a cleaning process.

**CHLORINATED
POLYVINYL (CPVC)**

A plastic often used in cleaner plumbing which is similar to commercially available PVC found in domestic plumbing, however, it can handle greater temperatures and pressures. It is available in Schedule 40 or Schedule 80 grades, with 80 being the most durable. CPVC plumbing is easy to work with because it does not require threading or welding, it is glued. CPVC also works well with Deionized water.

**CLEANLINESS
TESTING**

Any of a family of tests used to verify a required cleanliness specification. Testing may include residual ionic evaluation (conductivity testing), surface insulation resistance testing (SIR), chromatography evaluation.

CONCENTRATE

Waste water which is sent to the drain from a reverse osmosis (RO) machine.

CONDENSATION

The change of state from a gas to a liquid.

CONDUCTIVITY

The quality or power to carry electrical current. In water, conductivity is related to the concentration of ions capable of carrying electrical current.

**CONDUCTIVITY
TESTING**

Also known as residual ionic evaluation, solvent extract resistivity testing and Omegameter/Ionograph testing. A quantitative evaluation of residual conductive (ionic) material left on a board in which this material is expressed as an equivalent of micrograms of salt (NaCl) per square inch. This test involves immersing the board in a known volume of solution of isopropyl alcohol and deionized water at a known initial conductivity. In some machines this solution is heated and agitated during the test period. During the typical 10 minute test, residual ionics go into solution, thus increasing the conductivity of the solution. By analyzing this change in conductivity relative to the surface area of tile board, an equivalent measurement of contamination can be determined. There are many specifications covering this test, but the most quoted is Mil-P-28809.

CONTAMINANT

An impurity that may or may not affect the performance of a circuit assembly. Typically, contaminants are classified as polar, non-polar or particulate in nature.

CONTAMINATION

The addition of foreign matter to a substance which reduces the value of the substance, or interferes with its intended use.

CORROSION	The destructive disintegration of metal by electrochemical means.
DEFOAMING AGENT	An additive to wash or rinse tanks in a cleaner which will reduce the tendency to produce a head of foam in the tank.
DEIONIZATION (DI)	The removal of all ionized minerals and salts (both organic and inorganic) from a solution by a two-phase ion exchange procedure. The term is often used interchangeably with demineralization.
DEIONIZED WATER	Water which has had a degree of positive and negative ions removed so as to decrease its conductivity (raise resistivity). Typically, this is done in the ion exchange process. In general, the highest degree of deionization possible under normal conditions will result in resistivity of 18.2 meg-ohms. Tap water has resistivity as low as 1-5 kilo-ohms. In addition to having low conductivity potential, DI water is prone to absorbing ions aggressively in the rinse process. Because of low dissolved mineral content, DI water is also less prone to leaving water spots on a board. In the cleaning process, it is rarely necessary to deionize to the 18.2 meg-ohm extent. Desired results can usually be achieved in the 500k to 3 meg-ohm range.
DETERGENT	A cleaning agent that exerts an emulsifying action at polar/non-polar interfaces, as in oil/water, so as to separate them and enable them to be rinsed away.
DISSOLVED SOLIDS	The weight of matter in true solution in a stated volume of water; includes both inorganic and organic matter; usually determined by weighing the residue after evaporation of the water at (105° or 180° C) (221° or 356° F).
DRAG-OUT	The carryover of water, wash chemistry, and/or contaminants in solution from one functional section of a cleaner to another.
EFFLUENT	The stream emerging from a unit, system, or process, such as the softened water from an ion exchange softener or run-off to a drain.
EVAPORATION	The process by which a liquid vaporizes into the surrounding atmosphere. This process can generally be accelerated by adding heat. One cause of the loss of water in a cleaning system is evaporation.
FEED WATER	Any water fed into a machine.

FINAL RINSE	The last wet section of a cleaner. Typically, this is where deionized water is introduced to the machine. It may or may not cascade to preceding sections.
FILTER	A device or system for the removal of solid particles (suspended solids); includes mechanical, adsorptive, oxidizing, and neutralizing filters.
FILTRATION	The process of separating suspended solids from a liquid by forcing the mixture through a porous barrier.
GRAIN (gr.)	A unit of weight equivalent to 0.0648 gram or 1/70000 of a pound.
GRAIN PER GALLON (gpg)	A common basis for reporting water analyses in the United States and Canada; one grain per US gallon equals 17.12 milligrams per liter (mg/L). One grain per British (Imperial) gallon equals 14.3 milligrams per liter or parts per million.
HARDNESS	A characteristic of natural water due to the presence of dissolved calcium and magnesium; water hardness is responsible for most scale formation in pipes and water heaters. Hardness is usually expressed in grains per gallon, parts per million, or milligrams per liter.
HARD WATER	Water containing a total hardness of one grain per gallon or more of calcium carbonate or other minerals which tend to collect on cleaner tank walls and in plumbing, forming a hard-to-remove scum layer.
HYDRATION	The chemical combination of water into a substance.
INFLUENT	The stream entering a unit, system, or process, such as the water entering the prewash, wash, chemical isolation, rinse, or final rinse sections of an aqueous cleaner or the hard water entering an ion exchange water softener.
INORGANIC	A chemical compound not having the element carbon, with the exception of carbon dioxide and compounds containing the carbonate radical.
ION	A positively or negatively charged particle. Ionic residues are conductive.

ION EXCHANGE	A reversible process using coated resins called anionic and cationic in which ions are released from an insoluble permanent material in exchange for other ions in a surrounding solution. The direction of the exchange depends upon the affinities of the ion exchange for the ions present and the concentration of the ions in the solution. Typically, this process is combined with a carbon tank to remove organic contaminants and a bag or cartridge filter to remove large particulates. This process is used to deionize water.
IONIC CONTAMINATION	Residual material left on a board that is ionic in nature, and, therefore, is potentially conductive.
MEDIA	The selected materials in a filter that form the barrier to the passage of certain suspended solids or dissolved molecules.
MICRON	A linear measure equal to one millionth of a meter, or 0.00003937 inch. The symbol for the micron is the Greek letter μ .
NO-CLEAN FLUX	A low residue flux that can be left on the substrate. As components become more complex, very weak flux that leaves a small residue becomes a problem.
NON-POLAR	A substance that will not breakdown electrically into positive and negative components in solution. A non-polar contaminant can only be removed by a non-polar solvent. Rosin is a non-polar contaminant.
ODP	Ozone-depleting potential.
ORGANIC	Containing carbon.
ORGANIC ACID FLUX (O/A)	Active flux easily removed with water. Provides excellent Printed Circuit Board (PCB) solderability.
pH	The measure of acidity or alkalinity of a solution or the reciprocal of the logarithm of the hydrogen ion concentration. The pH scale is from zero to 14, with 7.0 considered neutral; greater than 7.0 is alkaline (basic) and less than 7.0 is acidic. The greater the deviation from 7.0, the stronger the acid or base. There are many tests to determine pH, the most common being litmus paper.

POLAR	A term describing a substance at the atomic level which will breakdown in solution into positive and negative electrical components. A polar contaminant can only be dissolved by a polar solvent. Water is a polar solvent.
POLYPROPYLENE	A polymer of propylene that is a thermoplastic resin. It is often used in the manufacture of cleaning systems because of its ease of assembly, resistance to chemicals, and cost-effectiveness.
ppm	The abbreviation for parts per million.
PREWASH	The first stage in a cleaner. The function of this section is to remove gross contamination to drain, without carrying over into the recirculating wash station. In straight aqueous (non-saponified) systems, this stage should always go to drain or in a closed loop recycle system. In saponified systems, this stage should not be plain water, but should be an extension of the wash section, spraying saponified water on to the board.
PROCESS WINDOW	A term used to describe the range of settings for various process parameters within which success of the process is achieved.
REGENERANT	A solution of chemical compound used to restore the capacity of an ion exchange system. Sodium chloride brine is used as a regenerant for ion exchange water softeners, and acids and bases are used as regenerates for cation and anion resins used in demineralization.
RESIN	A solid or semi-solid organic (synthetic) compound lacking a crystalline structure. Resins are characterized by the lack of a definite melting point, and are usually not conductors of electricity. Natural resins originate in plants, such as pine sap, and are not water soluble. The rosin used in flux is a resin. Synthetic resins may have many or all of the properties of natural resins.
RINSE	A stage in the cleaning process of removing residual soils or wash solutions left from the previous stage. In a cleaning system, there may be multiple rinses, they may cascade, they may have fresh water inputs, and/or they may recirculate.
SALT	A compound formed by the reaction between an acid and a base. The hydrogen ion of the acid is replaced by the metal associated with the base, and the hydroxyl ion of the base is replaced by the negative ion from the acid. The hydrogen and hydroxyl ions combine to form water. A common example of the formation of a salt is table salt, NaCl, formed from the reaction of hydrochloric acid, HCl, and sodium hydroxide, NaOH. Salts ionize in water and are conductive.

SAPONIFIER	A general term applied to a solution of organic or inorganic bases and various agents, such as wetting agents and dispersants, for promoting the removal of non-water soluble contaminants, such as rosin fluxes, greases, oils, etc. The removal of rosin flux is based on the chemical reaction between acids in the rosin and the alkaline saponifier, which results in a water soluble or dispersible rosin "soap."
SEMI-AQUEOUS	As applied to cleaning, refers to a process of cleaning with a solvent in the wash stage, typically a terpene, hydrocarbon, or alcohol blend, followed by water rinse(s).
SOFT WATER	Processed water in which the calcium and/or magnesium ions causing hardness have been replaced through a water softening process with sodium ions. Caution must be taken when using softened water, as opposed to deionized water, in rinse stages because it may increase residual ionic readings.
SOFTENED WATER	Any water that is treated to reduce hardness minerals to 17.1 mg/L (1.0 gpg) or less, expressed as calcium carbonate.
SOLIDS CONTENT	In rosin fluxes, refers to the percentage by-weight of rosin and other solids in a particular formulation.
SOLUTION	A homogeneous mixture in which a solid, liquid or gas is dissolved in a liquid, called a solvent, and it forms a clear or transparent mixture.
SPRAY BAR	A pipe plumbed from a feed manifold having one or more spray nozzles on it.
SURFACE INSULATION RESISTANCE TEST (SIR)	An accelerated aging test that evaluates the resistance on the surface of a board which undergoes temperature and humidity cycling. Typically this test involves a grid test pattern on the board which has a bias voltage applied during testing. If conductive material remains on the board, when exposed to temperature and humidity cycling, this will manifest itself by decreasing the surface insulation resistance, which will be measurable. Mil-Std 2000 includes the acceptable test measurements. SIR testing usually takes 168 hours. While this test is highly accurate at the area evaluated, it does not provide an overall analysis for the entire board surface.

SURFACE TENSION	A property of liquids whereby molecular forces tend to contract the volume into a form with the least surface area. The higher the surface tension, the greater the tendency of a droplet to bead up from a flat surface. Droplets with lower surface tension tend to spread out, or wet the surface. Surface tension, in and of itself, is not an accurate measurement of a droplets ability to penetrate a tight space. Capillary action must also be evaluated. As a general rule, higher surface tension favors penetration, but lower tension favors rinsability. Surfactants can reduce surface tension of a liquid.
TURBINE BLOWER	A combination of a motor driving a rotary fan assembly, typically via belt, at very high rpm (relative to direct drive, or "squirrel cage" blowers). The effect is to produce a high velocity air flow which has proven to be very effective in drying when directed through an air knife.
VEE JET™ NOZZLE	A general term applied to spray nozzles which project a pattern like the letter "v" with the vertex emanating from the nozzle orifice. The spray may be flat or slightly elliptical. A round pattern is indicative of a cone nozzle.
WASH	Refers to the functional section or process within a cleaner in which the primary removal of contaminants takes place. The wash may be with straight water, straight solvent chemistry, or a mixture of water and saponifier or solvent.
WATER PURIFICATION	Any process that involves removing or reducing the level of suspended or dissolved contaminants from a water supply.
WATER SOFTENING	The removal of calcium and magnesium, the ions which are the principle cause of hardness, from water.
WATER SOLUBLE	Capable of being dissolved in or by water.
WHITE RESIDUE	A general name for a milky white residue that sometimes appears on the board after the cleaning process. There are many possible causes for this, some of which are functionally harmful, and some not. Possible causes include incomplete flux residue removal, leeching of material from the laminate, and incomplete cure of the solder resist on the board.

Index



A

- Airknives 28, 29
- Alarms
 - Action Types 62
 - Clearing 127
 - Configuration 61, 63
 - Configure Screen 40
 - End of Process Cycle 63
 - Final Rinse Flow Rate 63
 - Final Rinse Resistivity 63
 - Fluid Levels 24
 - Hardware 41
 - Not Programmable 41
 - Process 126
 - Repeating 127
 - Respond To 126
 - Screens 40
 - Speaker 41
 - Temperature 62
 - Troubleshooting 110
 - Wash/Rinse Flow Rate 63

B

- Blower
 - Drying 28
 - On/Off 116
- Breathing Hazards 6

C

- Chain Drive 21
- Chamber
 - Access Door 23
 - Carriage Conveyor 21
 - Daily Inspection 45
 - Description 21
 - Load Product 52
 - Mounting Rails 21, 52
- Check Lists 45
- Chemical Precautions 9
- Cleaning Terms and Definitions 130
- Component
 - Process Troubleshooting 112

Configuration

- Alarms 61, 63
- Optional System 29
- Options 65
- Recipe Parameters 98
- Standard System 29
- Units 64
- Control Panel
 - Alarm Speaker 41
 - Description 19
 - E-Stop Button 42
 - Gauges 37
 - Layout 36
 - LCD Touch Pad Unit 38
- Conveyor
 - Adjust Position 116
 - Carriage 21
 - Daily Inspection 45
 - Operation Troubleshooting 111
- Customer Support vii

D

- Daily Inspection
 - Access Panels 45
 - Cabinet 45
 - Chamber 45
 - Conveyor Carriage 45
 - Facility Connections 45
 - Facility Power 45
 - Rinse Tank 45
 - Wash Tank 45
- Debug Software 72
- Drying
 - Description 28
 - Process Troubleshooting 112

E

- Electrical
 - Daily Inspection 45
 - Facility Power 46
 - Lock-Out Tag-Out 12, 15

Emergency Stop
 Button 42
 Conditions 56
 Stop System Operation 56

Exhaust
 Vent Description 32
 Ventilation 9

F

Facility
 Connections 30
 Daily Inspection 45
 Electrical Requirements 46
 Exhaust Hook Up 32
 Lock-Out Tag-Out 11, 12, 15
 Final Rinse Option 27, 63, 101, 102
 Fire Extinguisher 8
 Flammables 8
 Float Switches 24

G

Gauges
 Description 37
 Pressure Checks 37
 Glossary 129
 Good Housekeeping 9
 Graphic Screens 40, 50, 105

H

Hardware Alarms 41
 Hazards
 Breathing 6
 Electric Shock 4
 Electrical 4
 Entanglement 5
 Heavy Objects 7
 High Voltage 4
 Hot Surface 3
 Mechanical 5
 Overview 2
 Skin Irritation 9
 Heaters
 Immersion 25
 Heavy Objects 7
 High Voltage 4
 Hot Surface Hazard 3

I

Immersion Heaters 25

L

LCD Touch Pad Unit 38
 Lock-Out Tag-Out
 Attach Facility Device 11
 Attach Machine Device 12
 Description 8, 10
 Machine Main Power Switch 13
 Remove Facility Device 15
 Remove Machine Device 15
 Shift Change Steps 10, 11, 14

M

Machine
 Clearance 8
 Noise Levels 8
 Machine Warning Label
 Electrical Hazard 4
 Entanglement Hazard 5
 Hot Surface 3
 Main Power Switch 13, 46
 Main Screen 40
 Maintenance Screens 40, 68, 115
 Manual Control
 Conveyor Position 116
 Description 116
 Fill/Drain Tank 116
 Pumps and Blower 116
 Mechanical Hazards 5
 Mounting Rails 21
 MSDS 8

N

Noise Level 8
 Nozzles 27, 29

O

Operation
 Machine Clearance 8
 Troubleshooting 110
 Options
 Configure Screen 40, 65
 Final Rinse 27
 List 33, 66

P

Plumbing 8
 Description 30
 Quick Release Clamps 30

Power
 Main Switch 46
 System Shut Down 54
 Preventive Maintenance
 Annual Technician 122
 Daily Operator 118
 Daily Technician 119
 Monthly Technician 120
 Safety 114
 Semi-Annual Technician 121
 Process
 Troubleshooting 112, 124
 Protective Clothing 9
 Pumps
 Filter 25
 On/Off 116
 Purge Nozzles 27

R

Reboot Software
 See Watchdog Timer Test 70
 Recipe
 Board Cleaning 90
 Cycles 98
 Edit Screen 40, 97
 Flow Rate 102
 General Cleaning 92
 Load Recipe Screen 49, 94
 Mis-Print Cleaning 91
 Parameter Table 97
 Parameters 97
 Predefined Overview 88
 Pressure 100
 Resistivity 101
 Screens 40, 49
 Stencil Cleaning 89
 Temperature 99
 Resistivity 101
 Rinse Cycle
 Flow Rate 102
 Flow Rate Alarm 63
 Pressure Control 100
 Temperature 99
 Temperature Alarm 61
 Rinse Nozzles 26
 Rinse Tank
 Description 24
 Fill 47
 Operation Troubleshooting 110

S

Safety
 Breathing 6
 Chemical Precautions 9
 Electrical Hazards 4
 Entanglement 5
 Fire Extinguisher 8
 Flammables 8
 Good Housekeeping 9
 Hazards List 2
 Heavy Objects 7
 Hot Surface 3
 Lock-Out Tag-Out 8, 10, 12, 15
 Machine Clearance 8
 MSDS 9
 No Smoking 8
 Noise Levels 8
 Overview 1
 Precautions 8
 Protective Clothing 9
 Respirator 6
 Skin Irritation 7
 Standards 9

Screens
 Alarms 40, 63
 Description 40
 Final Rinse Resistivity 101
 Flow Rate 102
 Graphics 40, 50, 105
 Main 40
 Maintenance 40, 115
 Options 40
 Pressure Control 100
 Process Cycles 98
 Recipe 40, 49
 Recipe Edit 40
 System Configuration 40, 58, 59, 95
 Tabular Process 40, 50, 104
 Temperature Alarm 61
 Temperature Control 99
 Thermocouple Information 40
 Units 40, 64
 Watchdog Timer 70
 Serial Tag x, 13
 Set Points
 Temperature 51
 Set Up
 Machine 45
 Skin Irritation 9
 Smoking Prohibition 8

Software
 Debug Process 72
 I/O Controller Board 82
 LCD Unit 84
 Reboot 70
 System Administrator Reference 57
 Upgrade Installation 80
 Upgrade Requirements 81
 Version Reference x, 71

Solenoids 24

Start Up
 Pre-Start Checklists 45

System
 Daily Inspection 45
 Shut Down 43
 Start Up 43

System Configuration
 Screen 40, 58, 59, 95

System Controls 19

System Description 18
 Blower Drying 28
 Chamber 21
 Configurations 29
 Control Panel 36
 Exhaust 32
 LCD Touch Pad Unit 38
 Optional Final Rinse 27
 Options 33
 Plumbing 30
 Purge Nozzles 27
 Rinse Nozzles 26
 Touch Pad Screens 40
 Wash Nozzles 26
 Wash/Rinse Tanks 24

System Operation
 Emergency Shut Down 56
 Normal Shut Down 55
 Start Up 44

T

Tabular Process Screens 40, 50, 104

Tanks

Automatically Fill 47
 Daily Inspection 45
 Description 24
 Drain Screen 25
 Fill Solenoids 24
 Float Switches 24
 Manual Fill 116
 Operation Troubleshooting 110
 Water Pump Filter 25

Temperature
 Alarms 24
 Process Troubleshooting 112
 Set Points 51

Thermocouples 24, 28, 40, 59, 95

Touch Pad
 Layout 39
 Screens 40

Troubleshooting
 Operation 110
 Process 112

U

Units Configuration 40, 64
 Upgrade Software 80

W

Wash Cycle
 Flow Rate 102
 Flow Rate Alarm 63
 Pressure Control 100
 Temperature 99
 Temperature Alarm 61

Wash Nozzles 26

Wash Tank
 Description 24
 Fill 47
 Operation Troubleshooting 110

Watchdog Timer Test 71

Water
 Pressure Gauges 37
 Process Troubleshooting 112

West 6700 Temperature Control
 Configuration Menu 76
 Description 74
 Set Up Menu 78