





Contents

	MY-Series_____	2
	Placement Machines_____	4
	Options_____	6
	Upgrades_____	14
	TP-Series_____	22
	Upgrades_____	24
	Accessories_____	30
	Board Handling_____	32
	Inline System_____	38
	Feeder System_____	60
	Placement Tools_____	84
	Software Products and Options_____	94
	Peripheral Accessories_____	104
	Glue System_____	108
	Miscellaneous_____	112
	Custom Products_____	116
	Board Handling_____	118
	In-line System_____	120
	Placement Tools_____	122

MY-Series

Whether you're building prototypes or running high-volume inline production, MYDATA machines have been designed to meet all your production needs. Based on a single platform, MY-Series machines combine feeder capacity and speed with the ability to place virtually any component – fine-pitch, BGAs, QFPs, chip scale BGAs, CSPs, flip chips, and 01005s – for virtually all your placement needs. The machine's modular design allows you to configure it for a range of board-handling applications, inline solutions such as T3 through T6, and manual-load options ranging from the ML3 to ML6. Plus, thanks to their split-axis design and rigid construction, our machines remain reliable and accurate far into the future.

MYDATA offers a full range of solutions, whether you're starting up a new business, or adding a high-mix, high-volume production line. Our machines range in size to match your feeder capacity requirements. Choose from our standard, compact MY9 and MY12 machines or the high-output MY15 and MY19. There is also the latest MY-Series Extended model, or combinations of two machines for the powerful inline solution we call MYSynergy. All MYDATA machines are backwards-compatible, meaning that they will grow with your business. Adding functionality or capacity is simply a matter of adding new hardware or upgrading your software.

MY9



Description

The MY9 machine is delivered standard with the high-accuracy Midas mounthead, TPSys operating system software and DVS vision system, making it an all-in-one solution for placing a wide range of components. The machine has 96 number of 8 mm feeder positions and can be configured with a range of board-handling solutions depending on your applications.

- 1 x Base Machine
- 1 x Y-module
- 1 x DVS vision system
- 1 x Midas mounthead
- 1 x TPSys operating system software
- 1 x Pentium processor control computer
- 1 x Board handling (500T, 400PT, ML or T-Series)
- 10 x Board edge supports (manual load)
- 4 x Support pins (manual load)
- 6 x Support pins (500T or 400PT conveyor)
- 2 x Wide board supports (500T and 400PT conveyor)
- 1 x Documentation set
- 1 x Spare part set 1
- 2 x LCD Monitors
- 1 x Keyboard and trackball

Part no.	Product name
L-040-0078	MY9

MY12



Description

The MY12 combines speed and ultra-fine pitch/BGA capability with a medium to large feeder capacity. Speed is provided by the optional HYDRA Speedmount and the ultra-fine pitch/BGA capability by the standard Midas mounthead. The MY12 is also equipped with the Dual Vision System (DVS) for alignment of fine pitch. The MY9 machine is delivered standard with the high-accuracy Midas mounthead, TPSys operating system software and DVS vision system, making it an all-in-one solution for placing a wide range of components. The machine has 112 number of 8 mm feeder positions and can be configured with a range of board-handling solutions depending on your applications.

- 1 x Base Machine
- 1 x Y-module

- 1 x DVS vision system
- 1 x Midas mounthead
- 1 x TPSys operating system software
- 1 x Pentium processor control computer
- 1 x Board handling (500T, 400PT, ML or T-Series)
- 10 x Board edge supports (manual load)
- 4 x Support pins (manual load)
- 6 x Support pins (500T or 400PT conveyor)
- 2 x Wide board supports (500T and 400PT conveyor)
- 1 x Documentation set
- 1 x Spare part set 1
- 2 x LCD Monitors
- 1 x Keyboard and trackball

Part no.	Product name
L-040-0079	MY12

MY15



Description

The MY15 machine is delivered standard with the high-accuracy Midas mounthead, TPSys operating system software and DVS vision system, making it an all-in-one solution for placing a wide range of components. The machine has 192 number of 8 mm feeder positions and can be configured with a range of board-handling solutions depending on your applications.

- 1 x Base Machine
- 1 x Y-module
- 1 x DVS vision system
- 1 x Midas mounthead
- 1 x TPSys operating system software
- 1 x Pentium processor control computer
- 1 x Board handling (500T, 400PT, ML or T-Series)
- 10 x Board edge supports (manual load)
- 4 x Support pins (manual load)
- 6 x Support pins (500T or 400PT conveyor)
- 2 x Wide board supports (500T and 400PT conveyor)
- 1 x Documentation set
- 1 x Spare part set 1
- 2 x LCD Monitors
- 1 x Keyboard and trackball

Part no.	Product name
L-040-0080	MY15

MY19



Description

The MY19 machine is delivered standard with the high-accuracy Midas mounthead, TPSys operating system software and DVS vision system, making it an all-in-one solution for placing a wide range of components. The machine has 256 number of 8 mm feeder positions and can be configured with a range of board-handling solutions depending on your applications.

- 1 x Base Machine
- 1 x Y-module
- 1 x DVS vision system
- 1 x Midas mounthead
- 1 x TPSys operating system software
- 1 x Pentium processor control computer
- 1 x Board handling (500T, 400PT, ML or T-Series)
- 10 x Board edge supports (manual load)
- 4 x Support pins (manual load)
- 6 x Support pins (500T or 400PT conveyor)
- 2 x Wide board supports (500T and 400PT conveyor)
- 1 x Documentation set
- 1 x Spare part set 1
- 3 x LCD Monitors
- 1 x Keyboard and trackball

Part no.	Product name
L-040-0081	MY19

MY9 Extended



Description

MY9 Extended base machine configured with the following:

1. Single LVS camera - included in the HYDRA 21k ER LVS
2. HYDRA 21k ER LVS - 04012
3. T3 internal conveyor - 00103

Part no.	Product name
P-009-0435	MY9 Extended

MY12 Extended



Description

MY12 Extended base machine configured with the following:

1. Single LVS camera - included in the HYDRA 21k ER LVS
2. HYDRA 21k ER LVS - 04022
3. T3 internal conveyor - 00103

Part no.	Product name
P-009-0436	MY12 Extended

MY15 Extended



Description

MY15 Extended base machine configured with the following:

1. Single LVS camera - included in the HYDRA 21k ER LVS
2. HYDRA 21k ER LVS - 04032
3. T3 internal conveyor - 00103

Part no.	Product name
P-009-0437	MY15 Extended

MY19 Extended



Description

MY19 Extended base machine configured with the following:

1. Single LVS camera - included in the HYDRA 21k ER LVS
2. HYDRA 21k ER LVS - 04042
3. T3 internal conveyor - 00103

Part no.	Product name
P-009-0438	MY19 Extended

T3 Inline Conveyor

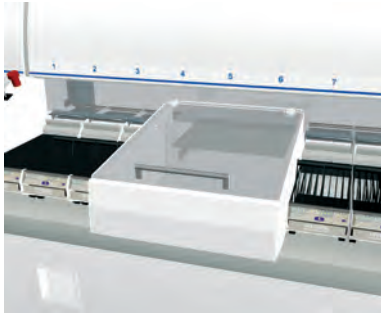

Description

Inline conveyor for board handling including linear drive y-unit and safety covers. The T3 conveyor, including one camera position occupies 3 magazine slots. Maximum board size is 443 x 508 mm (17.4" x 20.0"). Board train functionality and manual load adapter available as accessories.

Part no.	Product name
00103	T3 Inline Conveyor

T5 Inline Conveyor

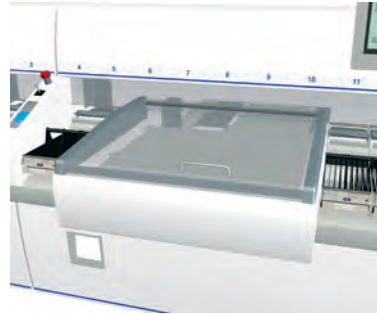

Description

Large size conveyor for inline board handling including linear drive y-unit and safety covers. The T5 conveyor, including two camera positions occupies 5 magazine slots. Maximum board size is 736 x 609 mm (29" x 24"). Board train functionality and manual load adapter available as accessories.

Part no.	Product name
00105	T5 Inline Conveyor

T4 Inline Conveyor

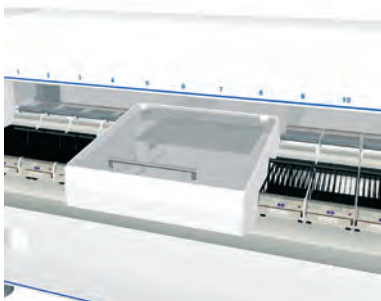

Description

Inline conveyor for board handling including linear drive y-unit and safety covers. The T4 conveyor, including two camera positions occupies 4 magazine slots. Maximum board size is 575 x 508 mm (22.6" x 20"). Board train functionality and manual load adapter available as accessories.

Part no.	Product name
00104	T4 Inline Conveyor

T6 Inline Conveyor

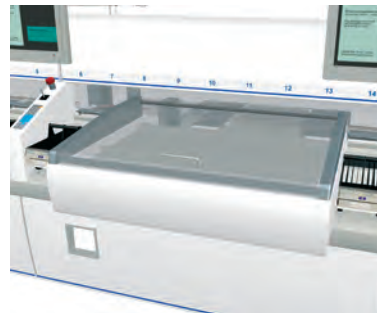

Description

Large size conveyor for inline board handling including linear drive y-unit and safety covers. The T6 conveyor, including two camera positions occupies 6 magazine slots. Maximum board size is 914 x 609 mm (36" x 24"). Board train functionality and manual load adapter available as options.

Part no.	Product name
00106	T6 Inline Conveyor

400PT Inline Conveyor

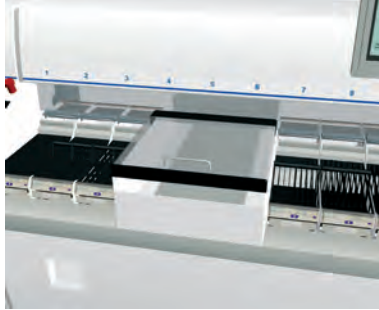

Description

Option for new machine: Internal Y Wagon Conveyor for the MY-Series Pass Through inline configuration.
 Maximum PCB size= 400 x 590 mm (15.7" x 23.2").
 Minimum PCB size= 50 x 50 mm (2.0" x 2.0").

Machine type:

MY9 , MY12 , MY15 , MY19

Part no.	Product name
00030	400PT Inline Conveyor

500T2 Inline Conveyor

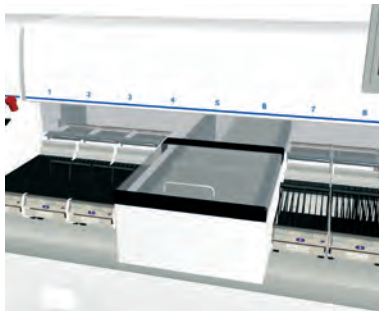

Description

Option for new machine: Internal Y Wagon Conveyor for the MY-Series Tee Style inline configuration.
 Maximum PCB size= 440 x 508 mm (17.3 x 20.0").
 Minimum PCB size= 50 x 50 mm (2.0" x 2.0").

Machine type:

MY9 , MY12 , MY15 , MY19

Part no.	Product name
0004	500T2 Inline Conveyor

ML3 Manual Load

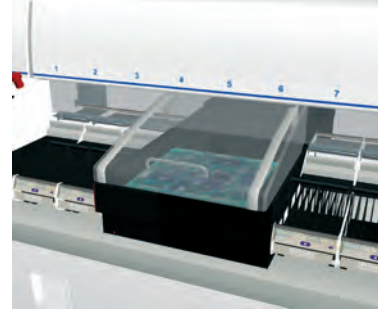

Description

Maximum board size (using magnetic supports) is 384 x 508 mm (15.1" x 20.0").
 Occupies 3 magazine modules.

Machine type:

MY9 , MY12 , MY15 , MY19

Part no.	Product name
0005	ML3 Manual Load

ML4 Manual Load

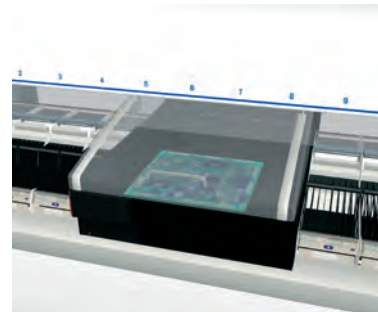

Description

Maximum board size (using magnetic supports) is 563 x 508 mm (22.1" x 20.0").
 Occupies 4 magazine modules.

Machine type:

MY9 , MY12 , MY15 , MY19

Part no.	Product name
0006	ML4 Manual Load

ML5 Manual Load

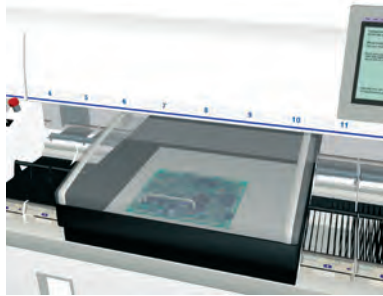

Description
 Maximum board size (using magnetic supports) is 745 x 610 mm (29.3" x 24.0").
 Occupies 5 magazine modules.

Machine type:
 MY9 , MY12 , MY15 , MY19

Part no.	Product name
0007	ML5 Manual Load

ML6 Manual Load

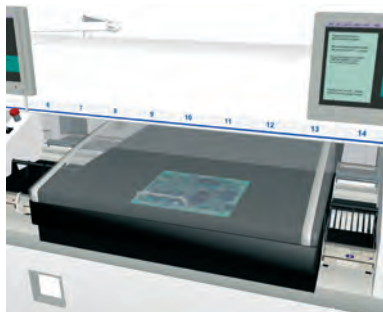

Description
 Maximum board size (using magnetic supports) is 932 x 732 mm (36.7" x 28.8").
 Occupies 6 magazine modules.

Machine type:
 MY9 , MY12 , MY15 , MY19

Part no.	Product name
0008	ML6 Manual Load

HYDRA Speedmount 14k



Description
 The HYDRA Speedmount is an eight-nozzle mounthead for high-speed mounting of a wide range of components. It is available as an option for all MY machines, and is the obvious choice for users who are experiencing or anticipate experiencing demand for higher capacity.

The HYDRA 14k places components at a top speed of 14,000 CPH and handles component types from 0402 chips to small SOICs and SSOPs.

Although the component range may vary, the automatic tool exchanger included keeps productivity at a peak. The HYDRA camera allows touchless centering of all components in one single pass. At the same time, each component is inspected and dimensionally verified. The system software, TPSys, always optimizes the route when picking and placing components, and tells the operator which feeders are to be positioned where to obtain optimal speed. If the capacity demands increases, it can easily be upgraded to 21,000 CPH top speed.

Part no.	Product name
04011	HYDRA 14k MY9
04011	HYDRA 14k MY12
04011	HYDRA 14k MY15
04011	HYDRA 14k MY19

HYDRA Speedmount 21k



Description

The HYDRA Speedmount is an eight-nozzle mounthead for high-speed mounting of a wide range of components. It is available as an option for all MY machines and is the obvious choice for users who are experiencing or anticipate experiencing a demand for higher capacity.

The HYDRA 21k places components at a top speed of 21,000 CPH and handles component types from 0402 chips to small SOICs and SSOPs.

Although the component range may vary, the automatic tool exchanger included keeps productivity at a peak. The HYDRA camera allows touchless centering of all components in one single pass. At the same time, each component is inspected and dimensionally verified. The system software, TPSys, always optimizes the route when picking and placing components, and tells the operator which feeders are to be positioned where to obtain optimal speed.

Part no.	Product name
04010	HYDRA 21k MY9
04020	HYDRA 21k MY12
04030	HYDRA 21k MY15
04040	HYDRA 21k MY19

HYDRA Speedmount 21k, ER LVS

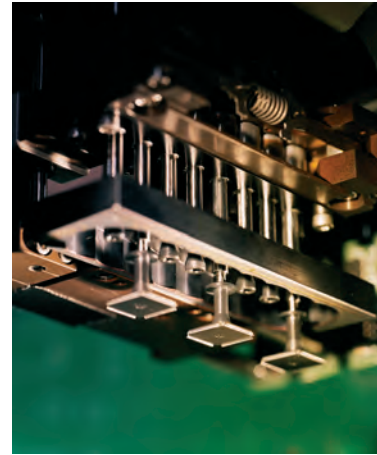

Description

The HYDRA Speedmount is an eight-nozzle mounthead for high-speed mounting of a wide range of components. It is available as an option for all MY machines, and is the obvious choice for users who are experiencing or anticipate experiencing demand for higher capacity.

The HYDRA 21k ER LVS places components at a top speed of 21,000 CPH and handles component types from 0201 chips to mid-sized SOICs and QFPs.

Although the component range may vary, the automatic tool exchanger included keeps productivity at a peak. The LVS camera allows touchless centering of all components in one single pass. At the same time, each component is inspected and dimensionally verified. The system software, TPSys, always optimizes the route when picking and placing components, and tells the operator which feeders are to be positioned where to obtain optimal speed.

Part no.	Product name
04012	HYDRA 21k MY9, ER LVS
04022	HYDRA 21k MY12, ER LVS
04032	HYDRA 21k MY15, ER LVS
04042	HYDRA 21k MY19, ER LVS

HYDRA Speedmount 21k, ER T-LVS

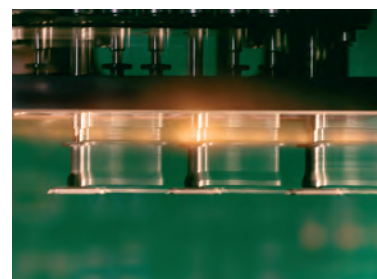

Description

The HYDRA Speedmount is an eight-nozzle mounthead for high-speed mounting of a wide range of components. It is available

as an option for all MY machines, and is the obvious choice for users who are experiencing or anticipate experiencing demand for higher capacity.

The HYDRA 21k ER T-LVS places components at a top speed of 21,000 CPH and handles component types from 0201 chips to mid-sized SOICs and QFPs. This option features a twin camera system, T-LVS, which increases the overall machine throughput.

Although the component range may vary, the automatic tool exchanger included keeps productivity at a peak. The LVS camera allows touchless centering of all components in one single pass. At the same time, each component is inspected and dimensionally verified.

The system software, TPSys, always optimizes the route when picking and placing components, and tells the operator which feeders are to be positioned where to obtain optimal speed.

Part no.	Product name
04016	HYDRA 21k MY9, ER T-LVS
04026	HYDRA 21k MY12, ER T-LVS
04036	HYDRA 21k MY15, ER T-LVS
04046	HYDRA 21k MY19, ER T-LVS

Linescan Vision System (LVS)

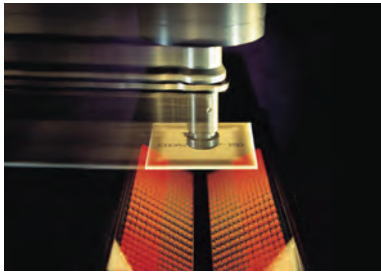

Description

The Linescan Vision System (LVS) is a high-speed, high-resolution optical centering system, which inspects and aligns fine-pitch components "on-the-fly" at a speed of 2 m/s, which gives a rated throughput of up to 6,100 CPH, at 2048 x 2048 pixel resolution. It ensures fast and accurate placement of all leaded and BGA-type components and is best suited when mount speed is critical.

The linescan camera can handle components up to 56 x 56 mm (2.2" x 2.2"), such as SMT connectors, BGAs with a pitch down to 0.3 mm (12 mil) as well as QFPs with a pitch down to 0.2 mm (8 mil). Larger components can be handled on request.

For two Linescan cameras, please order 04111.

Part no.	Product name
04110	Single Linescan Vision System
04111	Twin Linescan Vision System

Electrical Verifier

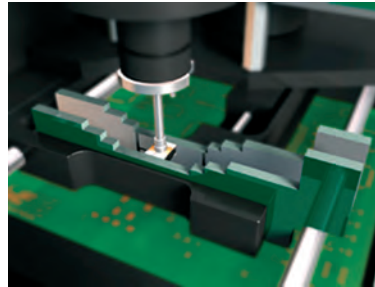

Description

Verifies the values of resistors, capacitors and diodes. For active polarized components the orientation is also checked.

To check transistors as well choose 3PT1 RCDT Verifier (0502).

Ordering info:

Please order L-010-0259 when ordering this as an upgrade.

Part no.	Product name
0501	2PT1 RCD Verifier
0502	3PT1 RCDT Verifier
0512	Logging EI. Measurement Software

Shared Databases



Description

Allows MYDATA machines to link together and share common databases such as component information, magazine data and mount list data. With Shared Databases all information is accessible to all machines from one place, making it simple, for example, to move jobs between machines. Also, instead of changing specific data values on every machine individually, a single entry on any networked machine will automatically update all the networked machines. The information is accessible by all networked machines running the same software version.

The necessary hardware can be arranged so that either a dedicated stand-alone PC, for faster database response, or one of the linked machines can act as the server, with all the other machines being clients. When three or more machines are to be networked, it is recommended that a stand-alone server be used (see Article L-010-0270 PC Server TPSys 2.x with UPS). With a stand-alone server, each networked machine can still retain its local database as a

backup, in case of server or network failure. Shared Databases are implemented using TCP/IP and require a local network with "ping time" less than 5 ms.

Machine type:

TP9-1 , TP9-2 , TP9-3 , TP9-4 , TP11 , TP12 , TP18 , MY9 , MY12 , MY15 , MY19

Requirements:

A local TCP/IP network with "ping time" less than 5 ms. Longer "ping time" will still work, but will slow down the user interface.

Ordering info:

Please order L-010-0259 when ordering this as an upgrade.

Part no.	Product name
0503	Shared Databases

Barcode Software

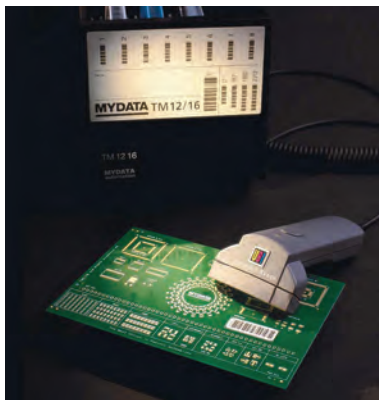

Description

To reduce operator intervention and eliminate the risk of human error, MYDATA provides two barcode functions in this Barcode Software product: one for magazine loading, and one for automatic mount program selection.

The magazine barcode reader eliminates manual data entry when loading parts into feeders. The conveyor barcode reader automatically selects the correct mount program when a barcoded PCB is presented to the placement machine. It can also read a PCB serial number from a barcoded PCB, and store this number in the Event Log.

MYDATA offers a hand-held barcode scanner for magazine loading as well as a fixed-mount scanner for conveyor installation. See L-010-0130, L-010-0131 and K-017-0191 for details. 2D barcode scanners can also be connected as long as they have a standard RS-232 interface.

Machine type:

TP9-1 , TP9-2 , TP9-3 , TP9-4 , TP11 , TP12 , TP18 , MY9 , MY12 , MY15 , MY19

Requirements:

Barcode Reader Magazine (L-010-0130, L-010-0131) or Barcode Reader Conveyor (K-017-0191) or other RS-232 compatible barcode reader.

Ordering info:

Please order L-010-0259 when ordering this as an upgrade.

Part no.	Product name
0506	Barcode Software

Pre-pick inspection



Description

Flip chips and CSPs generally come in trays or waffle packs. Very often, the pocket is much larger than the component itself, allowing the component to move around inside the pocket so that it ends up off center, at an angle, making it hard or impossible to pick the component. With this option you can use the downward-looking camera to inspect the tray before you pick the component and compensate for the offset, allowing you to pick the component exactly in the center even if it has moved around in the tray pocket. (This function will NOT check for orientation marks on the component.)

Maximum component size:

12 x 8 mm (for standard X-wagon camera with 14 x 11 mm FOV)
6 x 3 mm (for older or customized versions of the X-wagon camera with 8 x 6 mm FOV)

Pick level:

When picking from TEX pallets, the top surface of the component must be at least 7 mm above the bottom of the pallet, otherwise the component will be outside the depth-of-field (focus range) of the camera.

See also P-010-0821.

Requirements:

TPSys 2.4 or later

Ordering info:

Please order L-010-0259 / 0514 as an upgrade, or option 0514 together with a new machine.

Part no.	Product name
0514	Pre-pick inspection

Light Tower

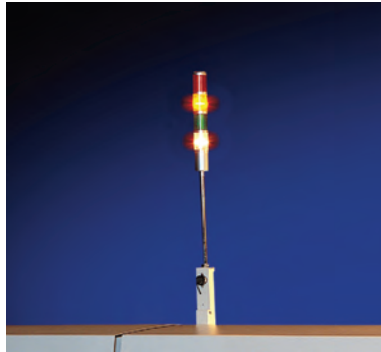

Description

An easy way to show the status of a placement machine, the tower has four different colored lights: red, yellow, green and white plus a buzzer. Seven different machine states (or events) can be signaled. The states are set through the machine software parameters.

Machine type:

MY12 , MY15 , MY19 , MY9 , TP9-2

Ordering info:

To be ordered together with a new machine.

Part no.	Product name
0491	Light Tower

Flexible Glue Station 2 for MY-Series



Description

Applying adhesive to a board by pin transfer may be done prior to component placement. Single or multiple glue dot patterns are defined in the package list for each package. This product is supplied with 2 glue pots and leveling arms. Occupies one magazine position.

Machine type:

MY12 , MY15 , MY19 , MY9

Part no.	Product name
04500	Flexible Glue Station 2 for MY-Series

Language - MY-Series

Description

A language needs to be chosen when ordering a new machine.

Part no.	Product name
0301	English US STD
0302	French US STD
0303	Spanish US STD
0304	Portug. US STD
0305	English EU STD
0306	French EU STD
0307	Spanish EU STD
0308	German EU STD
0309	Swedish EU STD
0310	Finnish EU STD
0311	Italian EU STD
0312	Dutch EU STD
0313	Portug. EU STD
0314	Norweg. EU STD
0315	Danish EU STD
0316	Japanese US STD

Voltage - MY-Series

Description

A voltage needs to be chosen when ordering a new machine.

Part no.	Product name
0201	Y 345/200V 3 phase EU
0202	Y 365/210V 3 phase EU
0203	Y 370/215V 3 phase EU
0204	Y 380/220V 3 phase EU
0205	Y 390/225V 3 phase EU
0206	Y 400/230V 3 phase EU
0207	Y 410/235V 3 phase EU
0208	Y 415/240V 3 phase EU
0209	Y 435/250V 3 phase EU
0210	D 190/110V 3 phase EU
0211	D 200/115V 3 phase EU
0212	D 210/121V 3 phase EU
0213	D 215/125V 3 phase EU
0214	D 220/127V 3 phase EU
0215	D 225/130V 3 phase EU
0216	D 230/133V 3 phase EU
0217	D 235/136V 3 phase EU
0218	D 240/140V 3 phase EU
0219	D 250/145V 3 phase EU
0220	D 200V 3 phase JPN
0230	D 190/100V 3 phase US
0232	D 210/121V 3 phase US
0238	D 240/140V 3 phase US

Part no.	Product name
0239	D 250/145V 3 phase US

ML3 Upgrade Kit for MY 288/468



Description

For upgrading MY-Series from 288/468 manual load to ML3. ML3 can be combined with 2 camera modules. Max. PCB size for ML3 (using magnetic supports)= 384 x 508 mm (15.1" x 20.0"). PCB thickness 0,5-4 mm (0,02"-0,016")
Occupies 3 magazine modules.

Machine type:

MY9 , MY12 , MY15 , MY19

Part no.	Product name
L-040-0067	ML3 Upgrade Kit for MY 288/468

ML4 Upgrade Kit for MY 288/468



Description

For upgrading MY-Series from 288/468 manual load to ML4. ML4 can be combined with 2 camera modules. Max. PCB size for ML4 (using magnetic supports)= 563 x 508 mm (22.1" x 20.0"). PCB thickness 0,5-4 mm (0,02"-0,016")
Occupies 4 magazine modules.

Machine type:

MY9 , MY12 , MY15 , MY19

Part no.	Product name
L-040-0068	ML4 Upgrade Kit for MY 288/468

ML5 Upgrade Kit for MY 288/468



Description

For upgrading MY-Series from 288/468 manual load to ML5. ML5 can be combined with 2 camera modules. Max. PCB size (using magnetic supports)= 745 x 610 mm (29.3" x 24.0"). PCB thickness 0,5-10 mm (0.02"-0.39")
Occupies 5 magazine modules.

Machine type:

MY9 , MY12 , MY15 , MY19

Part no.	Product name
L-040-0069	ML5 Upgrade Kit for MY 288/468

ML6 Upgrade Kit for MY 288/468



Description

For upgrading MY-Series from 288/468 manual load to ML6. ML6 can be combined with 2 camera modules. Max. PCB size (using magnetic supports)= 932 x 732 mm (36.7" x 28.8"). PCB thickness 0,5-10 mm (0.02"-0.39")
Occupies 6 magazine modules.

Machine type:

MY9 , MY12 , MY15 , MY19

Part no.	Product name
L-040-0070	ML6 Upgrade Kit for MY 288/468

Upgrade to Conveyor 500T2 MY-Series and TP-Series

Description

For upgrading to a Tee Style in-line configuration from a stand alone configuration.

This product includes a Y Wagon Conveyor plus a cable and adapter kit.

Maximum PCB size= 440 x 508 mm (17.3x20").

Minimum PCB size= 50 x 50 mm (2"x2")

Machine type:

TP9-4 , TP11 , TP12 , TP18 , MY9 , MY12 , MY15 , MY19 , HYDRA

Requirements:

See order guide P-040-0026 for details

Part no.	Product name
L-040-0047C	Upgrade to Conveyor 500T2 MY-Series and TP-Series

500T2 Hood Kit

Description

Hood kit for MY-Series and TP-Series Hydra machines upgrading to 500T2 configuration.

Part no.	Product name
00041	500T2 Hood Kit

Upgrade to Conveyor 400PT MY-Series and TP-Series

Description

For upgrading to a Pass Through in-line configuration from a stand alone configuration.

This product includes a Y Wagon Conveyor plus a cable and adapter kit.

Maximum PCB size= 399 x 590 mm (15.7"x23.2").

Minimum PCB size= 50 x 50 mm (2"x2").

Machine type:

TP9-4 , TP11 , TP12 , TP18 , MY9 , MY12 , MY15 , MY19

Requirements:

See order guide P-040-0026 for detailed information. Machines equipped with 500T conveyors can not be reconfigured to 400PT

Part no.	Product name
L-040-0046C	Upgrade to Conveyor 400PT MY-Series and TP-Series

400PT Hood Kit

Description

Hood kit for MY-series and TP-Series Hydra machines upgrading to 400PT configuration.

Machine type:

TP9-4 , TP11 , TP12 , TP18 , MY9 , MY12 , MY15 , MY19

Part no.	Product name
00031	400PT Hood Kit

HYDRA Speedmount Installation Kit



Description

This kit is used to upgrade machines with the HYDRA eight-nozzle head and the automatic tool exchanger (ATE) for increased productivity.

Please note: LVS camera is not included with options 04017, 04027, 04037, 04047. If no LVS is installed on the machine, please order the LVS installation kit L-040-0508 or L-040-0509.

Requirements:

Options 04014, 04024, 04034, 04044 require a MY-series machine, and TPSys 2.2 or later. Options 04017, 04027, 04037, 04047 require a MY-series machine, TPSys 2.4 or later, and LVS.

Ordering info:

Please add option 03604 or 04053 to the kit order if needed. Order form P-040-0014-EN must be enclosed.

Part no.	Product name
L-040-0496	HYDRA Speedmount installation kit
04014	HYDRA 21k MY9
04024	HYDRA 21k MY12
04034	HYDRA 21k MY15
04044	HYDRA 21k MY19
04017	HYDRA 21k ER For LVS MY9
04027	HYDRA 21k ER For LVS MY12
04037	HYDRA 21k ER For LVS MY15
04047	HYDRA 21k ER For LVS MY19
04053	TVS Slot Kit
03604	AT-CPU2 PF1 with CP5
03642	AT-CPU2 PF2 with CP5

HYDRA Speedmount 21K upgrade kit



Description

This kit is used to upgrade HYDRA from 14,400 CPH to 21,000 CPH performance. Please note: ATE and TPSys are not included.

Requirements:

MY-series machine with HYDRA, ATE and TPSys 2.2 or later

Ordering info:

Please add option 03604 to the kit order if needed. Order form P-040-0013-EN must be enclosed.

Part no.	Product name
L-040-0497	HYDRA Speedmount 21K upgrade kit
03604	AT-CPU2 PF1 with CP5
03642	AT-CPU2 PF2 with CP5

HYDRA Speedmount ATE upgrade kit



Description

This kit is used to upgrade HYDRA equipped machines with the Automatic Tool Exchanger (ATE). With the ATE, the HYDRA head automatically performs rapid tool changes that are optimized for each application and tool set-up. This can greatly improve the overall throughput of the machine. The ATE is especially useful for all medium- to high-mix production in which a wide range of different components and tools are used. Please note: TPSys is not included.

Machine type:
HYDRA

Requirements:

MY or TP series machine with HYDRA 2B or 2D, TPSys 2.2 or later

Part no.	Product name
L-040-0498	HYDRA Speedmount ATE upgrade kit

HYDRA Speedmount ER upgrade kit

Description

This kit is used to upgrade HYDRA 21k to HYDRA 21k ER (Extended range). ATE, LVS and TPSys are not included.

Machine type:
HYDRA

Requirements:

MY-series machine with HYDRA 2D 21k, ATE, TPSys 2.4 or later, LVS

Ordering info:

Order form P-040-0044-EN must be enclosed.

Part no.	Product name
L-040-0499	HYDRA Speedmount ER upgrade kit

MOT3-Z Upgrade for Hydra 2D on MY19

Description

Package for upgrading MY19 machines with serial number 19003 - 19040 with MOT3-Z. This is required when running Hydra 2D.

Machine type:
MY19

Part no.	Product name
L-010-0403	MOT3-Z Upgrade for Hydra 2D on MY19

Linescan Vision System (LVS)

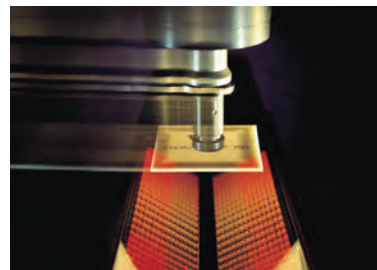

Description

The Linescan Vision System (LVS) is a high-speed, high-resolution optical centering system, which inspects and aligns fine-pitch components "on-the-fly" at a speed of 2 m/s, which gives a rated throughput of up to 6,100 CPH, at 2048 x 2048 pixel resolution. It ensures fast and accurate placement of all leaded and BGA-type components and is best suited when mount speed is critical.

The linescan camera can handle components up to 56 x 56 mm (2.2" x 2.2"), such as SMT connectors, BGAs with a pitch down to 0.3 mm (12 mil) as well as QFPs with a pitch down to 0.2 mm (8 mil). Larger components can be handled on request.

Requirements:

MY-Series machine, TPSys 2.3 or later, Midas mounthead.

Ordering info:

See order guide P-040-0008B for details.

Part no.	Product name
L-040-0508	Single LVS Installation Kit
03604	AT-CPU2 PF1 with CP5
03642	AT-CPU2 PF2 with CP5
L-040-0509	Second LVS Installation Kit

DVS For MY-Series Upgrade From SVS

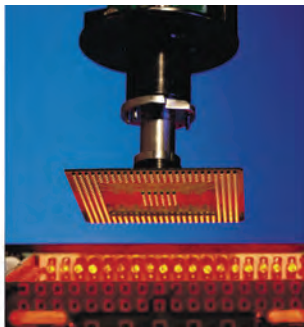

Description

For upgrading from SVS to DVS for a MY-Series machine. Dual Vision System (DVS) comprises two cameras in one box and can center and inspect chip scale BGAs, flip chips and CSPs by using a close-up feature. It can also handle all the components the Standard Vision System can handle, including large QFPs, by using its standard camera.

Maximum component size with TPSys 2.3 or later:
 51.9 x 51.9 mm (2.04" x 2.04") with Standard camera.
 15 x 15 mm (0.59" x 0.59") with Close-up camera.

Maximum component size with TPSys 2.0 - 2.2:
 51.9 x 51.9 mm (2.04" x 2.04") with Standard camera and Dual-shot mode (not BGA).
 51.9 x 39.0 mm (2.04" x 1.53") with Standard camera and Single-shot mode and BGA.
 15 x 11 mm (0.59" x 0.43") with Close-up camera.

Machine type:

MY9 , MY12 , MY15 , MY19

Requirements:

Software: TPSys 2.0 or later. Hardware: SVS. CP4 or CP5+VVG/VVG2.

Part no.	Product name
L-041-0213B	DVS For MY-Series Upgrade From SVS

MCU Upgrade Kit

Description

For upgrading machines with the Magazine Control Unit and CAN Communication. These functions are required to run Agilis linear magazines LM8 and LM1216.

Machine type:

TP9-1 , TP9-2 , TP9-3 , TP9-4 , TP11 , TP12 , TP18 , MY9 , MY12 , MY15 , MY19

Requirements:

TPSys 2.4 or later. AT-CPU with 166MHz processor or later.

Ordering info:

Please enclose MCU Platform Upgrade Order Guide P-040-0043-EN with the order.

Part no.	Product name
L-049-0485	MCU Upgrade Kit

TPSys SW Options Upgrade

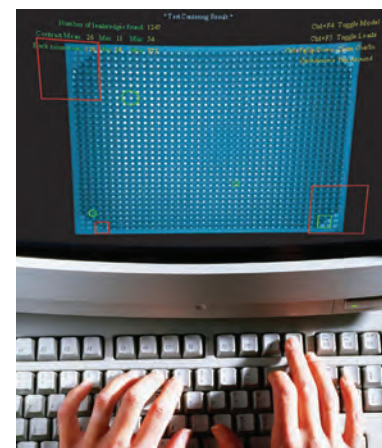

Description

For upgrading a machine with new software options. Please choose from options 0501, 0502, 0505, 0512, 0514, 0506 and 0503.

Machine type:

MY12 , MY15 , MY19 , MY9 , TP11 , TP12 , TP18 , TP9-1 , TP9-2 , TP9-3 , TP9-4

Ordering info:

Order form P-010-0043-EN must be included.

Part no.	Product name
L-010-0259	TPSys SW Options Upgrade

Electrical Verifier

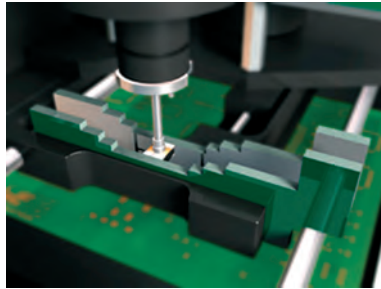

Description

Verifies the values of resistors, capacitors and diodes. For active polarized components the orientation is also checked.

To check transistors as well choose 3PT1 RCDT Verifier (0502).

Ordering info:

Please order L-010-0259 when ordering this as an upgrade.

Part no.	Product name
0501	2PT1 RCD Verifier
0502	3PT1 RCDT Verifier
0512	Logging EI. Measurement Software
0505	Upgrade from 2PT1 to 3PT1

Shared Databases



Description

Allows MYDATA machines to link together and share common databases such as component information, magazine data and mount list data. With Shared Databases all information is accessible to all machines from one place, making it simple, for example, to move jobs between machines. Also, instead of changing specific data values on every machine individually, a single entry on any networked machine will automatically update all the networked machines. The information is accessible by all networked machines running the same software version.

The necessary hardware can be arranged so that either a dedicated stand-alone PC, for faster database response, or one of the linked machines can act as the server, with all the other machines being clients. When three or more machines are to be networked, it is recommended that a stand-alone server be used (see Article L-010-0270 PC Server TPSys 2.x with UPS). With a stand-alone server, each networked machine can still retain its local database as a backup, in case of server or network failure. Shared Databases are implemented using TCP/IP and require a local network with "ping time" less than 5 ms.

Machine type:

TP9-1 , TP9-2 , TP9-3 , TP9-4 , TP11 , TP12 , TP18 , MY9 , MY12 , MY15 , MY19

Requirements:

A local TCP/IP network with "ping time" less than 5 ms. Longer "ping time" will still work, but will slow down the user interface.

Ordering info:

Please order L-010-0259 when ordering this as an upgrade.

Part no.	Product name
0503	Shared Databases

Barcode Software



Description

To reduce operator intervention and eliminate the risk of human error, MYDATA provides two barcode functions in this Barcode Software product: one for magazine loading, and one for automatic mount program selection.

The magazine barcode reader eliminates manual data entry when loading parts into feeders. The conveyor barcode reader automatically selects the correct mount program when a barcoded PCB is presented to the placement machine. It can also read a PCB serial number from a barcoded PCB, and store this number in the Event Log.

MYDATA offers a hand-held barcode scanner for magazine loading as well as a fixed-mount scanner for conveyor installation. See L-010-0130, L-010-0131 and K-017-0191 for details. 2D barcode scanners can also be connected as long as they have a standard RS-232 interface.

Machine type:
TP9-1 , TP9-2 , TP9-3 , TP9-4 , TP11 , TP12 , TP18 , MY9 , MY12 , MY15 , MY19

Requirements:
Barcode Reader Magazine (L-010-0130, L-010-0131) or Barcode Reader Conveyor (K-017-0191) or other RS-232 compatible barcode reader.

Ordering info:
Please order L-010-0259 when ordering this as an upgrade.

Part no.	Product name
0506	Barcode Software

Pre-pick inspection



Description
Flip chips and CSPs generally come in trays or waffle packs. Very often, the pocket is much larger than the component itself, allowing the component to move around inside the pocket so that it ends up off center, at an angle, making it hard or impossible to pick the component. With this option you can use the downward-looking camera to inspect the tray before you pick the component and compensate for the offset, allowing you to pick the component exactly in the center even if it has moved around in the tray pocket. (This function will NOT check for orientation marks on the component.)

Maximum component size:
12 x 8 mm (for standard X-wagon camera with 14 x 11 mm FOV)
6 x 3 mm (for older or customized versions of the X-wagon camera with 8 x 6 mm FOV)

Pick level:
When picking from TEX pallets, the top surface of the component must be at least 7 mm above the bottom of the pallet, otherwise the component will be outside the depth-of-field (focus range) of the camera.

See also P-010-0821.

Requirements:
TPSys 2.4 or later

Ordering info:
Please order L-010-0259 / 0514 as an upgrade, or option 0514 together with a new machine.

Part no.	Product name
0514	Pre-pick inspection

Midas Upgrade Kit

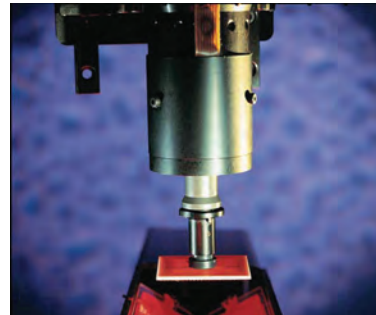

Description
For upgrading a MY-Series machine with the Midas single-nozzle mounthead. Midas is a powerful solution designed for ultra-sharp precision and increases the overall machine performance substantially. It ensures that even the most complex components, such as QFPs, BGAs and CSPs are placed with a great deal of sensitivity and accuracy.

Part no.	Product name
L-010-0457	Midas Upgrade Kit

LCD Monitor upgrade kit MY9-MY15

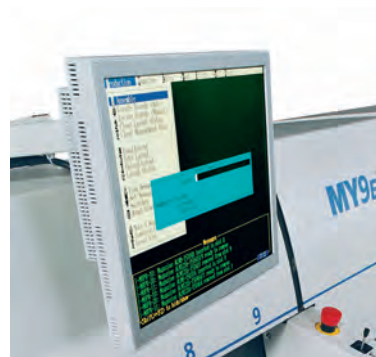

Description
The LCD Monitor upgrade kit is used for reconfiguring from CRT to LCD monitor systems. The package includes 15" LCD monitors for the machine and the workstation, monitor arm, accessories and an Installation Guide. LCD monitors require less space, weigh less and consume less power compared to ordinary CRT monitors. The LCD monitor has high resolution, high luminance and a high contrast ratio as well as a

great viewing angle. The adjustable monitor arm improves the ergonomics of working with the monitor.

Requirements:

MY9-MY15 Generation I0 and later

Part no.	Product name
L-040-0468	LCD Monitor upgrade kit MY9-MY15

LCD Monitor upgrade kit MY19

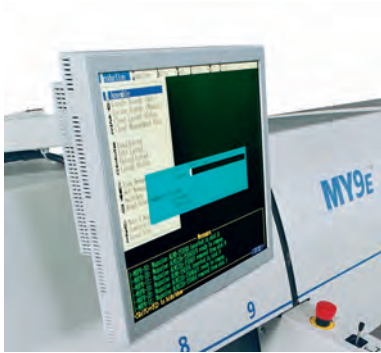

Description

The LCD Monitor upgrade kit is used for reconfiguring from CRT to LCD monitor systems. The package includes 15" LCD monitors for the machine and the workstation, monitor arm, accessories and an Installation Guide.

LCD monitors require less space, weigh less and consume less power compared to ordinary CRT monitors. The LCD monitor provides high resolution, high luminance and a high contrast ratio as well as a great viewing angle. The adjustable monitor arm improves the ergonomics of working with the monitor.

Requirements:

MY19 Generation I0 and later

Part no.	Product name
L-040-0471	LCD Monitor upgrade kit MY19



**MYDATA
TP9-UFP**

1 2 3 4 5 6 7 8 9

7 8

TP-Series

MYDATA TP Series of placement machines offer surface mount technology that is very flexible, reliable and cost-effective. Operating in the medium speed range, with production speeds up to 14,400 components per hour (CPH), they are ideal for medium to high volume, high-mix PCB production.

Like all other MYDATA machine series, the TP Series is designed to grow with you, no matter what production demands you may face. That's why we offer several different upgrades for machines that are already in production. Depending on your requirements, upgrades such as different board handling systems, mountheads, software, electrical/dimensional verification "on-the fly" etc, are available.

In short, a wide range of possibilities to keep your production efficient and competitive.

Y Wagon Table 288

Description

Max. PCB size (using magnetic supports)= 269 x 454 mm (10.60"x17.87").
 Max. placement area= 298 x 472 mm (11.73"x18.58").
 Occupies 1 2/3 magazine modules and allows room for a glue station.

Machine type:

TP9-1 , TP9-2 , TP9-3 , TP9-4 , TP11 , TP12 , TP18

Requirements:

Non-HYDRA machine.

Part no.	Product name
L-015-0367	Y Wagon Table 288

Y Wagon Table 348

Description

Max. PCB size (using magnetic supports)= 329 x 454 mm (12.95"x17.87").
 Max. placement area= 358 x 472 mm (14.09"x18.58").
 Occupies 2 magazine modules. A glue station cannot be used.

Machine type:

TP9-1 , TP9-2 , TP9-3 , TP9-4 , TP11 , TP12 , TP18

Requirements:

Non-HYDRA machine.

Part no.	Product name
L-015-0368	Y Wagon Table 348

Y Wagon Table 468

Description

Max. PCB size (using magnetic supports)= 449 x 454 mm (17.68"x17.87").
 Max. placement area= 478 x 472 mm (18.52"x18.58").
 Occupies 2 2/3 magazine modules and allows room for a glue station.

Machine type:

TP9-1 , TP9-2 , TP9-3 , TP9-4 , TP11 , TP12 , TP18

Requirements:

Non-HYDRA machine.

Part no.	Product name
L-015-0369	Y Wagon Table 468

Y Wagon Table 528

Description

Max. PCB size (using magnetic supports)= 509 x 454 mm (20.04"x17.87").
 Max. placement area= 538 x 472 mm (21.18"x18.58").
 Occupies 3 magazine modules. A glue station cannot be used.

Machine type:

TP9-2 , TP9-4 , TP11

Part no.	Product name
L-015-0370	Y Wagon Table 528

Y Wagon Table Upgrade

Description

Kit for upgrading old Y Wagons (11",13",18", & 21") to make them compatible with new Y Wagon tables. This kit does not include the new table which is sold separately.

Machine type:

TP9-1 , TP9-2 , TP9-3 , TP9-4 , TP11 , TP12 , TP18

Part no.	Product name
L-015-0315	Y Wagon Table Upgrade

Y Wagon Table Upgrade 288 for HYDRA

Description

This kit is for upgrading to a 288 Y Wagon table from a 468 Y Wagon table for the HYDRA Speedmount. This will provide a larger PCB assembly area.

Max. PCB size (using magnetic supports)= 259 x 562 mm (17.28"x22.13").

Max. placement area= 288 x 580 mm (18.43"x22.83").

Occupies 2 2/3 magazine modules. The HYDRA camera occupies 1/3 magazine module therefore a glue station cannot be used. Safety covers for the Y Wagon are included.

Machine type:

TP9-4 , TP11

Part no.	Product name
L-015-0375	Y Wagon Table Upgrade 288 for HYDRA

Y Wagon Table Upgrade 468 for HYDRA

Description

This kit is for upgrading to a 468 Y Wagon table from a 288 Y Wagon table for the HYDRA Speedmount. This will create an extra magazine module.

Max. PCB size (using magnetic supports)= 439 x 562 mm (10.20"x22.13").

Max. placement area= 468 x 580 mm (11.34"x22.83").

Occupies 1 2/3 magazine modules. The HYDRA camera occupies 1/3 magazine module therefore a glue station cannot be used. Safety covers for the Y Wagon are included.

Machine type:
TP9-4 , TP11

Part no.	Product name
L-015-0376	Y Wagon Table Upgrade 468 for HYDRA

Upgrade to Conveyor 500T2 MY-Series and TP-Series

Description

For upgrading to a Tee Style in-line configuration from a stand alone configuration. This product includes a Y Wagon Conveyor plus a cable and adapter kit. Maximum PCB size= 440 x 508 mm (17.3x20"). Minimum PCB size= 50 x 50 mm (2"x2")

Machine type:
TP9-4 , TP11 , TP12 , TP18 , MY9 , MY12 , MY15 , MY19 , HYDRA

Requirements:
See order guide P-040-0026 for details

Part no.	Product name
L-040-0047C	Upgrade to Conveyor 500T2 MY-Series and TP-Series

500T2 Hood Kit

Description

Hood kit for MY-Series and TP-Series Hydra machines upgrading to 500T2 configuration.

Part no.	Product name
00041	500T2 Hood Kit

Upgrade to Conveyor 400PT MY-Series and TP-Series

Description

For upgrading to a Pass Through in-line configuration from a stand alone configuration. This product includes a Y Wagon Conveyor plus a cable and adapter kit. Maximum PCB size= 399 x 590 mm (15.7"x23.2"). Minimum PCB size= 50 x 50 mm (2"x2").

Machine type:
TP9-4 , TP11 , TP12 , TP18 , MY9 , MY12 , MY15 , MY19

Requirements:

See order guide P-040-0026 for detailed information. Machines equipped with 500T conveyors can not be reconfigured to 400PT

Part no.	Product name
L-040-0046C	Upgrade to Conveyor 400PT MY-Series and TP-Series

400PT Hood Kit

Description

Hood kit for MY-series and TP-Series Hydra machines upgrading to 400PT configuration.

Machine type:

TP9-4 , TP11 , TP12 , TP18 , MY9 , MY12 , MY15 , MY19

Part no.	Product name
00031	400PT Hood Kit

HYDRA Speedmount ATE upgrade kit



Description

This kit is used to upgrade HYDRA equipped machines with the Automatic Tool Exchanger (ATE). With the ATE, the HYDRA head automatically performs rapid tool changes that are optimized for each application and tool set-up. This can greatly improve the overall throughput of the machine. The ATE is especially useful for all medium- to high-mix production in which a wide range of different components and tools are used. Please note: TPsys is not included.

Machine type:

HYDRA

Requirements:

MY or TP series machine with HYDRA 2B or 2D, TPsys 2.2 or later

Part no.	Product name
L-040-0498	HYDRA Speedmount ATE upgrade kit

SVS Installation Kit

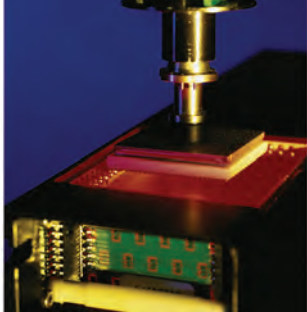

Description

The SVS (Standard Vision System) can center a component with a maximum size of 39 x 39 mm (1.54" x 1.54"). The field of view is 39 x 50.8 mm (1.54" x 2"). Older TP9-2U machines might need parts retrofitted.

The SVS works by forming a mathematical model of the component as described in the package list and compares it to the actual image of the component to be centered.

Requirements:
TPSys 1.5 or later.

Ordering info:

Please state serial number of machine when ordering.

Part no.	Product name
L-010-0211C	SVS For TP9-2U Installation Kit
L-010-0310C	SVS For TP9-3/4/TP11 Installation Kit
L-020-0005C	SVS For TP12/18-UFP Installation Kit

DVS Installation Kit

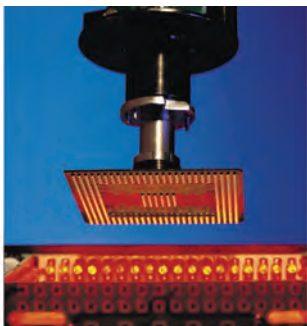

Description

The DVS (Dual Vision System) comprises two cameras in one product, it can center and inspect Chip Scale BGAs, Flip Chips and CSPs by using a close-up feature. It can also handle all the components the Standard Vision System can handle, including large QFPs, by using its standard camera.

When using the close-up feature, the DVS can center components whose lead pattern does not exceed 15 x 11 mm (0.59" x 0.43") (this dimension is known as the Active Field of View - AFOV). When

using the standard camera, the DVS can center a component whose leads do not exceed an AFOV of 51.9 x 51.9 mm (2.04" x 2.04") in dual shot mode (except BGA). For single shot (and BGA), the maximum AFOV is 51.9 x 39.0 mm (2.04" x 1.53").

The Dual Vision System works by forming a mathematical model of the component as described in the package list and compares it to the actual image of the component to be centered. All types of ball arrays can be handled including asymmetric and staggered lead configurations and missing corner leads. Irregular lead configurations can also be mounted, by defining it in the generic package editor.

Requirements:

Software: TPSys 2.0 or later. Hardware: CP4, CP5+VVG/VVG2.

Part no.	Product name
L-011-0044	DVS For TP9-4/TP11 Installation Kit
L-011-0047	DVS For TP12/18 Installation Kit

OVS-SVS Upgrade

Description

For upgrading from OVS to SVS.

Part no.	Product name
L-011-0052	OVS-SVS Upgrade TP9-2U
L-011-0053	OVS-SVS Upgrade TP9-4/11
L-011-0054	OVS-SVS Upgrade TP12/18

DVS Upgrade

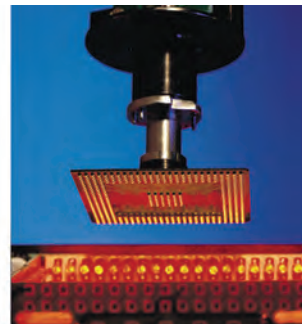

Description

For upgrading from SVS to DVS for a TP9-UFP or TP11-UFP. It comprises two cameras in one product and can center and inspect chip scale BGAs, flip chips and CSPs by using a close-up feature. It can also handle all the components the Standard Vision System can handle, including large QFPs, by using its standard camera.

When using the close-up feature, the DVS can center components whose lead pattern does not exceed 15 x 11 mm (0.59" x 0.43") (this dimension is known as the Active Field of View - AFOV). When using the standard camera, the DVS can center a component whose leads do not exceed an AFOV of 51.9 x 51.9 mm (2.04" x 2.04") in dual shot mode (except BGA). For single shot (and BGA), the maximum AFOV is 51.9 x 39.0 mm (2.04" x 1.53").

The Dual Vision System works by forming a mathematical model of the component as described in the package list and compares it to the actual image of the component to be centered. All types of ball arrays can be handled including asymmetric and staggered lead configurations and missing corner leads. Irregular lead configurations can also be mounted, by defining it in the generic package editor.

Requirements:
Standard Vision System. Software: TPSys 2.0 or later. Hardware: CP4, CP5+VVG/VVG2.

Part no.	Product name
L-011-0049	DVS For TP9-4/TP11 Upgrade From SVS
L-011-0048	DVS For TP12/18 Upgrade From SVS

MCU Upgrade Kit

Description
For upgrading machines with the Magazine Control Unit and CAN Communication. These functions are required to run Agilis linear magazines LM8 and LM1216.

Machine type:
TP9-1 , TP9-2 , TP9-3 , TP9-4 , TP11 , TP12 , TP18 , MY9 , MY12 , MY15 , MY19

Requirements:
TPSys 2.4 or later. AT-CPU with 166MHz processor or later.

Ordering info:
Please enclose MCU Platform Upgrade Order Guide P-040-0043-EN with the order.

Part no.	Product name
L-049-0485	MCU Upgrade Kit

TPSys SW Options Upgrade

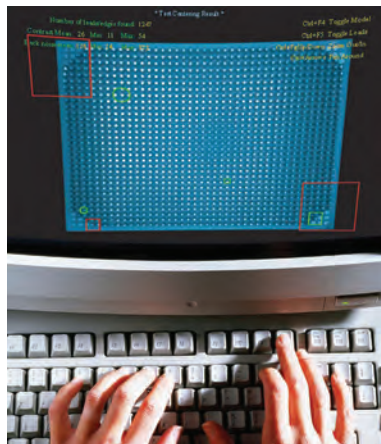

Description

For upgrading a machine with new software options. Please choose from options 0501, 0502, 0505, 0512, 0514, 0506 and 0503.

Machine type:

MY12 , MY15 , MY19 , MY9 , TP11 , TP12 , TP18 , TP9-1 , TP9-2 , TP9-3 , TP9-4

Ordering info:

Order form P-010-0043-EN must be included.

Part no.	Product name
L-010-0259	TPSys SW Options Upgrade

Electrical Verifier

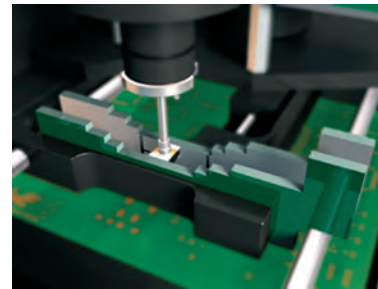

Description

Verifies the values of resistors, capacitors and diodes. For active polarized components the orientation is also checked.

To check transistors as well choose 3PT1 RCDT Verifier (0502).

Ordering info:

Please order L-010-0259 when ordering this as an upgrade.

Part no.	Product name
0501	2PT1 RCD Verifier
0502	3PT1 RCDT Verifier
0512	Logging EI. Measurement Software
0505	Upgrade from 2PT1 to 3PT1

Shared Databases



Description

Allows MYDATA machines to link together and share common databases such as component information, magazine data and mount list data. With Shared Databases all information is accessible to all machines from one place, making it simple, for example, to move jobs between machines. Also, instead of changing specific data values on every machine individually, a single entry on any networked machine will automatically update all the networked machines. The information is accessible by all networked machines running the same software version.

The necessary hardware can be arranged so that either a dedicated stand-alone PC, for faster database response, or one of the linked machines can act as the server, with all the other machines being clients. When three or more machines are to be networked, it is recommended that a stand-alone server be used (see Article L-010-0270 PC Server TPSys 2.x with UPS). With a stand-alone server, each networked machine can still retain its local database as a backup, in case of server or network failure. Shared Databases are implemented using TCP/IP and require a local network with "ping time" less than 5 ms.

Machine type:

TP9-1 , TP9-2 , TP9-3 , TP9-4 , TP11 , TP12 , TP18 , MY9 , MY12 , MY15 , MY19

Requirements:

A local TCP/IP network with "ping time" less than 5 ms. Longer "ping time" will still work, but will slow down the user interface.

Ordering info:

Please order L-010-0259 when ordering this as an upgrade.

Part no.	Product name
0503	Shared Databases

Barcode Software



Description

To reduce operator intervention and eliminate the risk of human error, MYDATA provides two barcode functions in this Barcode Software product: one for magazine loading, and one for automatic mount program selection.

The magazine barcode reader eliminates manual data entry when loading parts into feeders. The conveyor barcode reader automatically selects the correct mount program when a barcoded PCB is presented to the placement machine. It can also read a PCB serial number from a barcoded PCB, and store this number in the Event Log.

MYDATA offers a hand-held barcode scanner for magazine loading as well as a fixed-mount scanner for conveyor installation. See L-010-0130, L-010-0131 and K-017-0191 for details. 2D barcode scanners can also be connected as long as they have a standard RS-232 interface.

Machine type:

TP9-1 , TP9-2 , TP9-3 , TP9-4 , TP11 , TP12 , TP18 , MY9 , MY12 , MY15 , MY19

Requirements:

Barcode Reader Magazine (L-010-0130, L-010-0131) or Barcode Reader Conveyor (K-017-0191) or other RS-232 compatible barcode reader.

Ordering info:

Please order L-010-0259 when ordering this as an upgrade.

Part no.	Product name
0506	Barcode Software

Pre-pick inspection



Description

Flip chips and CSPs generally come in trays or waffle packs. Very often, the pocket is much larger than the component itself, allowing the component to move around inside the pocket so that it ends up off center, at an angle, making it hard or impossible to pick the component. With this option you can use the downward-looking camera to inspect the tray before you pick the component and compensate for the offset, allowing you to pick the component exactly in the center even if it has moved around in the tray pocket. (This function will NOT check for orientation marks on the component.)

Maximum component size:

12 x 8 mm (for standard X-wagon camera with 14 x 11 mm FOV)
 6 x 3 mm (for older or customized versions of the X-wagon camera with 8 x 6 mm FOV)

Pick level:

When picking from TEX pallets, the top surface of the component must be at least 7 mm above the bottom of the pallet, otherwise the component will be outside the depth-of-field (focus range) of the camera.

See also P-010-0821.

Requirements:

TPSys 2.4 or later

Ordering info:

Please order L-010-0259 / 0514 as an upgrade, or option 0514 together with a new machine.

Part no.	Product name
0514	Pre-pick inspection

Monitor**Description**

Monitor upgrades for TP-series machines.

Ordering info:

Please state serial number of machine when ordering.

Part no.	Product name
L-010-0117	Color Monitor Upgrade TP9-1/2/3
L-020-0067	Color Monitor Upgrade TP12/18
L-019-1033	VGA FOR TP9-1/2/3/4 & 11 W CB1
L-019-1034	VGA FOR TP9-2/4 & TP11 W CB2
L-019-1032	VGA FOR TP12/18



Accessories

This section contains all the accessories available for your MYDATA placement machine. You will find software products, feeders, conveyor equipment and much more. You'll see the range of products available is testimony to MYDATA's dedication in providing you with flexibility and total quality.

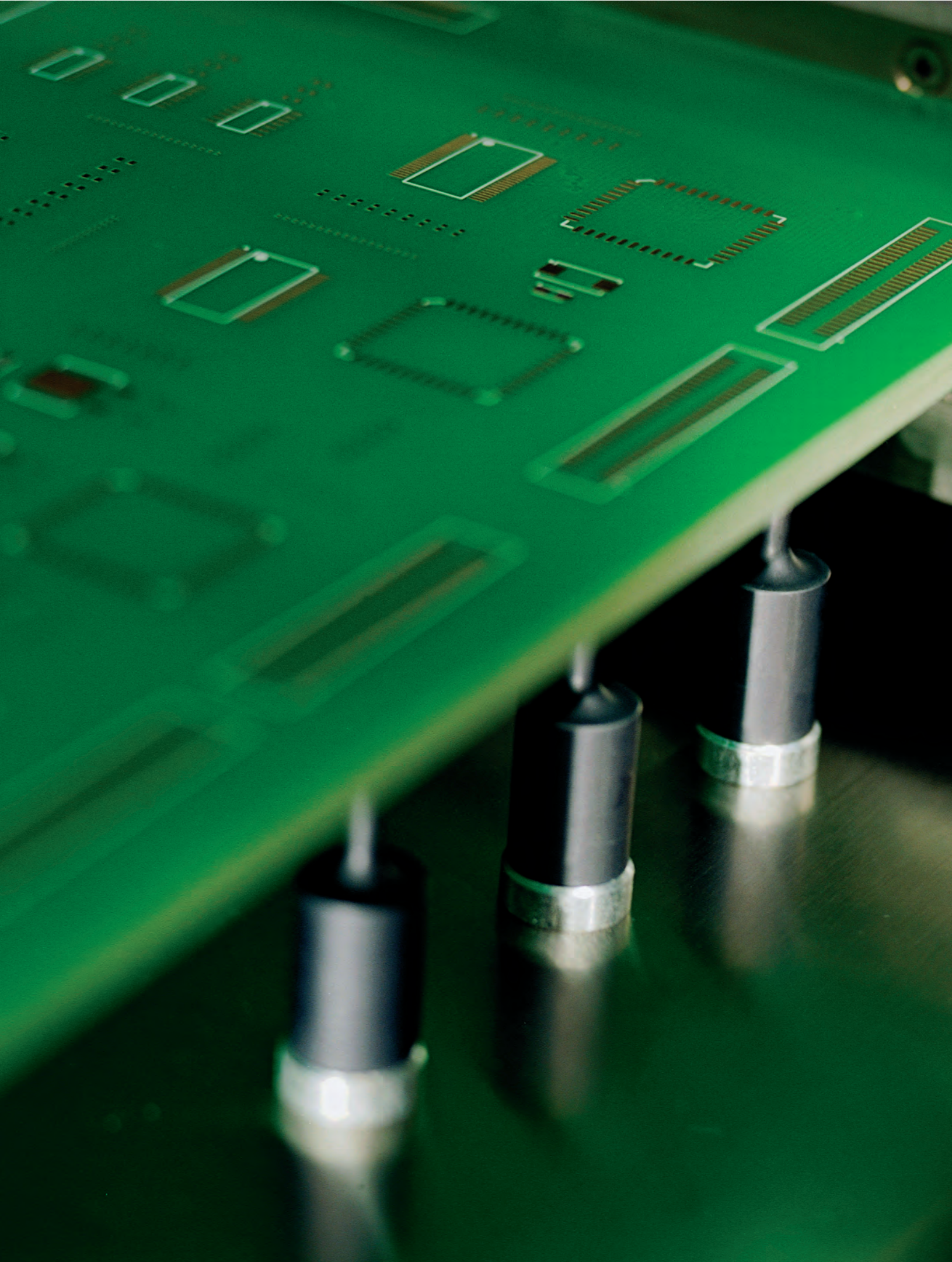

Board Handling

In today's complex and often fast-changing production environments, it often takes more than just a machine to produce your boards. You also need a reliable and robust board-handling solution. That's why MYDATA products can be configured to handle different board shapes and sizes plus your level of automation – to meet your specific needs. In a competitive market it helps to know that you can come to us with your application requirements and we'll propose a solution – standard or custom-designed, just for you.

Support Pin ML



Description
Magnetic support pin used for all manual load tables.

Part no.	Product name
L-015-1562	ML Support Pin 3 - 8 mm
L-015-1548	ML Support Pin 8 - 10 mm
L-015-1023	ML Support Pin 0.5 - 4 mm

Board Edge Support



Description
The Board Edge Support is used for securing the edge of the PCB to prevent movement. Each support handles one PCB on either side. The board edge support attaches to the Y Wagon magnetically.

Part no.	Product name
L-015-0444	ML Board Edge Support 0.5 - 4 mm
L-015-1561	ML Board Edge Support 3 - 8 mm
L-015-1547	ML Board Edge Support 8 - 10 mm
L-015-0009B	ML Board Edge Support TP

Fixture Plate Holder

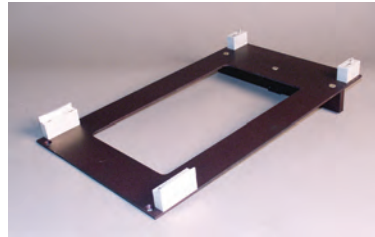

Description
The fixture plate is ideal for use with ceramic substrates and lead-frames. The aluminium fixture plates can easily be designed and machined by MYDATA customers themselves with tooling holes or track guides to fit specific boards and meet particular needs.

The fixture plate (purchased separately) sits on top of the fixture plate holder, which in turn is easily fitted to the Y Wagon. Applications are almost limitless, for example one can use the fixture plate kit to speed up production, several PCBs can be prepared in advance enabling the operator to change groups of PCBs over at once rather than individually. Placement area= 279 x 457 mm (11" x 18").

The fixture plate holder fits on non hydra TP-machines.

Requirements:
Fixture Plate L-015-0014 or L-015-0026.

Part no.	Product name
L-015-0013B	Fixture Plate Holder
L-015-0014	Fixture Plate 11 x 18"
L-015-0026	Fixture Plates. Set of 10

Support Pin 500T2/400PT



Description
Magnetic board support pin for conveyors.

Part no.	Product name
L-015-0256C	Support Pin 500T2/400PT

T-Series Support Pin



Description
Magnetic support pin used for all T-Series conveyors.

Part no.	Product name
L-015-0010B	T-Series Support Pin

Wide board support 500T2

Description
Extra wide magnetic board support for 500T2 conveyors. Provides extra support on the edges on large boards. Replaces L-025-0148.

Part no.	Product name
L-025-0241	Wide board support 500T2

Manual Load Adapter 500T2



Description
The adapter allows an inline machine to be used for stand-alone assembly. The adapter is placed on the conveyor and fixed with four supplied bolts. Maximum board area is 427 x 461 mm (16.8" x 18").

Requirements:
500T2 Conveyor.

Part no.	Product name
L-025-0215	Manual Load Adapter 500T2

Manual Load Adapter T3

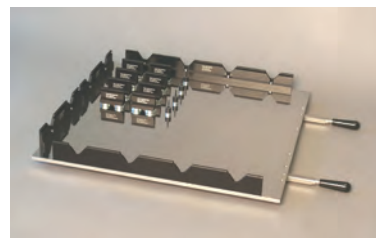

Description
Adapter to turn T3 conveyor into a manual load table. Maximum board size: 419 x 443 mm (16.5" x 17.4"). Includes board edge support and support pins for the board thickness range 0.5 - 4 mm.

Requirements:
T3 conveyor

Part no.	Product name
L-045-0540	Manual Load Adapter T3

Manual Load Adapter T4

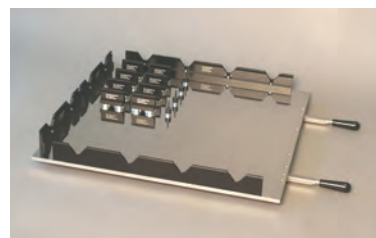

Description
Adapter to turn T4 conveyor into a manual load table. Maximum board size: 554 x 443 mm (21.8" x 17.4"). Includes board edge support and support pins for the board thickness range 0.5 - 4 mm.

Requirements:
T4 conveyor

Part no.	Product name
L-045-0539	Manual Load Adapter T4

Manual Load Adapter T5

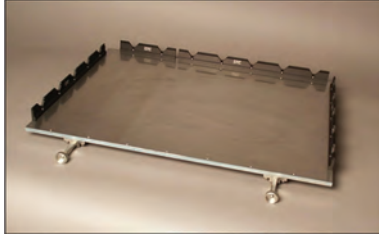

Description

Adapter to convert a T5 conveyor into a manual load table.
Maximum board size: 725 x 556 mm (28" x 22"). Includes board edge support and support pins for the board thickness ranges 0.5 - 4 mm and 3 - 8 mm.

Part no.	Product name
L-045-0485	Manual Load Adapter T5

Manual Load Adapter T6

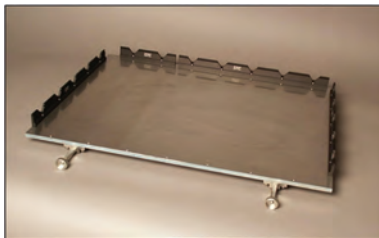

Description

Adapter to convert a T6 conveyor into a manual load table.
Maximum board size: 905 x 556 mm (35,4" x 22"). Includes board edge support and support pins for the board thickness ranges 0.5 - 4 mm and 3 - 8 mm.

Part no.	Product name
L-045-0486	Manual Load Adapter T6

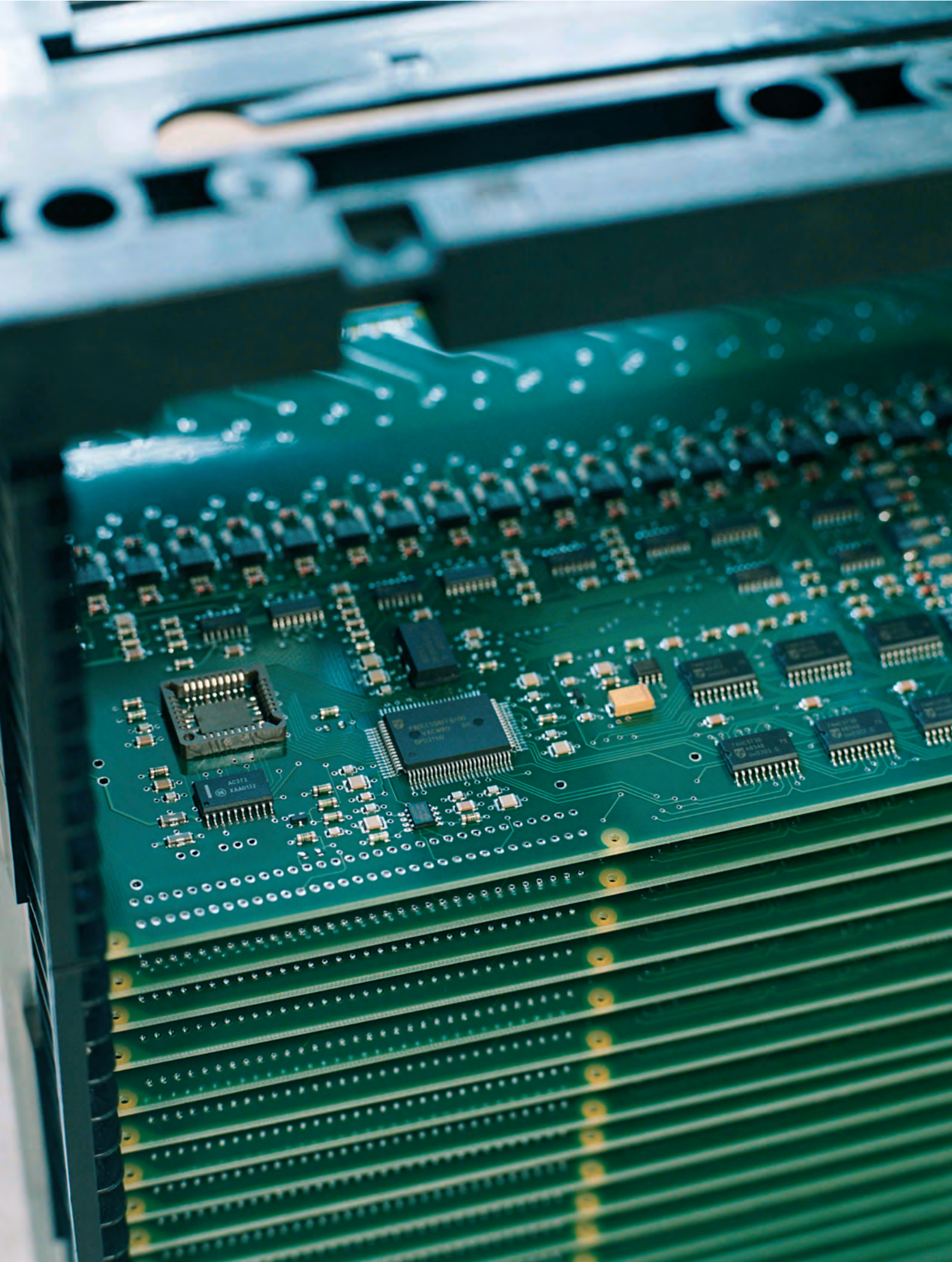

Inline System

Automation. Integration. These two factors are closely related in any facility. When it comes to boosting production output, in-line solutions are a crucial factor in the equation. That's why MYDATA's machines have a modular design with external conveyors so that you can easily create a multitude of smart, versatile solutions.

Integrating fully modular T and PT solutions in combination with external conveyor units can create the inline solution for virtually any application. In addition, the Y-module can be positioned in one of several slots, and all MYDATA machines are compatible with our wide range of board-handling systems.

What level of automation are you planning to use? We provide a versatile selection of external board-handling equipment such as transport buffer conveyors, telescopic gates, loaders and unloaders, turn units and workstations that fully integrate with your production process. In short, we offer all the external units you need to build your system just the way you want it. And when it comes to specialized board-handling requirements, we also offer customized solutions for virtually any application. All you have to do is ask!

MYDATA also offers a wide selection of loaders and unloaders to suit the varying automation levels and batch sizes running in your line. Choose from de-stackers that load boards onto the line; or more advanced, automated loaders that hold many cassettes filled with boards. In addition we offer a wide range of cassettes that are compatible with our loaders and unloaders, depending on board type and size.

T3 Conveyor Package MY9

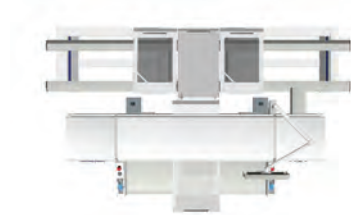

Description

Conveyor package for one MY9 machine with T3 conveyor. The package include two T3 Conveyor 1500 (K-017-0519) and two Safety Cover + Loop T3/T4 (K-017-0532).

Part no.	Product name
K-017-0526	T3 Conveyor Package MY9

T3 Conveyor Package MY12/MY15

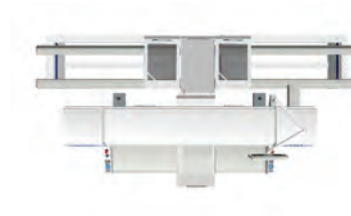

Description

Conveyor package for one MY12 or one MY15 machine with T3 conveyor. The package include two T3 Conveyor 2000 (K-017-0520) and two Safety Cover + Loop T3/T4 (K-017-0532).

Part no.	Product name
K-017-0527	T3 Conveyor Package MY12/MY15

T3 Conveyor Package MY19



Description

Conveyor package for one MY19 machine with T3 conveyor. The package include two T3 Conveyor 2500 (K-017-0521) and two Safety Cover + Loop T3/T4 (K-017-0532).

Part no.	Product name
K-017-0528	T3 Conveyor Package MY19

T4 Conveyor Package MY12/MY15

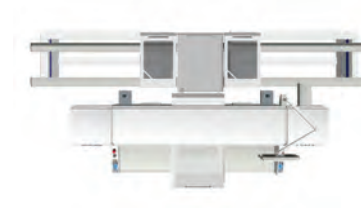

Description

Conveyor package for one MY12 or one MY15 machine with T4 conveyor. The package include two T4 Conveyor 2000 (K-017-0524) and two Safety Cover + Loop T3/T4 (K-017-0532).

Part no.	Product name
K-017-0529	T4 Conveyor Package MY12/MY15

T4 Conveyor Package MY19

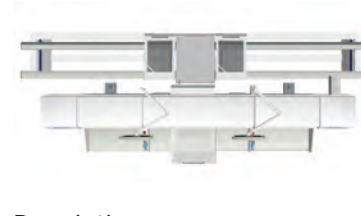

Description

Conveyor package for one MY19 machine with T4 conveyor. The package include two T4 Conveyor 2500 (K-017-0525) and two Safety Cover + Loop T3/T4 (K-017-0532).

Part no.	Product name
K-017-0530	T4 Conveyor Package MY19

T3 MYSynergy Package MY9/MY9

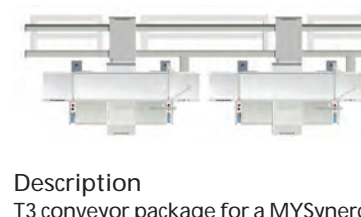

Description

T3 conveyor package for a MYSynergy line with two MY9 machines. The package include two T3 Conveyor 1500 (K-017-0519), one T3 Conveyor 2500 (K-017-0521) and Safety Cover + Loop (K-017-0532). The line configuration is made as short as possible.

Part no.	Product name
K-017-0555	T3 MYSynergy Package MY9/MY9

T3 MYSynergy Package MY9/MY12



Description
T3 conveyor package for a MYSynergy line with one MY9 and one MY12 machine. The package include four T3 Conveyor 1500 (K-017-0519) and Safety Cover + Loop (K-017-0532). The line configuration is made as short as possible and the MY9 has to be first according to the picture.

Part no.	Product name
K-017-0556	T3 MYSynergy Package MY9/MY12

T3 MYSynergy Package MY12/MY12



Description
T3 conveyor package for a MYSynergy line with two MY12 machine. The package include three T3 Conveyor 1500 (K-017-0519), one T3 conveyor 2000 (K-017-0520) and Safety Cover + Loop (K-017-0532). The line configuration is made as short as possible.

Part no.	Product name
K-017-0557	T3 MYSynergy Package MY12/MY12

Transport Conveyor Package Light for MY9



Description
Light conveyor package for MY9 machines in T-configuration. The package include two Transport Conveyors Light 1500 (K-017-0447) and two Safety Covers ESD + Safety Loop (K-017-0161)

Part no.	Product name
K-017-0452	Transport Conveyor Package Light for MY9

Transport Conveyor Package Light for MY12/15



Description
Light conveyor package for one MY12 or MY15 machine in T-configuration. The package include two Transport Conveyors Light 2000 (K-017-0448) and two Safety Covers ESD + Safety Loop (K-017-0161)

Part no.	Product name
K-017-0453	Transport Conveyor Package Light for MY12/15

TRP/BU Conv Package T5/T6 MY15



Description
Conveyor package for one MY15 machine with T5/T6 conveyor. The package include two Transport-Buffer Conveyor T5/T6 2000 (K-017-0273) with motorized width.

Part no.	Product name
K-017-0491	TRP/BU Conv Package T5/T6 MY15

TRP/BU Conv Package T5/T6 MY19



Description

Conveyor package for one MY19 machine with T5/T6 conveyor. The package include two Transport-Buffer Conveyor T5/T6 2500 (K-017-0274) with motorized width.

Part no.	Product name
K-017-0492	TRP/BU Conv Package T5/T6 MY19

TRP/BU Conv Package T5/T6 MY12/MY15



Description

Conveyor package for one MY12 or MY15 machine with T5/T6 conveyor. The package include two Transport-Buffer Conveyor T5/T6 1500 (K-017-0272) with motorized width.

Part no.	Product name
K-017-0493	TRP/BU Conv Package T5/T6 MY12/MY15

Transport Conveyor Package Light for MY19

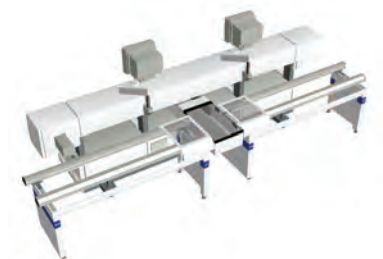

Description

Light conveyor package for one MY19 500T-configuration. The package include two Transport Conveyors Light 2500 (K-017-0449) and two Safety Covers ESD + Safety Loop (K-017-0161)

Part no.	Product name
K-017-0454	Transport Conveyor Package Light for MY19

T3 Conveyor



Description

The T3 conveyor is a sectioned conveyor with a rigid framework. Each side and section of the conveyor has its own motor, belt and board-present sensor, enabling a board to be buffered on each section and provide smooth, reliable transportation of PCBs.

Communication with preceding and following units is done via the standard SMEMA interface, which makes the conveyor easy to install in an electronics assembly line. The board train function with controlled high speed transportation and automatic width adjustment are two optional features that increase throughput and reduce the need for manual interventions, i.e. features that are eligible especially in high-mix / high-volume production.

Conveyor width adjustment is motorized as standard. Motors and cables are housed in the conveyor profile, giving a clean outlook to the unit. The conveyor frame is used for housing connectors, PLC and associated control electronics.

Board transport level: 935 +/- 35 mm (36.8" +/-1.4")
 Buffering zone length: 500 mm (19.7")
 Board length: 70 - 470 mm (2.8" - 18.5")
 Board width: 50 - 508 mm (2" - 20")
 Board thickness: 0.4 - 6 mm (0.016" - 0.24")
 Board edge clearance: 3 mm (0.12")
 Maximum warpage: 0.5%
 Voltage: 100 - 240 VAC 50/60 Hz.
 SMEMA Interface

Part no.	Product name
K-017-0516	T3 Conveyor 500
K-017-0517	T3/T4 Conveyor 700
K-017-0518	T3 Conveyor 1000

Part no.	Product name
K-017-0519	T3 Conveyor 1500
K-017-0520	T3 Conveyor 2000
K-017-0521	T3 Conveyor 2500

T4 Conveyor



Description

The T4 conveyor is a sectioned conveyor with a rigid framework. Each side and section of the conveyor has its own motor, belt and board-present sensor, enabling a board to be buffered on each section and provide smooth, reliable transportation of PCBs.

Communication with preceding and following units is done via the standard SMEMA interface, which makes the conveyor easy to install in an electronics assembly line. The board train function with controlled high speed transportation and automatic width adjustment are two optional features that increase throughput and reduce the need for manual interventions, i.e. features that are eligible especially in high-mix / high-volume production.

Conveyor width adjustment is motorized as standard. Motors and cables are housed in the conveyor profile, giving a clean outlook to the unit. The conveyor frame is used for housing connectors, PLC and associated control electronics.

Board transport level: 935 +/- 35 mm (36.8" +/-1.4")
 Buffering zone length: 1000 mm (39.4")
 Buffering zones: 1 or 2 depending on conveyor length
 Board length: 70 - 575 mm (2.8" - 22.6")
 Board width: 50 - 508 mm (2" - 20")
 Board thickness: 0.4 - 6 mm (0.016" - 0.24")
 Board edge clearance: 3 mm (0.12")
 Maximum warpage: 0.5%
 Voltage: 100 - 240 VAC 50/60 Hz.
 SMEMA Interface

Part no.	Product name
K-017-0522	T4 Conveyor 1000
K-017-0523	T4 conveyor 1500
K-017-0524	T4 conveyor 2000

T4 Conveyor 2500



Description

The T4 conveyor is a sectioned conveyor with a rigid framework. Each side and section of the conveyor has its own motor, belt and board-present sensor, enabling a board to be buffered on each section and provide smooth, reliable transportation of PCBs.

Communication with preceding and following units is done via the standard SMEMA interface, which makes the conveyor easy to install in an electronics assembly line. The board train function with controlled high speed transportation and automatic width adjustment are two optional features that increase throughput and reduce the need for manual interventions, i.e. features that are eligible especially in high-mix / high-volume production.

Conveyor width adjustment is motorized as standard. Motors and cables are housed in the conveyor profile, giving a clean outlook to the unit. The conveyor frame is used for housing connectors, PLC and associated control electronics.

Board transport level: 935 +/- 35 mm (36.8" +/-1.4")
 Buffering zone length: 1000 mm (39.4")
 Buffering zones: 1 or 2 depending on conveyor length
 Board length: 70 - 575 mm (2.8" - 22.6")
 Board width: 50 - 508 mm (2" - 20")
 Board thickness: 0.4 - 6 mm (0.016" - 0.24")
 Board edge clearance: 3 mm (0.12")
 Maximum warpage: 0.5%
 Voltage: 100 - 240 VAC 50/60 Hz.
 SMEMA Interface

Part no.	Product name
K-017-0525	T4 Conveyor 2500

Single Loader



Description

The Single Loader separates and loads bare or mounted PCBs and solder frames from rasterized magazines onto a subsequent production line. The Single Loader holds 1 magazine.

The filling ratio, skip factor, and first and last load/unload positions of the magazine are all selectable. Most standard size magazines are supported, and multiple magazine settings can be stored in memory for easy retrieval when changing between different sized magazines.

All input is through the operating panel, which makes the unit easy to use. When necessary the tri-coloured light tower, with its audible alarm, attracts the operator's attention and an informative message is displayed on the operating panel.

- Max. magazine length: 535 mm (21")
- Max. magazine depth: 580 mm (22.8")
- Max. Magazine height: 570 mm (22.4")
- Max magazine weight: 40 kg (88 lbs)
- Air pressure: 6 bar (600 kPa)
- Voltage: 100-240 VAC, 50/60 Hz

Part no.	Product name
K-017-0590	Single Loader

Single Unloader



Description

The Single Unloader unloads the production line and loads bare or mounted PCBs and solder frames into rasterized magazines. The Single Unloader holds up to 3 magazines simultaneously.

The filling ratio, skip factor, and first and last load/unload positions of the magazine are all selectable. Most standard size magazines are supported, and multiple magazine settings can be stored in memory for easy retrieval when changing between different sized magazines.

All input is through the operating panel, which makes the unit easy to use. When necessary the tri-coloured light tower, with its audible alarm, attracts the operator's attention and an informative message is displayed on the operating panel.

- Max. magazine length: 535 mm (21")
- Max. magazine depth: 580 mm (22.8")
- Max. Magazine height: 570 mm (22.4")
- Max magazine weight: 40 kg (88 lbs)
- Air pressure: 6 bar (600 kPa)
- Voltage: 100-240 VAC, 50/60 Hz

Part no.	Product name
K-017-0591	Single Unloader

Automatic Loader



Description

The loader separates and loads bare or mounted PCBs and solder frames from rasterized magazines onto a subsequent production line. The Automatic Loader holds up to 3 magazines simultaneously.

The filling ratio, skip factor, and first and last load/unload positions of the magazine are all selectable. Most standard size magazines are supported, and multiple magazine settings can be stored in memory for easy retrieval when changing between different sized magazines.

All input is through the operating panel, which makes the unit easy to use. When necessary the tri-coloured light tower, with its audible alarm, attracts the operator's attention and an informative message is displayed on the operating panel.

Max. magazine length: 535 mm (21")
 Max. magazine depth: 580 mm (22.8")
 Max. Magazine height: 570 mm (22.4")
 Max magazine weight: 40 kg (88 lbs)
 Air pressure: 6 bar (600 kPa)
 Power supply: 100-240 VAC, 50/60 Hz

Part no.	Product name
K-017-0561	Automatic Loader

Automatic Unloader



Description

The Automatic Unloader unloads the production line and loads bare or mounted PCBs and solder frames into rasterized magazines. The Automatic Unloader holds up to 3 magazines simultaneously.

The filling ratio, skip factor, and first and last load/unload positions of the magazine are all selectable. Most standard size magazines are supported, and multiple magazine settings can be stored in memory for easy retrieval when changing between different sized magazines.

All input is through the operating panel, which makes the unit easy to use. When necessary the tri-coloured light tower, with its audible alarm, attracts the operator's attention and an informative message is displayed on the operating panel.

Max. magazine length: 535 mm (21")
 Max. magazine depth: 580 mm (22.8")
 Max. Magazine height: 570 mm (22.4")
 Max magazine weight: 40 kg (88 lbs)
 Air pressure: 6 bar (600 kPa)
 Voltage: 100-240 VAC, 50/60 Hz

Part no.	Product name
K-017-0562	Automatic Unloader

Automatic Reloader



Description

The Automatic Reloader loads bare or mounted boards from magazines onto the conveyor in the production line, waits for the board to return, and receives the processed board back into its original magazine slot. Most standard size magazines are supported. All inputs are through the operating panel which makes the unit easy to use. Magazines are not included. The Automatic Reloader can hold up to 3 magazines.

Max magazine length: 535 mm (21")
 Max magazine width: 580 mm (22.8")
 Max magazine height: 570 mm (22.5")
 Max magazine weight: 40 kg (55 lbs)
 Power supply: 100-240V AC 50/60 Hz
 Air pressure: 6 bar (600 kPa)
 SMEMA Interface

Part no.	Product name
K-017-0563	Automatic Reloader

Board Destacker



Description

The destacker separates a of boards from the bottom of the stack and transports them one by one onto the production line. If the unit becomes empty, or the destacking switch is turned off, the conveyor starts to work as a regular transport conveyor, which means that the destacker can be placed inline without any modifications. Conveyor width adjustment is manual, and is carried out with a handwheel. Indicator light for low stack height and empty stack is standard.

Length: 0.5m (19.7")
 Board length: 80-440 mm (3.1-17.3")
 Board width: 50-490 mm (2.0-19.3")
 Board thickness: 0.8-2.5 mm (0.03-0.1")
 Electricity required: 90-240 VAC 50/60 Hz
 Required air pressure: 6 bar (600 kPa)

Part no.	Product name
L-017-0048	Board Destacker

Manual Loader Light



Description

The manual light loader separates and loads boards from one magazine onto the conveyor in the production line. The Loader supports all standard magazines. Filling ratio, skip factor, first and last unloading/ loading position of the magazine are all selectable. All input is made through the flat operation panel which makes

the unit easily managed. Light tower and magazines are not included.

Max magazine length: 535 mm (21")
 Max magazine width: 580 mm (22.8")
 Max magazine height: 570 mm (22.5")
 Max magazine weight: 25 kg (55 lbs)
 Electricity required: 100-240V AC 50/60 Hz
 Required air pressure: 6 bar (600 kPa)
 SMEMA Interface

Part no.	Product name
K-017-0450	Manual Loader Light

Manual Unloader Light

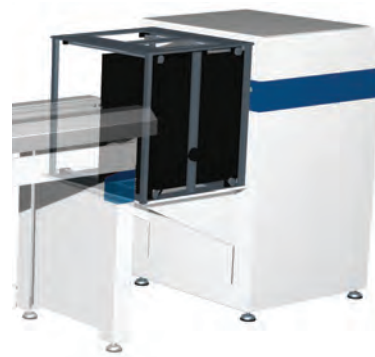

Description

The light unloader unloads boards from the production line onto the magazine. Most standard sized magazines are supported. Filling ratio, skip factor, first and last unload/load position of the magazine is selectable. All inputs are made through the operational panel which makes the unit easily managed. Light tower and magazines are not included.

Max magazine length: 535 mm (21")
 Max magazine width: 580 mm (22.8")
 Max magazine height: 570 mm (22.5")
 Max magazine weight: 25 kg (55 lbs)
 Electricity required: 100-240V AC 50/60 Hz
 Required air pressure: 6 bar (600 kPa)
 SMEMA Interface

Part no.	Product name
K-017-0451	Manual Unloader Light

Manual Reloader Light



Description

The reloader loads bare or pre-inserted boards from the magazines onto the conveyor in the production line. Waits for the board to return, and receives the processed board back into the original magazine slot. Most standard sized magazines are supported. All inputs are made through the operational panel which makes the unit easily managed. Light tower and magazines are not included.

Max magazine length: 535 mm (21")
 Max magazine width: 580 mm (22.8")
 Max magazine height: 570 mm (22.5")
 Max magazine weight: 25 kg (55 lbs)
 Electricity required: 100-240V AC 50/60 Hz
 Required air pressure: 6 bar (600 kPa)
 SMEMA Interface

Part no.	Product name
K-017-0457	Manual Reloader Light

Board Inverter



Description

The Board Inverter turns the board upside down to make mounting possible on the secondary side without manual intervention. Conveyor width adjustment is motorised and is carried out manually by a switch. The unit is also equipped with a pass through switch,

that disables the inversion function, allowing the boards to pass through the unit without being handled.

Board length: 50 - 470 mm (2" - 18.5")
 Board width: 50 - 508 mm (2" - 20")
 Board thickness: 0.8 - 4 mm (0.03" - 0.2")
 Board edge clearance: 3 mm (0.12")
 Electricity required: 100 - 240V AC 50/60 Hz.
 SMEMA Interface

Part no.	Product name
K-017-0189	Board Inverter

Board Transfer System



Description

The board transfer system is the solution for dividing or merging production lines and to transferring boards between them. The system consists of two in/out feed units, a traverse unit and a board carrying shuttle conveyor. The shuttle moves the width of the traverse unit and the movement is pneumatic. Each side of shuttle conveyor has its own motor drives and belts which gives a reliable transport of heavy boards. Conveyor width adjustment is motorised and it is carried out. Motorised width adjustment with a toggle switch. Customer defined in/out combinations.

Shuttle conveyor length: 0.5m (19.7")
 Board length: 50 - 470 mm (2" - 18.5")
 Board width: 50 - 508 mm (2" - 20")
 Board thickness: 0.8 - 4 mm (0.03" - 0.2")
 Board edge clearance: 3 mm (0.12")
 Electricity required: 100 - 240V AC 50/60 Hz.
 SMEMA Interface

Part no.	Product name
K-017-0187	Board Transfer System

FIFO/LIFO Buffer Unit



Description

The buffer unit is designed to balance station capacity differences and offer board escape possibilities in case of failures of the connected systems. The FIFO/LIFO capability and the ability to disable board buffering gives the unit a wide range of uses. Conveyor width adjustment is motorised and is carried out manually by a toggle switch.

Board length: 50 - 470 mm (2" - 18.5")
 Board width: 50 - 508 mm (2" - 20")
 Board thickness: 0.8 - 4 mm (0.03" - 0.2")
 Board edge clearance: 3 mm (0.12")
 Electricity required: 100 - 240V AC 50/60 Hz.
 SMEMA Interface

Part no.	Product name
K-017-0188	FIFO/LIFO Buffer Unit

Manual Gate Conveyor



Description

The Manual Gate Conveyor allows people to pass through complete line. The section that can be lifted is a non-buffering section to keep it empty thereby allow people to pass through even if the line has a heavy board flow. The section is also supplied with a counterweight and shock absorber to ensure smooth movement. The motorised width adjustment is on both sections operated manually by a toggle switch.

Board length: 50 - 470 mm (2" - 18.5")
 Board width: 50 - 508 mm (2" - 20")
 Board thickness: 0.8 - 4 mm (0.03" - 0.2")
 Board edge clearance: 3 mm (0.12")
 Electricity required: 100 - 240V AC 50/60 Hz.
 SMEMA Interface

Part no.	Product name
K-017-0186	Manual Gate Conveyor

Telescopic Gate 1650



Description

The telescopic gate conveyor is a fully automated pass through conveyor that allows people to pass through a production line. The retracted position of the telescopic conveyor is the idle position so there is no need to press a buttons to pass through the line. The opening is 700 mm. The telescopic conveyor is mounted on rails and movement is executed by two friction-clutched DC motors which gives a smooth, safe and stable extraction. Each side and section of the conveyor has its own motor drives and belts. Conveyor width adjustment is motorised and is carried out manually by a toggle switch. The gate has IR light grid and time comparison for highest safety.

Conveyor length: 1650 mm(65")
 Conveyor opening: 700 mm (27.5")
 Board length: 80-480 mm(3.1-18.9")
 Board width: 90-508 mm (3.5-20")
 Max. board weight: 3.0 kg (6.6 lbs)
 Electricity required: 90-240 VAC 50/60 Hz

Part no.	Product name
K-017-0185	Telescopic Gate 1650

Overhead Conveyor 1000



Description
 The overhead conveyor is a fully automated walk through conveyor. The unit can also be configured to pass the PCBs through, which in this case means that the board route is divided in the first tower, allowing for inspection in the lower conveyor. All these functions combined gives the unit a wide range of uses. The system consists of two elevators and a bridging section which transports boards between the two elevators. Workstation can be ordered separately.

Board length: 50 - 470 mm (2" - 18.5")
 Board width: 50 - 508 mm (2" -20")
 Board thickness: 0.8 - 4 mm (0.03" - 0.2")
 Board edge clearance: 3 mm (0.12")
 Electricity required: 100 - 240V AC 50/60 Hz.
 SMEMA Interface

Part no.	Product name
K-017-0190	Overhead Conveyor 1000

Turn Unit



Description
 The Turn Unit transfers boards through 90 bends, T-junctions or crossovers. Operation mode is easy to change without any software or hardware modification. The conveyor moves to an inlet position to collect a board. Conveyor width adjustment is motorised and it is carried out manually by a toggle switch. The unit is extremely compact and can be placed next to adjacent machines without the need for any interconnecting conveyors.

Board length: 50 - 450 mm (2-17.7")
 Board width: 50 - 508 mm (2" -20").
 Board thickness: 0.8 - 4 mm (0.03" - 0.2")
 Board edge clearance: 3 mm(0.12")
 Electricity required: 90 - 240V AC 50/60 Hz
 SMEMA Interface

Part no.	Product name
K-017-0184	Turn Unit

Transport-Buffer Narrow 400PT



Description
 Conveyor unit for interfacing at the front of a MYDATA machine in the Pass Through configuration. The conveyor is narrower than normal to allow magazine access on both sides.

Part no.	Product name
K-017-0200	Transport-Buffer Narrow 400PT 1000

Part no.	Product name
K-017-0270	Transport-Buffer Narrow 400PT 1500

Transport-Buffer Conveyor T5/T6



Description

This large board conveyor works as a regular conveyor but with reinforced rail structure, rail suspension and belt driving mechanism. Conveyor width adjustment is motorized as standard. Each section has motor drivers and belts that enables boards to be buffered on each segment, providing a smooth and reliable board transportation. The conveyor frame is manufactured from welded steel which makes the system rigid and solid.

Board length: 50 - 930 mm (2" - 36.6")
 Board width: 50 - 621 mm (2" - 24.5")
 Board thickness: 1.0 - 12.7 mm (0.04" - 0.5")
 Board edge clearance: 4 mm (0.12")
 Electricity required: 100 - 240V AC 50/60 Hz.
 SMEMA Interface

Part no.	Product name
K-017-0271	Transport-Buffer Conveyor T5/T6 1000
K-017-0272	Transport-Buffer Conveyor T5/T6 1500
K-017-0273	Transport-Buffer Conveyor T5/T6 2000
K-017-0274	Transport-Buffer Conveyor T5/T6 2500

Transport Conveyor Light



Description

The Transport Conveyor lights are cost effective units with low maintenance. They provide safe board transportation without advanced functions or optional accessories. Conveyor width is manual and carried out quickly in a few steps. The conveyor frame

is manufactured from welded steel which makes the system rigid and solid.

Board length: 50 - 470 mm (2" - 18.5")
 Board width: 50 - 508 mm (2" - 20")
 Board thickness: 0.8 - 4 mm (0.03" - 0.2")
 Max board weight: 2 kg (4.4 lbs)
 Board edge clearance: 3 mm (0.12")
 Electricity required: 100 - 240V AC 50/60 Hz.
 SMEMA Interface

Part no.	Product name
K-017-0445	Transport Conveyor Light 500
K-017-0446	Transport Conveyor Light 1000
K-017-0447	Transport Conveyor Light 1500
K-017-0448	Transport Conveyor Light 2000
K-017-0449	Transport Conveyor Light 2500

Reloader Conveyor



Description

The reloader conveyor is two-way transport conveyor that automatically changes transport direction according to standard communication signals received from the adjacent machine. It can be used with the light reloader (K-017-0457), or as a manual load and unload conveyor with a MYDATA machine.

Part no.	Product name
K-017-0477	Reloader Conveyor Light 500
K-017-0478	Reloader Conveyor Light 1000

Workstation T3



Description

The T3 workstation is built around the standard T3 conveyor and enables manual assembly work and inspections to be carried out on PCBs in-line. Each side and section of the conveyor has its own motor and belt, providing smooth and reliable transportation of PCBs.

Communication with preceding and following units is done via the standard SMEMA interface, which makes the conveyor easy to install in an electronics assembly line.

Width adjustment is motorized as standard. Motors and cables are housed in the conveyor profile, giving a clean outlook to the unit. The conveyor frame is used for housing connectors, PLC and associated control electronics.

The workstation includes programmable board stop counter, board release hand switch, pass through/inspect switch, earth strap connection. The conveyor also includes an armrest and framework prepared for lights, shelves and accessories.

Board transport level: 935 +/- 35 mm (36.8" +/-1.4")
 Buffering zones: 1000 mm = 1, 1500 mm =2
 Board length: 70 - 470 mm (2.8" - 18.5")
 Board width: 50 - 508 mm (2" - 20")
 Board thickness: 0.4 - 6 mm (0.016" - 0.24")
 Board edge clearance: 3 mm (0.12")
 Maximum warpage: 0.5%
 Voltage: 100 - 240 VAC 50/60 Hz.
 SMEMA Interface

Part no.	Product name
K-017-0533	Workstation 1000 T3
K-017-0535	Workstation 1500 T3

Workstation T4



Description

The T4 workstation is built around the standard T4 conveyor and enables manual assembly work and inspections to be carried out on PCBs in-line. Each side and section of the conveyor has its own motor and belt, providing smooth and reliable transportation of PCBs.

Communication with preceding and following units is done via the standard SMEMA interface, which makes the conveyor easy to install in an electronics assembly line.

Width adjustment is motorized as standard. Motors and cables are housed in the conveyor profile, giving a clean outlook to the unit. The conveyor frame is used for housing connectors, PLC and associated control electronics.

The workstation includes programmable board stop counter, board release hand switch, pass through/inspect switch, earth strap connection. The conveyor also includes an armrest and framework prepared for lights, shelves and accessories.

Board transport level: 935 +/- 35 mm (36.8" +/-1.4")
 Buffering zones: 1
 Board length: 70 - 575 mm (2.8" - 22.6")
 Board width: 50 - 508 mm (2" - 20")
 Board thickness: 0.4 - 6 mm (0.016" - 0.24")
 Board edge clearance: 3 mm (0.12")
 Maximum warpage: 0.5%
 Voltage: 100 - 240 VAC 50/60 Hz.
 SMEMA Interface

Part no.	Product name
K-017-0534	Workstation 1000 T4
K-017-0536	Workstation 1500 T4

Motorised Width Adjustment Option

Description

Conveyor option for motorised width instead of the standard manual wheel adjustment. This option is standard on the T3, T4 and T5/T6 conveyors.

Part no.	Product name
K-017-0124	Motorised Width Adjustment Option

Adjustable Conveyor Speed Option

Description
Option for Transport-Buffer Conveyor to allow the transport speed to be adjusted on one conveyor segment, for example when a conveyor is placed ahead of a reflow unit.

Part no.	Product name
K-017-0127	Adjustable Conveyor Speed Option

Safety Cover + Safety Loop T3/T4

Description
Safety cover (ESD) option for a conveyor units next to MYDATA machines or other equipment. Including safety loop to make the conveyor stop when a safety cover is opened.

Part no.	Product name
K-017-0532	Safety Cover + Safety Loop T3/T4

Inspection Option

Description
Option for Transport-Buffer Conveyor to allow PCB inspection on a regular conveyor. The kit includes a switch with three positions, PASS, INSPECT and RELEASE. The conveyor works as a normal when placed in the PASS mode. When positioned in the INSPECT mode each board is stopped and separately released after inspection using the same switch. The Inspection Kit can be mounted on any new conveyors and length.

Ordering info:
Specify which segment to have the inspection

Part no.	Product name
K-017-0285	Inspection Option

End of Line Conveyor Option

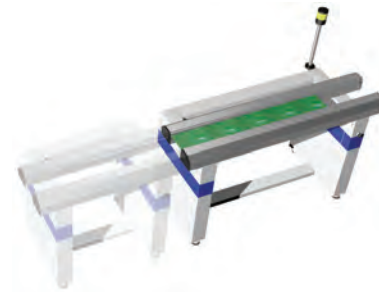

Description
Option for a conveyor placed at the end of a production line. The conveyor buffers boards and signals when the conveyor is full. Includes lightsignal and buzzer. Min length 1000 conv.

Part no.	Product name
K-017-0455	End of Line Conveyor Option

Start of Line Conveyor Option

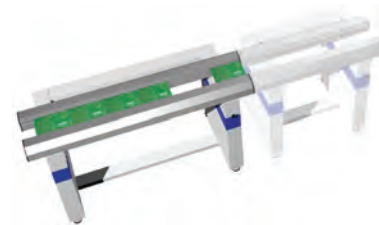

Description
Option for a conveyor placed at the beginning of a production line. The conveyor works as a loader as boards are transported onto the production line. Includes release button. Min length 1500 conv.

Part no.	Product name
K-017-0456	Start of Line Conveyor Option

Conveyor Floor Braces



Description
Set of two braces to connect external conveyor units to the floor.

Part no.	Product name
K-017-0476	Conveyor Floor Braces

Auto Width Inline Option

Description
Conveyor option for automatic width adjustment. The width is set on the first unit in the line and the other will follow. One unit is required for each unit in the line that requires auto width. Includes motorized width adjustment. No upgrades available.

Ordering info:
One unit is required per conveyor or other inline equipment. Contact MYDATA sales representative for more information.

Part no.	Product name
K-017-0487	Auto Width Inline Option

Auto Width Control Unit Option



Description
Optional panel for setting the pcb width on the master (first auto width unit) in the production line. The pcb width is easily programmed on the digital display using buttons then when the conveyor is empty, the new pcb width will be automatically adjusted. Contact MYDATA sales representative for more information.

Requirements:
K-017-0487

Part no.	Product name
K-017-0488	Auto Width Control Unit Option

Light Tower Option



Description
Light tower option for light loaders, unloaders and reloader.

Part no.	Product name
K-017-0472	Light Tower Option

SMEMA Machine Ready Detection Option

Description
Optional extra sensor used when a unit after a loader does not have SMEMA standard communication.

Part no.	Product name
K-017-0474	SMEMA Machine Ready Detection Option

SMEMA Board Available Detection Option

Description
Optional extra sensor used when a unit before an unloader or a conveyor or other external conveyor unit does not have SMEMA standard communication.

Part no.	Product name
K-017-0475	SMEMA Board Available Detection Option

Additional Magazine Conveyor Unit

Description
The Additional Magazine Conveyor Unit fits on the Automatic Loader, Unloader and Reloader (K-017-0561, -0562, -0563).

The Additional Magazine Conveyor Unit allows the Loader/Unloader/Reloader to handle 2 additional PCB magazines, totally 5 PCB magazines, two on the inlet, one in the machine and two on the outlet.

Machine type:
Unloader , Loader

Part no.	Product name
K-017-0598	Additional Magazine Conveyor Unit

C-Profiled Stand 1500



Description
Option for Manual Workstation to provide support for overhead lighting. Choose the correct length for your workstation.

Part no.	Product name
K-017-0130	C-Profiled Stand 1500

C-Profiled Stand 1000

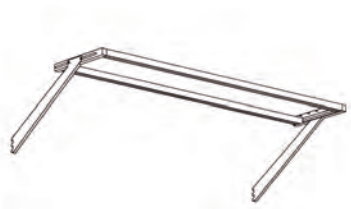

Description
Option for Manual Workstation to provide support for overhead lighting. Choose the correct length for your workstation.

Part no.	Product name
K-017-0131	C-Profiled Stand 1000

Plastic ESD Storage Box



Description
Option for Manual Workstation. ESD safe boxes for practical for storage of small items. Requires suspension rail and framework.

Part no.	Product name
K-017-0136	Plastic ESD Storage Box

Power Rail 220 100/1500

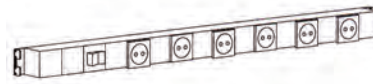

Description
Option for Manual Workstation 1000 and 1500. Includes six socket connections and requires suspension rail.

Part no.	Product name
K-017-0141	Power Rail 220 100/1500

Foot Rest



Description
Option for Manual Workstation. Provides a comfortable foot support with adjustable angle.

Part no.	Product name
K-017-0142	Foot Rest

Workstation Release Pedal

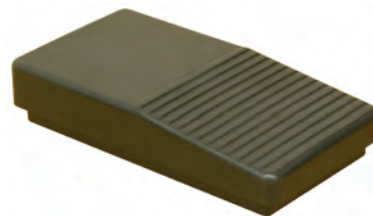

Description
Optional floor pedal instead of the standard release button on the conveyor. For example on a workstation, inspection unit or start of line conveyor.

Part no.	Product name
K-017-0498	Workstation Release Pedal

Board Train Function T5/T6

Description

Optional board train functionality for two T5/T6 external conveyors, one packing and one for unpacking of boards in the line. This option in combination with special MYDATA software, makes it possible to run board trains on the MYDATA machine and significantly improve the board transfer time and throughput.

Recommended minimum board size is 100 mm length and 1.6 mm thickness.

Part no.	Product name
K-017-0484	Board Train Function T5/T6

Board Train Function T3/T4

Description

Optional board train functionality for two T3 or T4 external conveyors, one packing and one for unpacking of boards in the line. This option in combination with special MYDATA software, makes it possible to run board trains on the MYDATA machine and significantly improve the board transfer time and throughput.

Recommended minimum board size is 100 mm length and 1.6 mm thickness.

Part no.	Product name
K-017-0531	Board Train Function T3/T4

Upgrade Kit Board Train T5/T6

Description

Upgrade to run board train functionality for two external buffer conveyors, one packing and one for unpacking of boards in the line. This option in combination with special MYDATA software, makes it possible to run board trains on the MYDATA machine and significantly improve the board transfer time and throughput. Only possible on newer versions of conveyors.

Recommended minimum board size is 100 mm length and 1.6 mm thickness.

Part no.	Product name
K-017-0481	Upgrade Kit Board Train T5/T6

Conveyor Slide Extension Option

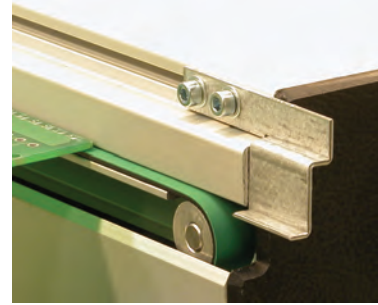

Description

Conveyor extension to minimize the gap between the conveyor and printer or reflow oven.

Part no.	Product name
K-017-0499	Conveyor Slide Extension Option

Adjustable Sensor Arm Upgrade



Description

Sensor arm for conveyors that can be adjusted for detect odd shaped boards. Standard on all new conveyors.

Part no.	Product name
K-017-0500	Adjustable Sensor Arm Upgrade

In-line Barcode Reader

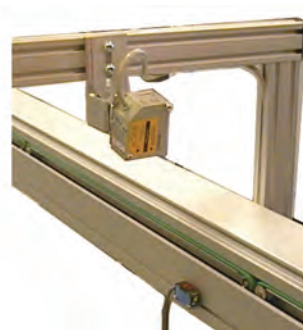

Description

The barcode reader on the external conveyor scans incoming PCBs and determines their identity. The data is then communicated to

TPSys which loads the appropriate assembly program. The external barcode reader on the conveyor increases the level of flexibility and automation in the production line. The process ensures the proper mounting of components regardless of the mix of PCBs on the conveyor line. TPSys can also filter out a PCB serial number and store this number in the Event Log for traceability.

Symbologies: CODE39, ITF, Industrial 2-of-5, COOP 2-of-5, Codabar, CODE 128, EAN/UPC (A-E). Maximum 32 characters.

This product includes a barcode reader, power supply and flexible mounting brackets. Barcode Software (0506) is not included. Line voltage 230V / 50Hz required.

Requirements:
Barcode Software (0506)

Ordering info:
Contact MYDATA sales representative for upgrades

Part no.	Product name
K-017-0191	Barcode Reader for Conveyor Option
K-017-0489	In-line Barcode Reader Light Conv
K-017-0490	In-line Barcode Reader T5/T6 Conv
K-017-0537	In-line Barcode Reader T3/T4 Conv

PCB Magazine Series 500



Description
The magazine is ESD safe plastic cassette design with pre-set slots that can be adjusted to handle many different board sizes. Fits all loaders and unloaders. Maximum board size:
PCB magazine 297 (L x W): 360 x 297 mm.
PCB Magazine 397 (L x W): 470 x 397 mm.

Part no.	Product name
K-017-0003	PCB Magazine 297
K-017-0004	PCB Magazine 397

PCB Magazine Series 700

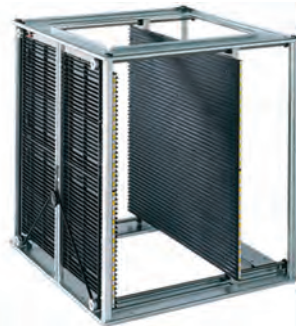

Description
Magazines for Loader and Unloader units. The magazines are ESD safe steel frame design and are easily adjusted to different PCB sizes using a gear belt on the side. The magazines have transport safety and are stackable, as well as reversible. Maximum PCB size:

PCB Magazine 310 (L x W) 387 x 310 mm.
PCB Magazine 390 (L x W): 522 x 390 mm.
PCB Magazine 460 (L x W): 522 x 460 mm.
PCB Magazine 510 (L x W): 522 x 510 mm.

Part no.	Product name
K-017-0486	PCB Magazine 310
K-017-0294	PCB Magazine 390
K-017-0295	PCB Magazine 460
K-017-0296	PCB Magazine 510

Auto Detection of PCBs in Magazine

Description
Scans the magazine in a Loader or Unloader at the beginning of its cycle to check the quantity and position of each PCB.

Requirements:
Installed units can not be upgraded with K-017-0596

Part no.	Product name
K-017-0596	Auto Detection of PCBs in Magazine

Auto Detection of PCB in Magazine

Description
Scans the magazine in a Loader or Unloader at the beginning of its cycle to check the quantity and position of each PCB. An additional feature ensures that each PCB is put in the same position in the Unloader's magazine.

Requirements:
Installed units cannot be upgraded with K-017-0597

Part no.	Product name
K-017-0597	Auto Detect and Communication Loader to Unloader

Description
 Standard accessorie package 2 for Workstation 1000 or 1500. Included in the package; Framework for accessories, C-profile stand with one Overhead light 1000 or 1500. Suspension rail with eight ESD safe boxes and one extensible shelf. One ergonomic foot rest.

Workstation Acc Package 1



Description
 Standard accessorie package 1 for Workstation 1000 or 1500. Included in the package; Framework for accessories, C-profile stand with one Overhead light 1000 or 1500. Suspension rail with eight ESD safe boxes. One ergonomic foot rest.

Part no.	Product name
K-017-0494	Workstation 1000 Acc Package 1
K-017-0496	Workstation 1500 Acc Package 1

Part no.	Product name
K-017-0495	Workstation 1000 Acc Package 2
K-017-0497	Workstation 1500 Acc Package 2

Workstation Framework



Description
 Option for Manual Workstation to provide support for shelves, suspension rails and storage boxes. Choose the correct length for your workstation.

Part no.	Product name
K-017-0128	Workstation Framework 1500
K-017-0129	Workstation Framework 1000

Workstation Acc Package 2



Overhead Lighting



Description
 1000 mm lighting for Manual Workstation. Includes 2 x 36 W low energy tubes.

Part no.	Product name
K-017-0132	Overhead Lighting 1000
K-017-0133	Overhead Lighting 500
K-017-0198	Overhead Lighting 1000, 110V
K-017-0284	Overhead Lighting 500 110V

Suspension Rail



Description
 Option for the Manual Workstation to support storage boxes.
 Choose the correct length for your workstation.

Part no.	Product name
K-017-0134	Suspension Rail 1500
K-017-0135	Suspension Rail 1000

Extensible Shelf

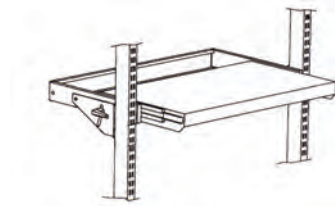

Description
 Option for Manual Workstation. The shelf can be pulled out to provide ergonomic and convenient space for tools and equipment.
 Choose the correct length for your workstation.

Part no.	Product name
K-017-0137	Extensible Shelf 1500
K-017-0138	Extensible Shelf 1000

Adjustable Shelf

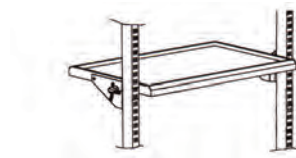

Description
 Option for a Manual Workstation. The shelf inclination is adjustable and has ESD safe ribbed rubber surface. Choose the correct length for your workstation.

Part no.	Product name
K-017-0139	Adjustable Shelf 1500
K-017-0140	Adjustable Shelf 1000

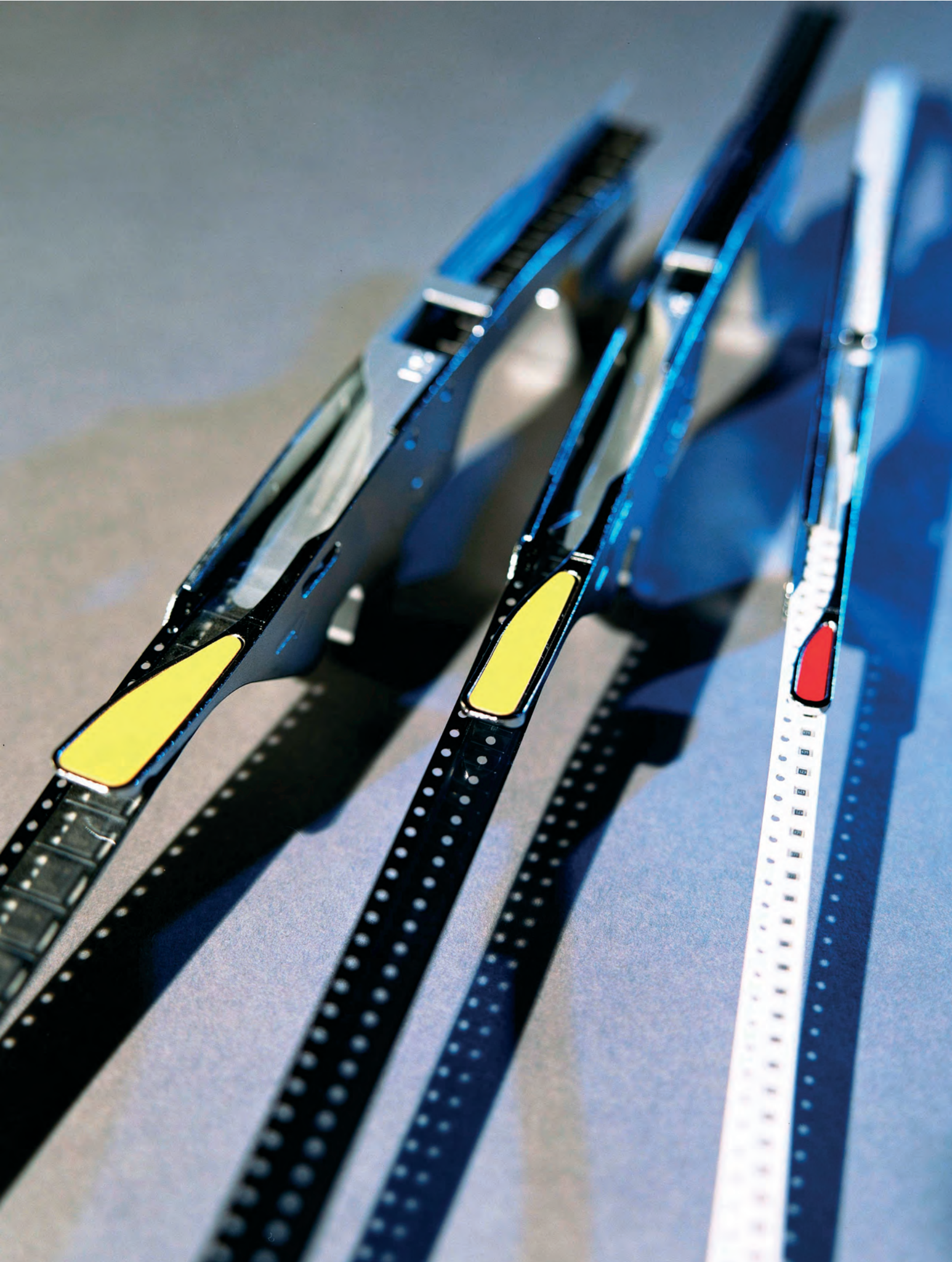

Feeder System

Whether you're looking for tape, stick or matrix tray feeders, MYDATA's feeders are designed to provide the utmost in reliability, performance and easy operation. And they all have one thing in common: intelligence.

While everyone today talks about intelligence, at MYDATA we call our feeders intelligent because all our magazines and feeders have their own unique identity. This enables the machine software, TPSys(R), to automatically recognize the presence, absence and location of components. The end result is that you never have to program pick positions and can easily replenish feeders while the machine is mounting. If a feeder runs out of components, production doesn't stop. Instead, the machine alerts the operator, re-optimizes and continues mounting other components.

Plus, with the dedicated barcode system, you can achieve higher levels of quality and intelligence. The system provides easy tracking of component and inventory data, such as batch ID numbers and quantity levels. And because barcode scanning eliminates manual entry during loading and unloading, setups and changeovers are even faster.

Whatever your production size, job setups and changeovers are a breeze with MYDATA's feeder systems. For instance, you can load our new Agilis(TM) tape feeders in less than 10 seconds. And all our feeder solutions facilitate multiple changes at once, cutting loading and unloading time to a minimum - whether you're working with tapes, sticks or trays.

Agilis LM8

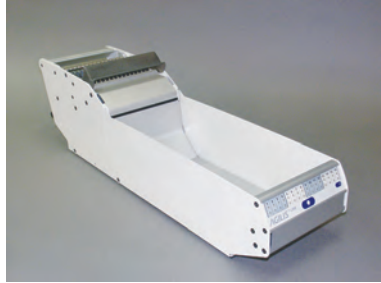

Description

The AGILIS Linear Magazine 8, Agilis LM8 holds up to 16 Agilis feeders for 8 mm component tape. Due to Agilis' unique feeder design, changeover and setup times can be significantly reduced. The magazine has a linear feeding mechanism that feeds the components into the machine with high accuracy and speed. The feeding pitch can be programmed to 2, 4 or 8 mm. When the magazine is inserted in the machine, each feeder is located and the pick positions are calculated. You can also fine-tune the pick positions with the joystick on the machine. An LED panel on the magazine shows the exact status of the feeders and reels. The magazine has a built-in service program and is low maintenance.

Two handy Agilis Bins for easy handling of 7" reels are included. Handles larger reels with Agilis bins for 13" reels or Agilis Large Reel Attachment.

Machine type:

TP9-1 , TP9-2 , TP9-3 , TP9-4 , TP11 , TP12 , TP18 , MY9 , MY12 , MY15 , MY19

Requirements:

Agilis Feeder 8, TPSys 2.4 or later, Magazine Control Unit including CAN, AT-CPU with 166 MHz processor or later. For machines with HYDRA: HYDRA 21K or HYDRA ATE (long HYDRA tools) Midas tool requirements: Tool A14S, Tool A23 rev. D or A23S rev. B, Tool A24 rev. D or A24S rev. B

Part no.	Product name
L-014-1561	Agilis LM8

Agilis LM1216

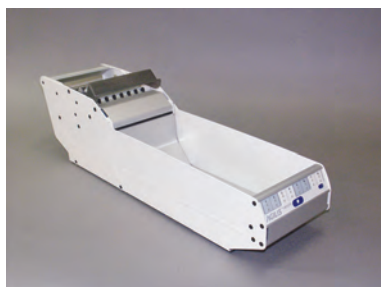

Description

The AGILIS Linear Magazine 1216, Agilis LM1216 holds up to 8 Agilis feeders for 12 or 16 mm component tape. Due to Agilis' unique feeder design, changeover and setup times can be significantly reduced. The two feeder types can be mixed freely in the magazine, which has a linear feeding mechanism that feeds the components into the machine with high accuracy and speed. The feeding pitch can be programmed to 2, 4, 8, 12 or 16 mm. When the magazine is inserted in the machine, each feeder is located and the pick positions are calculated. You can also fine-tune the pick positions with the joystick on the machine. An LED panel on the magazine shows the exact status of the feeders and reels. The magazine has a built-in service program and is low maintenance.

A handy Agilis Flexbin for easy handling of 4" to 15 " reels is included. Handles larger reels with Agilis bins for 13" reels or Agilis Large Reel Attachment.

Machine type:

TP9-1 , TP9-2 , TP9-3 , TP9-4 , TP11 , TP12 , TP18 , MY9 , MY12 , MY15 , MY19

Requirements:

Agilis Feeder 12 or 16, TPSys 2.4 or later, Magazine Control Unit including CAN, AT-CPU with 166MHz processor or later. For machines with HYDRA: HYDRA 21k or HYDRA ATE (long HYDRA tools) Midas tool requirements: Tool A14S, Tool A23 rev. D or A23S rev. B, Tool A24 rev. D or A24S rev. B

Part no.	Product name
L-014-1562	Agilis LM1216

Agilis Feeder 8 3.7



Description

The main feature in the AGILIS concept is the removable intelligent feeders. The feeder incorporates a new method for removing the cover tape that makes the take up reels redundant. The feeders can easily be moved from one feeder position to another in the magazine or machine, which makes reloading of feeders fast and easy.

This feeder is for 8 mm tape and has a cover tape separator width of 3.7 mm.

Component range: 01005 to 0402

Machine type:

Magazine , MY12 , MY15 , MY19 , MY9 , TP11 , TP12 , TP18 , TP9-1 , TP9-2 , TP9-3 , TP9-4

Requirements:

Agilis M8 or LM8

Part no.	Product name
L-014-1395	Agilis Feeder 8 3.7

Agilis Feeder 8 4.0



Description

The main feature in the AGILIS concept is the removable intelligent feeders. The feeder incorporates a new method for removing the cover tape that makes the take up reels redundant. The feeders can easily be moved from one feeder position to another in the magazine or machine, which makes reloading of feeders fast and easy.

This feeder is for 8 mm tape and has a cover tape separator width of 4.0 mm.

Machine type:

TP9-1 , TP9-2 , TP9-3 , TP9-4 , TP11 , TP12 , TP18 , MY9 , MY12 , MY15 , MY19

Requirements:

Agilis M8 and LM8.

Part no.	Product name
L-014-1320	Agilis Feeder 8 4.0

Agilis Feeder 8 4.7



Description

The main feature in the AGILIS concept is the removable intelligent feeders. The feeder incorporates a new method for removing the cover tape that makes the take up reels redundant. The feeders can easily be moved from one feeder position to another in the magazine or machine, which makes reloading of feeders fast and easy.

This feeder is for 8 mm tape and has a cover tape separator width of 4.7 mm.

Machine type:

TP9-1 , TP9-2 , TP9-3 , TP9-4 , TP11 , TP12 , TP18 , MY9 , MY12 , MY15 , MY19

Requirements:

Agilis M8 and LM8.

Part no.	Product name
L-014-1319	Agilis Feeder 8 4.7

Agilis Feeder 8 5.4



Description

The main feature in the AGILIS concept is the removable intelligent feeders. The feeder incorporates a new method for removing the cover tape that makes the take up reels redundant. The feeders can easily be moved from one feeder position to another in the magazine or machine, which makes reloading of feeders fast and easy.

This feeder is for 8 mm tape and has a cover tape separator width of 5.4 mm.

Machine type:

TP9-1 , TP9-2 , TP9-3 , TP9-4 , TP11 , TP12 , TP18 , MY9 , MY12 , MY15 , MY19

Requirements:

Agilis M8 and LM8.

Part no.	Product name
L-014-1321	Agilis Feeder 8 5.4

Agilis Feeder 12 8.5



Description

The main feature of the AGILIS concept is removable, intelligent feeders. The feeder incorporates a new method for removing the cover tape, which makes take-up reels redundant. In addition, the feeders can easily be moved from one feeder position to another in the magazine or the machine, which makes reloading them fast and easy.

This feeder is for 12 mm tape. It has a cover tape separator width of 8.5 mm and is suitable for most standard 12 mm tapes.

Requirements:
Agilis LM1216

Part no.	Product name
L-014-1490	Agilis Feeder 12 8.5

Agilis Feeder 12 Adjustable



Description

The main feature of the AGILIS concept is removable, intelligent feeders. The feeder incorporates a new method for removing the cover tape, which makes take-up reels redundant. In addition, the feeders can easily be moved from one feeder position to another in the magazine or the machine, which makes reloading them fast and easy.

This feeder is for 12 mm tape. It has an adjustable cover tape separator width and is suitable for tapes with very wide or narrow cover tapes.

Requirements:
Agilis LM1216

Part no.	Product name
L-014-1552	Agilis Feeder 12 Adjustable

Agilis Feeder 16 12.5



Description

The main feature of the AGILIS concept is removable, intelligent feeders. The feeder incorporates a new method for removing the cover tape, which makes take-up reels redundant. In addition, the feeders can easily be moved from one feeder position to another in the magazine or the machine, which makes reloading them fast and easy.

This feeder is for 16 mm tape. It has a cover tape separator width of 12.5 mm and is suitable for most standard 16 mm tapes.

Requirements:
Agilis LM1216

Part no.	Product name
L-014-1492	Agilis Feeder 16 12.5

Agilis Feeder 16 Adjustable



Description

The main feature of the AGILIS concept is removable, intelligent feeders. The feeder incorporates a new method for removing the cover tape, which makes take-up reels redundant. In addition, the feeders can easily be moved from one feeder position to another in the magazine or the machine, which makes reloading them fast and easy.

This feeder is for 16 mm tape. It has an adjustable cover tape separator width and is suitable for tapes with very wide or narrow cover tapes.

Requirements:
Agilis LM1216

Part no.	Product name
L-014-1553	Agilis Feeder 16 Adjustable

Tape Magazine TM8C

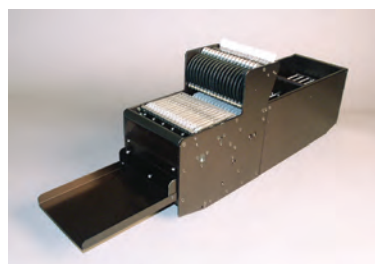

Description

The TM8C has sixteen 8 mm tape feeders. With its basic design and established track record, it is a reliable feeder for a wide range of tape types and reel sizes. All tape materials can be handled - paper, aluminium and plastic. Each feeder position is programmable to advance the tape by its predescribed pitch. Reel sizes: 7" (180 mm), 13" (330 mm), for 13" reels L-014-0260 or L-014-0710B is needed.

Machine type:

TP9-1 , TP9-2 , TP9-3 , TP9-4 , TP11 , TP12 , TP18 , MY9 , MY12 , MY15 , MY19

Part no.	Product name
L-014-0001D	Tape Magazine TM8C

Tape Magazine TM1216C

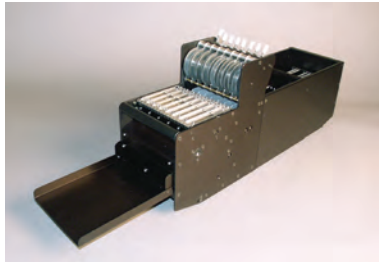

Description
 The TM1216C has four 12 mm tape feeders plus four 16 mm tape feeders. With its basic design and established track record, it is a reliable feeder for a wide range of tape types and reel sizes. All tape materials can be handled - paper, aluminium and plastic. Each feeder position is programmable to advance the tape by its prescribed pitch. Reel sizes: 7" (180 mm), 13" (330 mm), for 13" reels L-014-0260 or L-014-0710B is needed.

Machine type:
 TP9-1 , TP9-2 , TP9-3 , TP9-4 , TP11 , TP12 , TP18 , MY9 , MY12 , MY15 , MY19

Part no.	Product name
L-014-0006D	Tape Magazine TM1216C

Tape Magazine TM24D

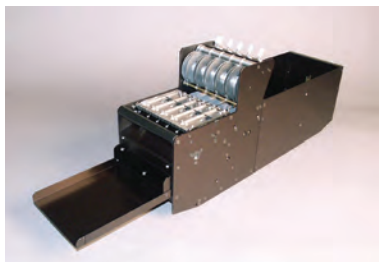

Description
 The TM24D has five 24 mm tape feeders plus one 8 mm feeder. With its basic design and established track record, it is a reliable feeder for a wide range of tape types and reel sizes. All tape materials can be handled - paper, aluminium and plastic. Each feeder position is programmable to advance the tape by its prescribed pitch. Reel sizes: 7" (180 mm), 13" (330 mm). Max. tape depth = 16 mm (0.63").

Machine type:
 TP9-1 , TP9-2 , TP9-3 , TP9-4 , TP11 , TP12 , TP18 , MY9 , MY12 , MY15 , MY19

Part no.	Product name
L-014-0004E	Tape Magazine TM24D

Tape Magazine TM32D

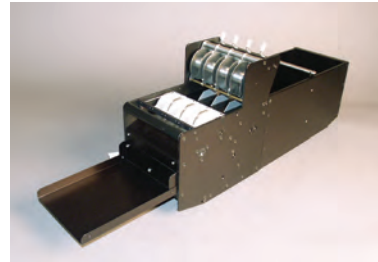

Description
 The TM32D has four 32 mm tape feeders. With its basic design and established track record, it is a reliable feeder for a wide range of tape types and reel sizes. All tape materials can be handled - paper, aluminium and plastic. Each feeder position is programmable to advance the tape by its prescribed pitch. Reel sizes: 7" (180 mm), 13" (330 mm). Max. tape depth = 16 mm (0.63").

Machine type:
 TP9-1 , TP9-2 , TP9-3 , TP9-4 , TP11 , TP12 , TP18 , MY9 , MY12 , MY15 , MY19

Part no.	Product name
L-014-0007E	Tape Magazine TM32D

Tape Magazine TM44D

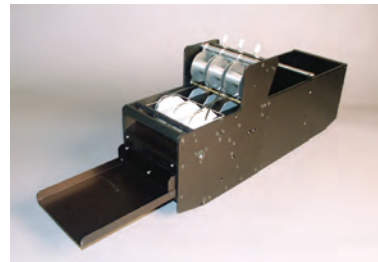

Description
 The TM44D has three 44 mm tape feeders. With its basic design and established track record, it is a reliable feeder for a wide range of tape types and reel sizes. All tape materials can be handled - paper, aluminium and plastic. Each feeder position is programmable to advance the tape by its prescribed pitch. Reel sizes: 7" (180 mm), 13" (330 mm). Max. tape depth = 16 mm (0.63").

Machine type:
 TP9-1 , TP9-2 , TP9-3 , TP9-4 , TP11 , TP12 , TP18 , MY9 , MY12 , MY15 , MY19

Part no.	Product name
L-014-0008E	Tape Magazine TM44D

Tape Magazine TM5632D

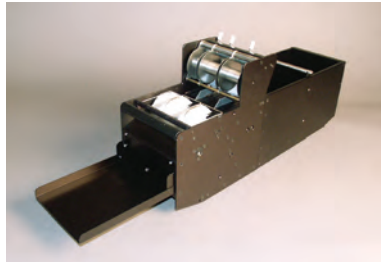

Description

The TM5632D has two 56 mm feeders plus one 32 mm feeder. With its basic design and established track record, it is a reliable feeder for a wide range of tape types and reel sizes. All tape materials can be handled - paper, aluminium and plastic. Each feeder position is programmable to advance the tape by its predescribed pitch. Reel sizes: 7" (180 mm), 13" (330 mm). Max. tape depth = 16 mm (0.63").

Machine type:

TP9-1 , TP9-2 , TP9-3 , TP9-4 , TP11 , TP12 , TP18 , MY9 , MY12 , MY15 , MY19

Part no.	Product name
L-014-0009E	Tape Magazine TM5632D

Tape Clip Magazine



Description

With the Tape Clip Magazine, short lengths of tape can be used conveniently and effectively. Any common width of tape of any practical length can be fitted and mounted from the Y Wagon. Due to variable width positions different combinations of tape sizes can be fitted alongside each other.

The maximum capacity of the Tape Clip Magazine 75 mm is equivalent to 5 x 8 mm tapes (60 mm (2.36") between outer rails). The maximum capacity of the Tape Clip Magazine 150 mm is equivalent to 11 x 8 mm tapes (128 mm (5.04") between outer rails). Each magazine comes with three rails which together will hold 2 tapes. Extra rails are also available.

For an extra rail order article number L-014-0855.

Requirements:

Tape Clip Magazine 75 mm (L-014-0772) or Tape Clip Magazine 150 mm (L-014-0771).

Part no.	Product name
L-014-0772	Tape Clip Magazine 75 mm
L-014-0771	Tape Clip Magazine 150 mm
L-014-0855	Tape Clip Magazine Rail

Agilis Bin 7"



Description

An important part of the Agilis concept is the removable bin. The bin is used to hold and store component reels. Instead of changing magazines when changing jobs in the machine, bins can be preloaded and stored on a shelf with the reels already fed into the feeders so that changeover time is minimized. You can also preload the bins in the order set for runtime optimization by MYPlan, for example, to achieve higher production throughput.

The bin handles up to eight 7" tape reels. Delivered as a set of two bins.

Requirements:

Agilis M8 or LM8

Part no.	Product name
L-014-1568	Agilis Bin 7"

Agilis Bin13"

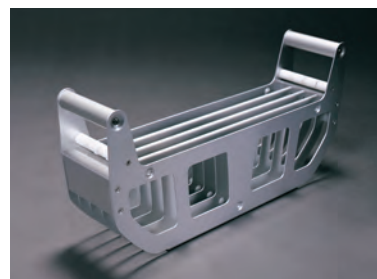

Description

An important part of the Agilis concept is the removable bin. The bin is used to carry and store the component reels.

Instead of changing magazines when changing jobs in the machine, bins can be preloaded and stored on a shelf with reels connected to feeders, so changeover time is minimized. It is also convenient to preload the bins in the order according to run-time optimization from e.g. MYSpeed, in order to reach a high production throughput.

Two bins for 13" tape reels are included. Each bin can hold eight 13" tape reels.

Requirements:
Agilis M8 and LM8

Part no.	Product name
L-014-1358	Agilis Bin13"

Agilis Flexbin 13"



Description

An important part of the Agilis concept is the removable bin. The bin is used to hold and store component reels. Instead of changing magazines when changing jobs in the machine, bins can be preloaded and stored on a shelf with the reels already fed into the feeders so that changeover time is minimized. You can also preload the bins in the order set for runtime optimization by MYSpeed, for example, to achieve higher production throughput.

The bin handles reels with a diameter of 4" to 15". It has movable walls so that the bin can hold reels of different widths.

Requirements:
Agilis M8, LM8 or LM1216

Part no.	Product name
L-014-1569	Agilis Flexbin 13"

Agilis Bin Wall



Description

The Bin walls holds the reels in the Agilis Flexbin. They can be positioned freely in the bin in order to handle reels of different widths. Delivered as a set of 4.

Requirements:
Agilis Flexbin 13"

Part no.	Product name
L-014-1570	Agilis Bin Wall

Agilis Large Reel Attachment



Description

The new Agilis Large Reel Attachment (LRA) can be fitted in four different places on the Agilis magazine. Each attachment has adjustable angles to suit individual arrangements of tape reels. Four LRAs can be connected to the magazine at the same time.

Each LRA holds up to four 13" reels of 8, 12 or 16 mm tapes.

Requirements:
Agilis M8 or LM8

Part no.	Product name
L-014-1359	Agilis Large Reel Attachment

Agilis Storage Box



Description

A storage box in black ESD plastic which can carry 16 feeders. To show which feeders are contained, color-coded stickers are included for marking the boxes.

Part no.	Product name
L-014-1361	Agilis Storage Box

Agilis Feeder Rack



Description

A feeder rack for convenient storage of Agilis feeders. The rack can hold all types of Agilis feeders, from 8mm up to 16 mm, in any combination. Up to 16 (8 mm) feeders can be stored in the rack. It is supplied ready for easy setup in storage shelves.

Part no.	Product name
L-014-1623	Agilis Feeder Rack

Tape Seal 8



Description

A plastic sealing for convenient sealing of 8 mm component tapes after unloading from Agilis feeders. This fixates any exposed components inside the tape pockets.

Part no.	Product name
L-014-1600	Tape Seal 8

Tape Seal 1216

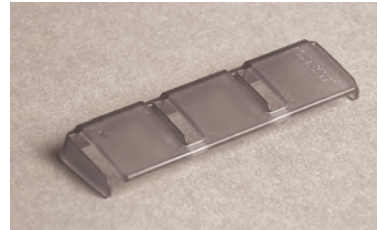

Description

A plastic sealing for convenient sealing of 12 or 16 mm component tapes after unloading from Agilis feeders. This fixates any exposed components inside the tape pockets.

Part no.	Product name
L-014-1572	Tape Seal 1216

Large Reel Conversion Kit

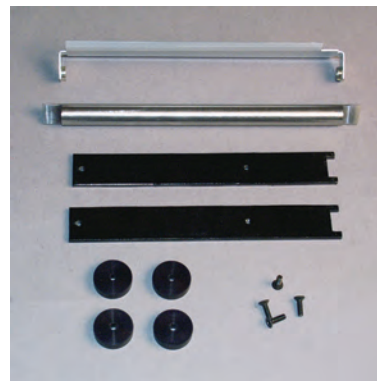

Description

This kit is for conversion of TM magazines (TM8, 12, 16) from small/standard-reel capability to large 13" (330 mm) reel capability. The reels are positioned in the magazine box with the axle included in the kit. Please also see Large Reel Attachment for additional large reel solutions.

Requirements:
TM8, 12, or 16.

Part no.	Product name
L-014-0260	Large Reel Conversion Kit

Large Reel Attachment



Description
 MYDATA provides a stable reel attachment for use with large tape reels. The attachment, that mounts on the rear flange of the magazine, holds from 8 mm to 32 mm tape reels. It is divided in two pegs which makes it easy to change the reels attached. An innovative tension spring prevents the reels from free-spinning.

Part no.	Product name
L-014-0710B	Large Reel Attachment

Large Reel Attachment Axle Set

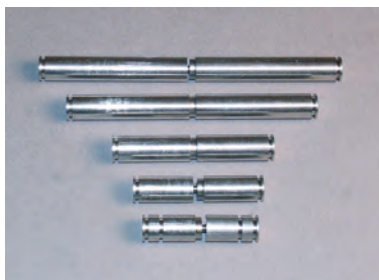

Description
 This set contains a range of replaceable axles for Large Reel Attachment L-014-0710B. Includes axles for the following tape reels 8-12 mm, 16 mm, 24 mm, 44 mm, 56 mm.

Part no.	Product name
L-014-0848	Large Reel Attachment Axle Set

Magazine Trolley



Description
 Robust trolley that holds two magazines for loading and unloading onto a MYDATA machine. There is also space on the lower shelf for two additional magazines. Includes one shelf with wooden plate as standard. Adjustable for any machine height.

Part no.	Product name
K-017-0286	Magazine Trolley

Tool Tray Magazine Trolley



Description
 Convenient tool tray mounted on the feeder trolley.

Part no.	Product name
K-017-0287	Tool Tray Magazine Trolley

Tool Tray ESD Insert

Description
 ESD safe plastic insert for the magazine tool tray.

Part no.	Product name
K-017-0289	Tool Tray ESD Insert

ESD Insert for Trolley Shelf

Description
Optional ESD safe plastic insert for the shelves on the trolley.

Part no.	Product name
K-017-0292	ESD Insert for Trolley Shelf

Document Holder Magazine Trolley



Description
Document holder on moveable arm for the magazine trolley.

Part no.	Product name
K-017-0290	Document Holder Magazine Trolley

Holder cover TM12



Description
Machine type:
Magazine

Part no.	Product name
D-014-1728	Holder cover TM12

TMFC Rev.2 Upgrade

Description
For refurbishing a fine pitch TM8FC magazine to Rev. 2 standard.

Part no.	Product name
L-014-0914	TMFC Rev.2 Upgrade

TMFC Rev.1 to Rev.2 Upgrade

Description
For refurbishing a fine pitch TM8FC magazine from Rev. 1 standard to Rev. 2 standard.

Part no.	Product name
L-014-0915	TMFC Rev.1 to Rev.2 Upgrade

TM8B Rev.1 Upgrade

Description
For refurbishing a TM8B magazine to Rev. 1 standard.

Part no.	Product name
L-014-0865	TM8B Rev.1 Upgrade

TM8C Rev.1 Upgrade

Description
For refurbishing a TM8C magazine to Rev. 1 standard.

Part no.	Product name
L-014-0866	TM8C Rev.1 Upgrade

TM12C Rev.1 Upgrade

Description
For refurbishing a TM12C magazine to Rev. 1 standard.

Part no.	Product name
L-014-0867	TM12C Rev.1 Upgrade

TM12/16C Rev.1 Upgrade

Description
For refurbishing a TM12/16C magazine to Rev. 1 standard.

Part no.	Product name
L-014-0873	TM12/16C Rev.1 Upgrade

TM16C Rev.1 Upgrade

Description
For refurbishing a TM16C magazine to Rev. 1 standard.

Part no.	Product name
L-014-0872	TM16C Rev.1 Upgrade

TM24C Rev.1 Upgrade

Description
For refurbishing a TM24C magazine to Rev. 1 standard.

Part no.	Product name
L-014-0868	TM24C Rev.1 Upgrade

TM32C Rev.1 Upgrade

Description
For refurbishing a TM32C magazine to Rev. 1 standard.

Part no.	Product name
L-014-0869	TM32C Rev.1 Upgrade

TM44, 56/32C Rev.1 Upgrade

Description
For refurbishing a TM56/32C magazine to Rev. 1 standard.

Part no.	Product name
L-014-0871	TM44, 56/32C Rev.1 Upgrade

TM32C > D Upgrade

Description
For upgrading a TM32C magazine to TM32D, for deep components.

Part no.	Product name
L-014-0905	TM32C > D Upgrade

TM44C > D Upgrade

Description
For upgrading a TM44C magazine to TM44D, for deep components.

Part no.	Product name
L-014-0906	TM44C > D Upgrade

TM56/32C > D Upgrade

Description
For upgrading a TM56/32C magazine to TM56/32D, for deep components.

Part no.	Product name
L-014-0907	TM56/32C > D Upgrade

Tape Magazine TMD Flex

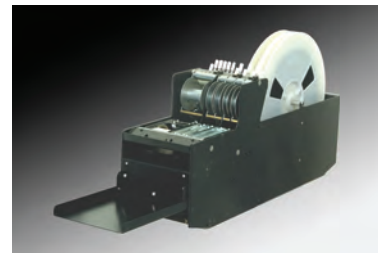

Description
The TM Flex magazine enables you to configure a wide variety of single- or multi-feeders in one magazine. The feeders can easily be removed to set up the magazine for new jobs, enabling cost-effective flexibility while reducing overall magazine inventory. It's the ideal solution for handling those extra tape sizes, in addition to the tapes used in the Agilis or TM-Series. The TM Flex series comprises a wide range of single or multi Flex feeders for tapes from 8 mm up to 72 mm as well as the configurable Flex feeder for 32-136 mm tapes.

The maximum number of Flex Feeders that can be fitted in a TM Flex magazine depends on the module width of each feeder. The magazine has a width of 17 modules.

Machine type:
TP9-1 , TP9-2 , TP9-3 , TP9-4 , TP11 , TP12 , TP18 , MY9 , MY12 , MY15 , MY19

Requirements:
Flex Feeders

Part no.	Product name
L-014-0442E	Tape Magazine TMD Flex

Flex Feeder 1 x 8 mm



Description
A Flex Feeder for one 8 mm tape. Module size = 2.

Requirements:
Tape Magazine TMC Flex or TMD Flex.

Part no.	Product name
L-014-0416	Flex Feeder 1 x 8 mm

Flex Feeder 2 x 8 mm



Description
A Flex Feeder for two 8 mm tapes. Module size = 3.

Requirements:
Tape Magazine TMC Flex or TMD Flex.

Part no.	Product name
L-014-0410	Flex Feeder 2 x 8 mm

Flex Feeder 4 x 8 mm



Description
A Flex Feeder for four 8 mm tapes. Module size = 5.

Requirements:
Tape Magazine TMC Flex or TMD Flex.

Part no.	Product name
L-014-0406	Flex Feeder 4 x 8 mm

Flex Feeder 1 x 12 mm



Description
A Flex Feeder for one 12 mm tape. Module size = 2.

Requirements:
Tape Magazine TMC Flex or TMD Flex.

Part no.	Product name
L-014-0403	Flex Feeder 1 x 12 mm

Flex Feeder 2 x 12 mm



Description
A Flex Feeder for two 12 mm tapes. Module size = 4.

Requirements:
Tape Magazine TMC Flex or TMD Flex.

Part no.	Product name
L-014-0417	Flex Feeder 2 x 12 mm

Flex Feeder 1 x 16 mm



Description

A Flex Feeder for one 16 mm tape. Module size = 3.

Max. tape depth with TMD Flex Magazine:
Standard = 15 mm*
Max. tape depth with TMC Flex Magazine:
Standard = 7.5 mm
With Flex Magazine Conversion Kit-D (L-014-0749) = 15 mm

*Rotatable Shaft (D-014-1155) may be required for early versions, please check the shaft type in the specific magazine.

Requirements:

TMC or TMD Flex magazine. Please also order Flex Magazine Conversion Kit-D (L-014-0749) or Rotatable shaft (D-014-1155) if required.

Part no.	Product name
L-014-0912	Flex Feeder 1 x 16 mm

Flex Feeder 2 x 16 mm



Description

A Flex Feeder for two 16 mm tapes. Module size = 5.

Requirements:

Tape Magazine TMC Flex or TMD Flex.

Part no.	Product name
L-014-0418	Flex Feeder 2 x 16 mm

Flex Feeder 12 + 16 mm



Description

A Flex Feeder for a 12 mm and a 16 mm tape. Module size = 4.

Requirements:

Tape Magazine TMC Flex or TMD Flex.

Part no.	Product name
L-014-0415	Flex Feeder 12 + 16 mm

Flex Feeder 1 x 24 mm



Description

A Flex Feeder for one 24 mm tape. Module size = 3.

Max. tape depth with TMD Flex Magazine:
Standard = 15 mm*
Max. tape depth with TMC Flex Magazine:
Standard = 7.5 mm
With Flex Magazine Conversion Kit-D (L-014-0749) = 15 mm

*Rotatable Shaft (D-014-1155) may be required for early versions, please check the shaft type in the specific magazine.

Requirements:

Tape Magazine TMC Flex or TMD Flex. Please also order Flex Magazine Conversion Kit-D (L-014-0749) or Rotatable shaft (D-014-1155) if required.

Part no.	Product name
L-014-0419	Flex Feeder 1 x 24 mm

Flex Feeder 1 x 32 mm



Description

A Flex Feeder for one 32 mm tape. Module size = 4.

Max. tape depth with TMD Flex Magazine:

Standard = 15 mm*

Max. tape depth with TMC Flex Magazine:

Standard = 7.5 mm

With Flex Magazine Conversion Kit-D (L-014-0749) = 15 mm

*Rotatable Shaft (D-014-1155) may be required for early versions, please check the shaft type in the specific magazine..

Requirements:

Tape Magazine TMC Flex or TMD Flex. Please also order Flex Magazine Conversion Kit-D (L-014-0749) or Rotatable shaft (D-014-1155) if required.

Part no.	Product name
----------	--------------

L-014-0421	Flex Feeder 1 x 32 mm
------------	-----------------------

Flex Feeder 1 x 44 mm



Description

A Flex Feeder for one 44 mm tape. Module size = 5.

Max. tape depth with TMD Flex Magazine:

Standard = 15 mm*

Max. tape depth with TMC Flex Magazine:

Standard = 7.5 mm

With Flex Magazine Conversion Kit-D (L-014-0749) = 15 mm

*Rotatable Shaft (D-014-1155) may be required for early versions, please check the shaft type in the specific magazine.

Requirements:

Tape Magazine TMC Flex or TMD Flex. Please also order Flex Magazine Conversion Kit-D (L-014-0749) or Rotatable shaft (D-014-1155) if required.

Part no.	Product name
----------	--------------

L-014-0422	Flex Feeder 1 x 44 mm
------------	-----------------------

Flex Feeder 1 x 56 mm



Description

A Flex Feeder for one 56 mm tape. Module size = 7.

Max. tape depth with TMD Flex Magazine:

Standard = 15 mm*

Max. tape depth with TMC Flex Magazine:

Standard = 7.5 mm

With Flex Magazine Conversion Kit-D (L-014-0749) = 15 mm

*Rotatable Shaft (D-014-1155) may be required for early versions, please check the shaft type in the specific magazine.

Requirements:

Tape Magazine TMC Flex or TMD Flex. Please also order Flex Magazine Conversion Kit-D (L-014-0749) or Rotatable shaft (D-014-1155) if required.

Part no.	Product name
----------	--------------

L-014-0423	Flex Feeder 1 x 56 mm
------------	-----------------------

Flex Feeder 1 x 72 mm

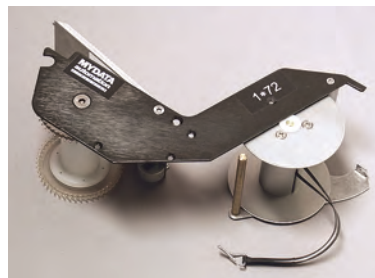

Description

A Flex Feeder for one 72 mm tape. Module size = 8. For use in magazine position 1-16.

Max. tape depth with TMD Flex Magazine:

Standard = 10 mm

On request = 15 mm

Max. tape depth with TMC Flex Magazine:

Standard = 7.5 mm

On request = 15 mm

Machine type:
Magazine

Requirements:
Tape Magazine TMC Flex or TMD Flex. Stated tape depth requires that the tape pockets don't come in contact with each other when the tape is bent by the feeding wheel (radius 30 mm.).

Part no.	Product name
L-014-1458	Flex Feeder 1 x 72 mm

Flex Feeder 32 - 136 mm



Description
The Flex Feeder 32-136 feeds tape 32 to 136 mm wide. It can be adjusted for different tape widths by simply adjusting the position of one of its sides. The feeder comes with two sets of shafts.
Module size, long shafts: 17 (max width 136 mm)
Module size, short shafts: 11 (max width 72 mm)
Max. tape depth:
Standard = 10 mm
Modified magazine = 25 mm*
* Other Flex Feeders cannot be inserted into the magazine. Machine configuration may limit the mountable height.

Machine type:
Magazine

Requirements:
Tape Magazine TMD Flex.

Part no.	Product name
L-014-1500	Flex Feeder 32 - 136 mm

Flex Magazine Conversion Kit - D

Description
This kit converts a TMC Flex Magazine to version TMD in order to be able to feed deeper tapes in a specific position (no. 11) in the magazine. The kit comprises a rotatable shaft (D-014-1155) and parts for converting the magazine front handle.
Max. depth after conversion = 15 mm (0.59").

Requirements:
Flex feeder 1x16, 1x24, 1x32, 1x44 or 1x56 is required to obtain max. depth.

Part no.	Product name
L-014-0749	Flex Magazine Conversion Kit - D

Rotatable Shaft Deep Flex



Description
This shaft enables feeding of deeper tapes in a specific position (no. 11) in the magazine. It is suitable for early versions of TMD Flex magazines (this shaft is standard feature on new TMD Flex magazines).
For normal use the round surface of the shaft is facing up, enabling full usage of all slots with tape up to 10mm (0.39") depth. If the shaft is turned so that its planar surface is facing up, one fixed feeder position (no. 11, other positions on request) is provided which enables the passage of up to 15 mm (0.59") deep tape. However, with the shaft in this position, the feeder positions 12 to 15 can not be used.

Requirements:
Flex feeder 1x16, 1x24, 1x32, 1x44 or 1x56 is required to obtain max. depth.

Part no.	Product name
D-014-1155	Rotatable Shaft Deep Flex

Holder cover for Flex feeder 32

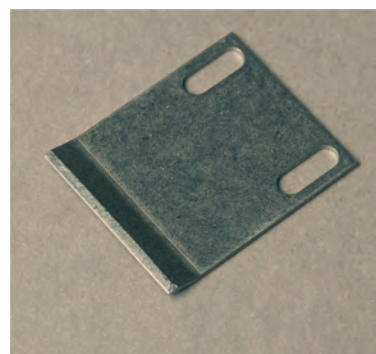

Description
For adjusting how much of the tape pocket is exposed. Suitable for small and light components.

Machine type:
Magazine

Requirements:
TM Flex feeder 32

Part no.	Product name
D-014-1923	Holder cover for Flex feeder 32

Holder cover for Flex feeder 44

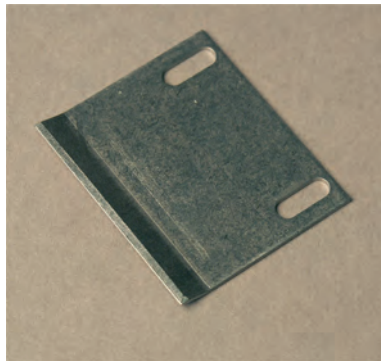

Description
For adjusting how much of the tape pocket is exposed. Suitable for small and light components..

Machine type:
Magazine

Requirements:
TM Flex feeder 44

Part no.	Product name
D-014-1924	Holder cover for Flex feeder 44

Holder cover for Flex feeder 56

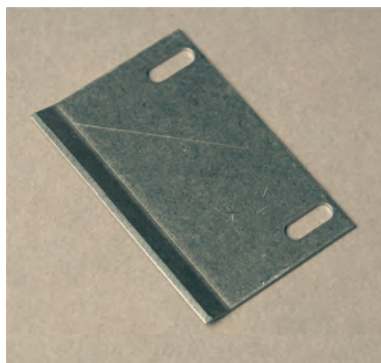

Description
For adjusting how much of the tape pocket is exposed. Suitable for small and light components.

Machine type:
Magazine

Requirements:
TM Flex feeder 56

Part no.	Product name
D-014-1925	Holder cover for Flex feeder 56

Holder cover for Flex feeder 72

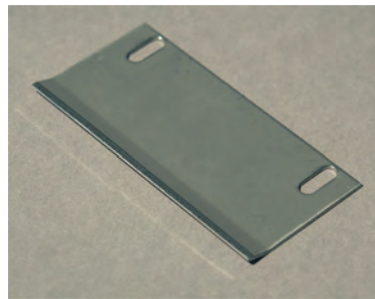

Description
For adjusting how much of the tape pocket is exposed. Suitable for small and light components.

Machine type:
Magazine

Requirements:
TM Flex feeder 72

Part no.	Product name
D-014-1926	Holder cover for Flex feeder 72

TEX Tray Exchanger



Description
With up to 32 JEDEC matrix trays, a dual track design and a series of intelligent functions, the Tray Exchanger (TEX) is the ideal solution for matrix tray management. The dual track design allows

the MYDATA placement machine to pick from one track while the other is being changed.

Intelligent functions include an empty tray warning plus a built-in barcode system for tray recognition, thus eliminating the need for programming when trays are replenished. Tray acceleration is also controllable to protect delicate components. It is possible to use several TEXs on one machine, since each TEX uses only two magazine positions.

The TEX can be configured for either narrow or wide tray pallets during installation. The maximum number of tray pallets is 32 narrow or 16 wide. No cassettes, tray pallets or TEX magnets are included.

Narrow pallet dimensions (w x l): 143 x 337 mm (5.6" x 13.2"). Wide pallet dimensions (w x l): 300 x 337 mm (11.8" x 13.3"). Max. component height: 14 mm (0.55")(incl.tray height) with the above tray position loaded with a pallet.

Requirements:
TPSys 2.0 or later.

Ordering info:
Please order cassettes, tray pallets and TEX magnets separately. A minimum of 6 narrow pallets or 3 wide pallets is required for installation of the TEX. If a Glue Station is to be used on the same machine as the TEX, the Glue Station must be the new Glue Station 2. If the target machine for the TEX is a TP-Series machine or a MY19 with a serial number lower than 19041 then an upgrade kit is needed (L-010-0733). MYDATA automation will add this to the order.

Part no.	Product name
L-024-0100B	TEX Tray Exchanger

TEX Narrow Cassette

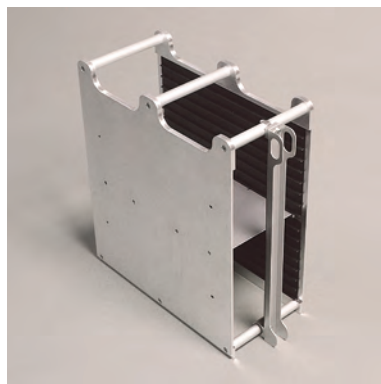

Description
An extra cassette allows for quicker matrix tray replenishment. The cassette can also be used for convenient matrix tray storage. The Narrow Cassette has space for 16 Standard Pallets.

Machine type:
Tray Exchanger

Ordering info:
Please order tray pallets and TEX magnets separately.

Part no.	Product name
L-024-0192	TEX Narrow Cassette

TEX Wide Cassette

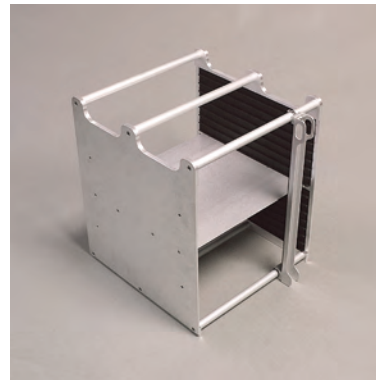

Description
An extra cassette allows for quicker matrix tray replenishment. The cassette can also be used for convenient matrix tray storage. The Wide Cassette has space for 16 Wide Pallets.

Machine type:
Tray Exchanger

Ordering info:
Please order tray pallets and TEX magnets separately.

Part no.	Product name
L-024-0193	TEX Wide Cassette

TEX Pallet Narrow JEDEC, 2 pcs

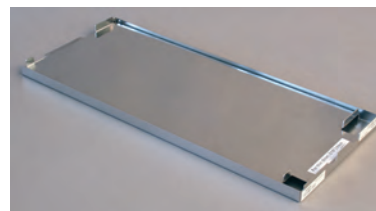

Description
This tray pallet fits in the TEX narrow cassette and is specially designed for 8mm JEDEC trays. This tray pallet makes handling thin JEDEC trays faster and easier. Dimensions (w x l): 143 x 323mm (5.6" x 12.7"). Max. component height including tray: 8 mm (0.3")*

* With a pallet inserted in the slot above. If pallets in the slots above are removed, the max. component height including tray is 33 mm (1.3")

Machine type:
Tray Exchanger

Part no.	Product name
L-024-0190	TEX Pallet Narrow JEDEC, 2 pcs

TEX Pallet Narrow Spring, 2 pcs



Description

This tray pallet fits in the TEX narrow cassette. Springs on the pallet edges keep the matrix tray in position. Narrow pallet dimensions (w x l): 143 x 337 mm (5.6" x 13.2"). Max. component height including tray: 16 mm (0.7")*

* With a pallet inserted in the slot above. If pallets in the slots above are removed, the max. component height including tray is 40 mm (1.57")

Machine type:
Tray Exchanger

Part no.	Product name
L-024-0194	TEX Pallet Narrow Spring, 2 pcs

TEX Pallet Narrow, 2 pcs



Description

This tray pallet fits in the TEX narrow cassette. The bottom surface of the pallet does not have holes and therefore is suitable for use with irregular-sized trays. Dimensions (w x l): 143 x 337 mm (5.6" x 13.2"). Max. component height including tray: 16 mm (0.7")*

* With a pallet inserted in the slot above. If pallets in the slots above are removed, the max. component height including tray is 40 mm (1.57")

Machine type:
Tray Exchanger

Part no.	Product name
L-024-0195	TEX Pallet Narrow, 2 pcs

TEX Wide Pallet

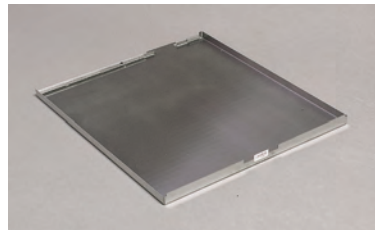

Description

This tray pallet fits in the TEX wide cassette. The bottom surface of the pallet does not have holes and therefore is suitable for use with irregular sized trays. Wide Pallet dimensions (w x l): 300 x 337 mm (11.8" x 13.3"). Max. component height including tray: 16 mm (0.7")*

* With a pallet inserted in the slot above. If pallets in the slots above are removed, the max. component height including tray is 40 mm (1.57")

Machine type:
Tray Exchanger

Part no.	Product name
L-024-0196	TEX Wide Pallet

TEX Magnet



Description

For securing trays on pallets.

Machine type:
Tray Exchanger

Part no.	Product name
U-024-0006	TEX Magnet

Machine Upgrade Kit for TEX

Description

If ordering a TEX for a TP-Series machine or a MY-Series machine with a serial number lower than 19041, then this upgrade kit is needed.

Machine type:
Tray Exchanger

Ordering info:

When ordering, please also send a configuration form.

Part no.	Product name
L-010-0733	Machine Upgrade Kit for TEX

Tray Wagon Magazine

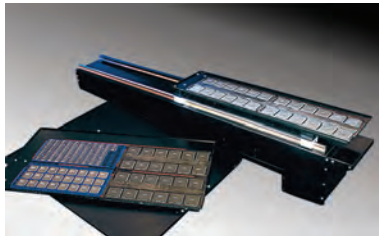

Description

The Tray Wagon Magazine, TWM, provides matrix tray capability for use when limited quantities of trays are required. It has its own table which moves parallel to the y-axis. Tray capacity for the Tray Wagon Magazine is dependent upon the table module selected. Table modules are available in size from a single module which occupies one magazine space and holds up to 2 JEDEC trays, to a two module table which occupies two magazine spaces and holds up to 5 JEDEC trays, or even a three module table that occupies three magazine spaces and holds up to 7 JEDEC trays. All are interchangeable and easy to set up.

Note:

When the T-Series or 500T2 inline solution is used, the accessible table area is reduced due to the space taken up by the conveyor.

1 Module Table size = 172 x 540 mm (6.77" x 21.26") (1 JEDEC tray)

2 Module Table size = 352 x 540 mm (13.85" x 21.26") (4 JEDEC trays)

3 Module Table size = 514 x 540 mm (20.24" x 21.26") (5 JEDEC trays)

Requirements:

TWM table (L-025-0072, L-025-0073, or L-025-0074).

Part no.	Product name
L-025-0001	Tray Wagon Magazine TWM
L-025-0072	1 Module Table for TWM
L-025-0073	2 Module Table for TWM

Part no.	Product name
L-025-0074	3 Module Table for TWM

Y Wagon Tray Holder



Description

An easy to use and install accessory for matrix tray handling which suits any MYDATA Y Wagon. Each kit contains four magnetic corner holders plus four under-tray supports and can hold one tray of any size. There are no adjustments to be made and no tools are required, simply position a tray on the four corner holders on the Y Wagon, teach its location and start picking.

Machine type:

TP9-1 , TP9-2 , TP9-3 , TP9-4 , TP11 , TP12 , TP18 , MY9 , MY12 , MY15 , MY19

Part no.	Product name
L-015-0277B	Y Wagon Tray Holder

Generic Feeder Interface, GFI

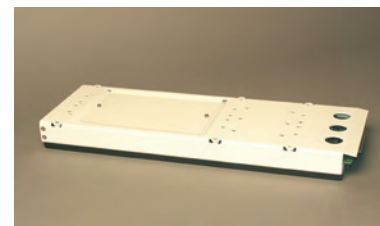

Description

The GFI is an open mechanical and electrical interface for connecting and running non-MYDATA feeders on MY or TP machines. This enables a wide variety of different parts to be fed to the machine's pick-and-place head. The GFI handles two feeders and up to ten parallel components per feeder. The GFI is fitted into the magazine slot in the machine, so it can be easily inserted in or removed from any position in the machine.

For safety instructions, liability and further details of how to adapt a non-MYDATA feeder to the machine using the GFI, please refer to the GFI Interface description P-014-0006. Please also contact the feeder manufacturer or MYDATA Customized projects dept. for further assistance with adopting feeders.

Machine type:

TP9-1 , TP9-2 , TP9-3 , TP9-4 , TP11 , TP12 , TP18 , MY9 , MY12 , MY15 , MY19

Requirements:

TPSys 2.3.3 or later. Servo release 8.1e or later. MOT3 on M. External feeder capable following the GFI standard. Interface mechanics for the external feeder (not included). Interface cabling to the external feeder (not included).

Part no.	Product name
L-014-1483	Generic Feeder Interface, GFI

Vibratory Magazine VMF30



Description

A wide range of components may be used with this magazine, from chips to PLCC 100 (1.4" sq.) supplied in stick and tube format. Individual fine adjustment for each component advancement is controlled through software parameters. Different sized components can be fed by the same magazine due to 3 independent vibration rails and a wide variety of tubefork fittings. The number of tubeforks that can be fitted in the magazine is dependent of the module of the tubeforks. There are 10 modules per rail, totally 30 per magazine. Tubeforks need to be ordered separately.

Tubeforks for all common components are available. However, for unusual components customized tubeforks can be delivered on request. Please contact MYDATA automation for further information.

Requirements:

Tubeforks.

Part no.	Product name
L-014-0016B	Vibratory Magazine VMF30

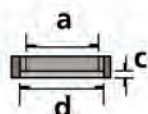
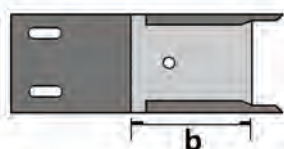

a Component width min-max (mm)
 b Component length min-max (mm)
 c Component elevation min-max (mm)
 d Tube width (mm)

Part no.	Product name	a	b	c	d	Modules
L-014-0062D	Tubefork SO-8 (Plastic)	5.9 - 6.4	4.1 - 5.5	0.8	8.0	2
L-014-0816	Tubefork SOW-8	7.8 - 8.3	15.0 - 21.0	0.9	11.0	3
L-014-0065D	Tubefork SO-14,/16	5.9 - 6.4	7.5 - 10	0.9	8.0	2
L-014-0076	Tubefork SO-14W	7.8 - 8.3	10.5 - 14.0	1.6	15.0	3
L-014-0087	Tubefork SOMC 14-16	7.5 - 8.0	10.5 - 14.0	0.6	10.8	3
L-014-0064D	Tubefork SO-20/28 (Plastic)	10.3 - 10.8	12.4 - 16.5	1.0	15.0	4
L-014-0066	Tubefork PLCC 18	8.2 - 8.7	8.2 - 18.0	0.7	10.8	3
L-014-0067	Tubefork PLCC 20	9.4 - 9.9	9.4 - 15.0	0.7	11.8	3
L-014-0068	Tubefork PLCC 28 / 32	12.3 - 12.8	12.3 - 18.0	0.7	15.1	4
L-014-0069	Tubefork PLCC 44	17.4 - 17.9	17.4 - 23.0	0.7	20.5	6
L-014-0063	Tubefork PLCC 52	20.1 - 20.6	20.1 - 26.0	0.7	22.8	6
L-014-0070	Tubefork PLCC 68	25.1 - 25.6	25.1 - 31.0	0.7	28.0	6
L-014-0071	Tubefork PLCC 84	30.5 - 31.0	30.5 - 35.0	0.7	33.7	8
L-014-0060	Tubefork PHILIPS 1	12.3 - 12.5	7.0 - 9.0	1.1	15.9	4
L-014-0268	Tubefork LCC 18-28, SOJ24-26	8.6 - 9.1	13.5 - 18.0	0.6	11.0	3
L-014-0269	Tubefork LCC 28-32	11.1 - 11.6	14.25 - 19.0	0.6	13.5	4
L-014-0303	Tubefork DIP24	7.0 - 8.9	25.0 - 40.0	5.0	10.5	3
L-014-0126B	Tubefork Multi LCCC 18-28	8.5 - 9.0	10.0 - 15.8	0.7	11.0	10
L-014-0432	Tubefork Multi SO-8	6.0 - 6.5	5.0 - 7.5	0.9	8.0	10
L-014-0364	Tube fork 5xSO8					
L-014-0433	Tubefork Multi SO-14/ 18	6.0 - 6.5	9.0 - 13.0	0.9	8.0	10
L-014-0434	Tubefork Multi SO-24/28	10.3 - 10.8	14.0 - 23.0	0.9	15.0	10
L-014-0435	Tubefork Multi PLCC 20	9.3 - 9.8	15.0 - 26.5	0.7	11.8	10
L-014-0436	Tubefork Multi PLCC 28	12.2 - 12.7	18.0 - 28.0	0.7	15.1	10
L-014-0437	Tubefork Multi SOMC-14/16	7.4 - 7.9	10.0 - 15.5	0.5	10.8	10
L-014-0438	Tubefork Mix SO-8/SO-14,18	6.0 - 6.5	7.0 - 12.5	0.9	8.0	10
L-014-0363	Tube fork 2xSO8+3xSO14-16					
L-014-0439	Tubefork Multi PLCC 20 split	9.5 - 10.1	10.0 - 22.0	0.7	11.8	10
L-014-0440	Tubefork Multi SOJW-40	14.7 - 15.2	17.0 - 27.0	0.8	14.5	10
L-014-0441	Tubefork Mix 2xDIP8 + 1xPLCC20	9.5 - 10.3	10.0 - 22.0	0.7	11.8	10
L-014-0088	Tubefork DIL-6	8.3 - 8.8	9.75 - 13.0	6.6	12.4	3
L-014-0817	Tubefork PLCC 20 Socket	14.9 - 15.4	14.9 - 23.0	2.5	17.5	5
L-014-0818	Tubefork PLCC 28/ 32 Socket	17.9 - 18.1	17.9 - 27.0	2.5	20.0	5
L-014-0815	Tubefork PLCC 44 Socket	22.8 - 23.3	22.8 - 27.5	2.5	25.0	5
L-014-0822	Tubefork PLCC 68 Socket	30.7 - 31.2	30.7 - 37.5	2.5	33.0	7
L-014-0812	Tubefork PLCC 84 Socket	35.0 - 36.3	35.0 - 40.0	2.5	38.0	9
L-014-0821	Tubefork SOJ 28	8.3 - 8.8	18.0 - 30.0	0.6	15.5	5
L-014-0810	Tubefork SO32	14.3 - 14.8	30.5 - 41.0	1.6	20.5	5
L-014-0819	Tubefork SO24	7.6 - 8.1	17.0 - 28.5	1.0	16.5	5
L-014-0820	Tubefork SO24/33 Wide Stick	11.8 - 12.3	17.0 - 30.5	1.0	20.5	5
L-014-0840	Tubefork SOL 28	11.3 - 11.8	17.0 - 27.0	1.0	16.0	5
L-014-0832	Tubefork SOP 8	6.1 - 6.6	6.0 - 7.5	0.8	9.7	3
L-014-0830	Tubefork SOP 14	7.6 - 8.1	10.0 - 16.0	0.8	11.3	3
L-014-0831	Tubefork SOP 14 Wide Stick	7.6 - 8.1	10.0 - 16.0	0.8	13.1	3
L-014-0828	Tubefork SOP 16, QSOP 16	6.3 - 6.8	8.0 - 13.5	0.7	9.5	3
L-014-0839	Tubefork SOP 32	13.8 - 14.3	20.0 - 30.0	1.1	20.0	5
L-014-0813	Tubefork SOJW 32	10.8 - 11.3	20.0 - 33.5	0.6	14.5	5
L-014-0814	Tubefork SOJW 32 Wide Stick	11.1 - 11.6	20.0 - 34.5	0.9	18.0	5
L-014-0823	Tubefork VSO 32	13.9 - 14.4	20.0 - 34.5	0.9	18.5	5
L-014-0824	Tubefork D-Pack	9.7 - 10.2	14.0 - 20.0	0.9	20.0	5
L-014-0826	Tubefork for Connector	6.7 - 7.2	17.0 - 27.0	0.6	9.8	3
L-014-0827	Tubefork for Battery Contact	9.5 - 10.0	13.0 - 23.0	2.0	13.8	5
L-014-0829	Tubefork for Amp 15	12.5 - 13.0	18.0 - 29.0	1.1	16.5	5
L-014-0077	Stick Stopper 9.5/4.5 - VM30					

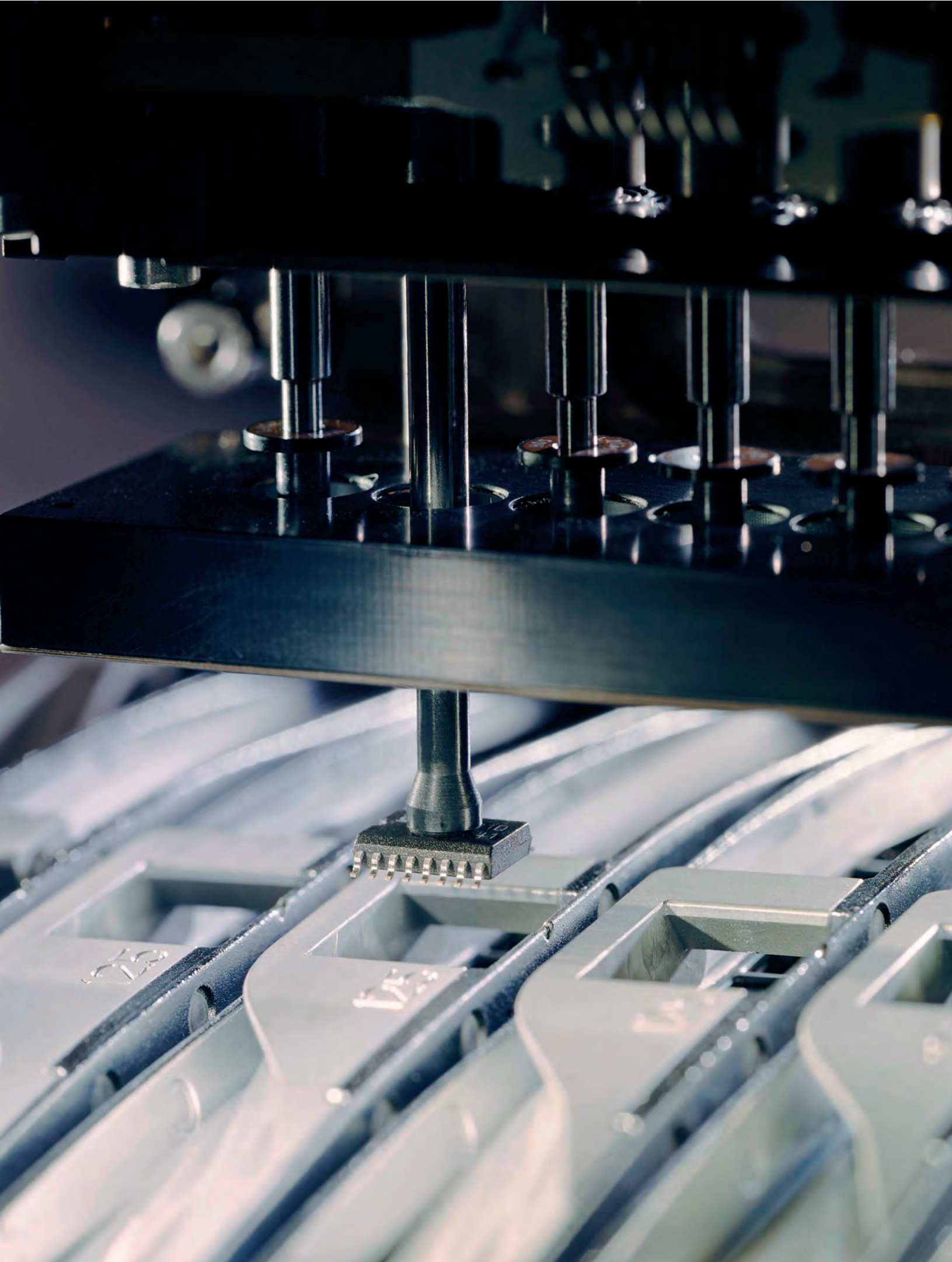

Placement Tools

MYDATA provides a wide variety of tools for component placement.

Components are handled delicately with Intelligent Surface Impact Control or ISIC. This is a sophisticated servo system for Z-axis movements which ensures that even the most delicate components are handled with complete safety. It ensures that exactly the same placement force is applied to all components on the board of the same package type. Different packages, of course, have different preset placement forces.

The machines normally can handle up to 26 tools for the single-nozzle head, and up to 64 tools for the multi-nozzle head. Each tool and each tool slot is coded to ensure that each tool is stored in the right tool slot. During machine operation, tool exchange occurs automatically.

The choice of tool to use depends on the maximum internal diameter of the tip. This must not exceed the width of the pick area on the component. For special or odd-shaped components, MYDATA can custom-design a placement or glue tool.

Tool B12 chip 01005

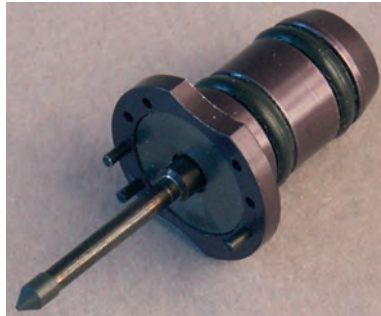

Description
 Spring-suspended tool with tip measuring 0.13 mm (0.0051") internal diameter, 0.45 mm (0.018") outer diameter. Insulated. Colour: black.
 Typical component types: 01005, 0201*. A set of 3 replacement tool tips is included.
 * Tool C14 is recommended.

Spare part tool tip: L-012-0885 Set of 3 tool tips B12

Machine type:
 MY9 , MY12 , MY15 , MY19

Part no.	Product name
L-012-0884	Tool B12 chip 01005

Tool C14



Description
 Spring-suspended tool with tip measuring 0.25 mm (0.0098") internal diameter. Insulated. Colour: black.
 Typical component types: 0201, 0402, 0603.

Spare part tool tip: L-012-0823 (kit with 3pcs)

Machine type:
 TP9-1 , TP9-2 , TP9-3 , TP9-4 , TP11 , TP12 , TP18 , MY9 , MY12 , MY15 , MY19

Part no.	Product name
L-012-0802	Tool C14

Tool A12



Description
 Spring-suspended tool with 0.8 mm (0.0315") internal diameter tip. Insulated. Colour black.
 Typical component types: 0603, 0805, SOT-23.

Spare part tool tip: D-012-0263D-4

Machine type:
 MY12 , MY15 , MY19 , MY9 , TP11 , TP12 , TP18 , TP9-1 , TP9-2 , TP9-3 , TP9-4

Part no.	Product name
L-012-0011E	Tool A12

Tool A13



Description
 Spring-suspended tool with 1.2 mm (0.0472") internal diameter tip. Colour black.
 Typical component types: 1206, 1812, SOT-89.

Spare part tool tip: D-012-1162

Machine type:
 TP9-1 , TP9-2 , TP9-3 , TP9-4 , TP11 , TP12 , TP18 , MY9 , MY12 , MY15 , MY19

Part no.	Product name
L-012-0012F	Tool A13

Tool A14S



Description
Spring-suspended tool with 2.0 mm (0.0787") internal diameter tip. Insulated. Colour black.
Typical component types: SO-8, SO-16, SOMC-16.

Spare part tool tip: D-012-0408B

Part no.	Product name
L-012-0109C	Tool A14S

Tool A23



Description
Stiff tool with 3.0 mm (0.1181") internal diameter tip. Insulated. Colour black. Not exchangeable tool tip. Typical component types: SO-18, SO-20, Flat Pack-80.

Machine type:
MY12 , MY15 , MY19 , MY9 , TP11 , TP12 , TP18 , TP9-1 , TP9-2 , TP9-3 , TP9-4

Part no.	Product name
L-012-0014D	Tool A23

Tool A23S



Description
Spring-suspended tool with 3.0 mm (0.1181") internal diameter tip, including spare tip and puller for tip replacement. Insulated. Colour black. Typical component types: SO-18, SO-20, Flat Pack-80.

Additional spare part tool tips: L-012-0540

Part no.	Product name
L-012-0551B	Tool A23S

Tool A24



Description
Stiff tool with 5.0 mm (0.1968") internal diameter tip. Insulated. Colour black. Not exchangeable tool tip. Typical component types: LCCC, PLCC, QFP.

Machine type:
MY12 , MY15 , MY19 , MY9 , TP11 , TP12 , TP18 , TP9-1 , TP9-2 , TP9-3 , TP9-4

Part no.	Product name
L-012-0015D	Tool A24

Tool A24S



Description
Spring-suspended tool with 5.0 mm (0.1968") internal diameter tip, including spare tip and puller for tip replacement. Insulated. Colour black. Typical component types: LCCC, PLCC, QFP.

Additional spare part tool tips: L-012-0542

Part no.	Product name
L-012-0552B	Tool A24S

Tool C23S



Description
8 mm (0.315") internal diameter tip, insulated spring-suspended tool. For large components mounted with optical centering.

Spare part tool tips: L-012-0381B

Part no.	Product name
L-012-0383C	Tool C23S

Tool C23



Description
Stiff tool with 8 mm (0.315") internal diameter tip. Insulated. Colour black. Not exchangeable tool tip. For large components mounted using optical centering.

Machine type:
MY12 , MY15 , MY19 , MY9 , TP11 , TP12 , TP18 , TP9-1 , TP9-2 , TP9-3 , TP9-4

Part no.	Product name
L-012-0026D	Tool C23

Tool A34



Description
Spring-suspended MELF tool with 1.5 mm tip (0.0590"). Insulated. Colour black. Typical component type: MINIMELF.

Spare part tool tip: D-012-0308C

Machine type:
MY12 , MY15 , MY19 , MY9 , TP11 , TP12 , TP18 , TP9-1 , TP9-2 , TP9-3 , TP9-4

Part no.	Product name
L-012-0016E	Tool A34

Tool B34



Description
Spring-suspended MELF tool with 2.0 mm (0.0787") tip. Insulated.
Colour black.
Typical component type: MELF.

Spare part tool tip: D-012-0404C

Machine type:
MY12 , MY15 , MY19 , MY9 , TP11 , TP12 , TP18 , TP9-1 , TP9-2 ,
TP9-3 , TP9-4

Part no.	Product name
L-012-0022E	Tool B34

Tool B23



Description
Spring-suspended MELF tool with 2.5 mm (0.0984") tip. Insulated.
Colour black.
Typical component type: SOD80.

Spare part tool tip: D-012-0248D

Machine type:
MY12 , MY15 , MY19 , MY9 , TP11 , TP12 , TP18 , TP9-1 , TP9-2 ,
TP9-3 , TP9-4

Part no.	Product name
L-012-0020E	Tool B23

Tool B24



Description
Spring-suspended MELF tool with 2.3 mm (0.0906") tip. Insulated.
Colour black.
Typical component type: MELF.

Spare part tool tip: D-012-0255D

Machine type:
MY12 , MY15 , MY19 , MY9 , TP11 , TP12 , TP18 , TP9-1 , TP9-2 ,
TP9-3 , TP9-4

Part no.	Product name
L-012-0021E	Tool B24

Tool C24 flat nozzle 3.5 mm x 1.0 mm



Description
Nozzle Outer Dimensions:
3.5 mm x 1.0 mm
Typical components: Connectors.

Machine type:
TP9-1 , TP9-2 , TP9-3 , TP9-4 , TP11 , TP12 , TP18 , MY9 , MY12 ,
MY15 , MY19

Part no.	Product name
L-012-0845	Tool C24 flat nozzle 3.5 mm x 1.0 mm

Tool C24 flat nozzle 5.0 mm x 1.0 mm



Description
 Nozzle Outer Dimensions
 5.0 mm x 1.0 mm.
 Typical components: Connectors.

Machine type:
 TP9-1 , TP9-2 , TP9-3 , TP9-4 , TP11 , TP12 , TP18 , MY9 , MY12 ,
 MY15 , MY19

Part no.	Product name
L-012-0846	Tool C24 flat nozzle 5.0 mm x 1.0 mm

Tool C24 melf 3.3



Description
 Tool tip curve radius 1.65 mm, tool outer diameter = 4 mm,
 insulated.
 Typical components: Small MELFs, Diodes.
 Component size: Outer diameter 3.3 mm

Spare part tool tip: D-012-0857

Machine type:
 TP9-1 , TP9-2 , TP9-3 , TP9-4 , TP11 , TP12 , TP18 , MY9 , MY12 ,
 MY15 , MY19

Part no.	Product name
L-012-0848	Tool C24 melf 3.3

Tool C24 flat nozzle 7.2 mm x 1.2 mm



Description
 Nozzle Outer Dimensions
 7.2 mm x 1.2 mm.
 Typical component: Connectors.

Machine type:
 TP9-1 , TP9-2 , TP9-3 , TP9-4 , TP11 , TP12 , TP18 , MY9 , MY12 ,
 MY15 , MY19

Part no.	Product name
L-012-0847	Tool C24 flat nozzle 7.2 mm x 1.2 mm

Tool C24 melf 4.5



Description
 Tool tip curve radius 2.25 mm, tool outer diameter = 4 mm,
 insulated.
 Typical components: Medium-size MELFs, Diodes.
 Component size: Outer diameter 4.5 mm

Spare part tool tip: D-012-0879

Machine type:
 TP9-1 , TP9-2 , TP9-3 , TP9-4 , TP11 , TP12 , TP18 , MY9 , MY12 ,
 MY15 , MY19

Part no.	Product name
L-012-0849	Tool C24 melf 4.5

Tool C24 melf 7.7



Description
Tool tip curve radius 3.5 mm, tool outer diameter = 3 mm, insulated.

Typical component: Medium-size MELFs, Diodes.
Component size: Outer diameter 7.7 mm.

Spare part tool tip: D-012-0284-4

Machine type:
TP9-1 , TP9-2 , TP9-3 , TP9-4 , TP11 , TP12 , TP18 , MY9 , MY12 , MY15 , MY19

Part no.	Product name
L-012-0850	Tool C24 melf 7.7

Set of 8 Tools H01 Rev.1

Description
HYDRA Tool H01 (white), OD=1.2mm, ID=0.5mm.
Component range 0402-1206(-6).

Requirements:
HYDRA 14.4K

Part no.	Product name
L-012-0513	Set of 8 Tools H01 Rev.1

Set of 8 Tools H02 Rev.1

Description
HYDRA Tool H02 (yellow), OD=1.5mm, ID=0.7mm.
Component range 0603-1210 and smaller SOIC-components.

Requirements:
HYDRA 14.4K

Part no.	Product name
L-012-0514	Set of 8 Tools H02 Rev.1

Set of 8 Tools H03 Rev.1

Description
HYDRA Tool H03 (red), OD=3 mm, ID=1 mm.

Component range 1206-2512 chip-components, SC59-, SO8-, SO14-, SOT89, SOT223-, SSOP20-, SSOP24-, SSOP28-components, Molded Tantalum Capacitor A-6032 and A-7343).

Requirements:
HYDRA 14.4K

Part no.	Product name
L-012-0520	Set of 8 Tools H03 Rev.1

Set of 8 Tools H01 Rev.2



Description
HYDRA Tool H01 (white), OD=1.2mm, ID=0.5mm.
Component range 0402-1206(-6).

Requirements:
HYDRA 21K

Part no.	Product name
L-012-0533	Set of 8 Tools H01 Rev.2

Set of 8 Tools H02 Rev.2



Description
HYDRA Tool H02 (yellow), OD=1.5mm, ID=0.7mm.
Component range 0603-1210 and smaller SOIC-components.

Requirements:
HYDRA 21K

Part no.	Product name
L-012-0534	Set of 8 Tools H02 Rev.2

Set of 8 Tools H03 Rev.2



Description
 HYDRA Tool H03 (red), OD=3 mm, ID=1 mm.
 Component range 1206-2512 chip-components, SC59-, SO8-, SO14-, SOT89, SOT223-, SSOP20-, SSOP24-, SSOP28-components, Molded Tantalum Capacitor A-6032 and A-7343).

Requirements:
 HYDRA 21K

Part no.	Product name
L-012-0535	Set of 8 Tools H03 Rev.2

Set of 8 Tools H04



Description
 HYDRA Tool H04 (blue) OD = 1.5 mm, ID = 0.9 mm.
 Component range 0603-1206 chip component.
 MELF3514, SOD-80

Requirements:
 HYDRA 21K

Part no.	Product name
L-012-0572	Set of 8 Tools H04

Set of 8 Tools H05



Description
 HYDRA Tool H05 (brown), OD=5.2 mm, ID=2.8 mm.
 Max component size: 15x15mm tip-to-tip with HYDRA 21k ER LVS, typically SO16/20/24.

Machine type:
 HYDRA

Requirements:
 HYDRA 21K ER LVS

Part no.	Product name
L-012-0824	Set of 8 Tools H05

Set of 8 tools H06



Description
 HYDRA Tool H06 (green), OD=0.6mm, ID=0.25mm.
 Component range 0201, (0402)* chip.
 * Tool H01 is recommended.

Machine type:
 HYDRA

Requirements:
 For 0201 chip mounting: MY-series machine, Hydra 2D, Agilis LM8, Agilis Feeder 8, 3.7 or 4.0, TPsys 2.4, Linescan Vision System, LVS

Part no.	Product name
L-012-0816	Set of 8 tools H06

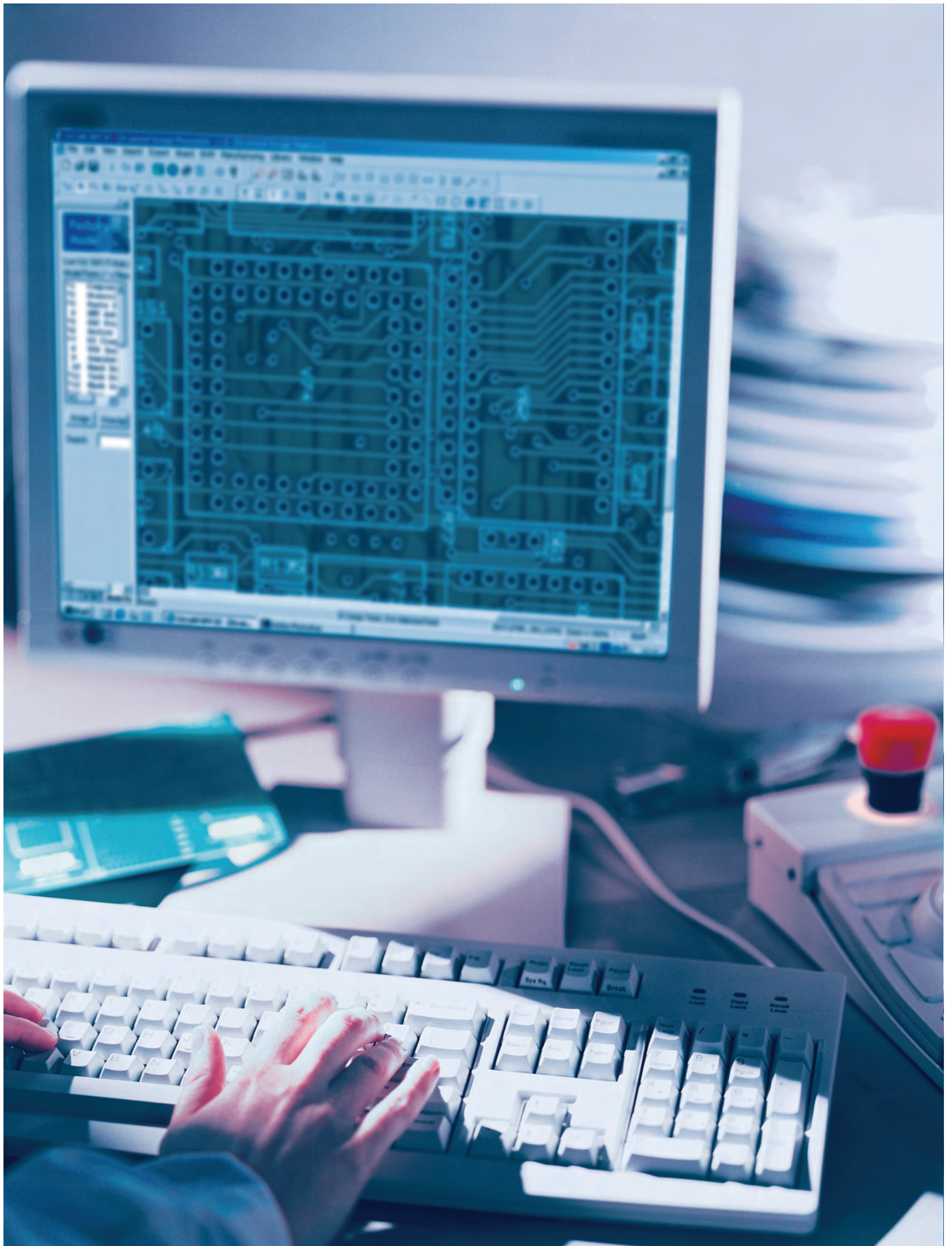

Software Products and Options

The MYDATA Assembly Process Management (APM) software suite comprises of a group of products that can be used to fully automate the process of building a PCB - from CAD drawing to assembly. Linking your machines together and integrating them into the existing network in your production plant has benefits that extend beyond the factory floor throughout the company.

The APM suite includes:

- * MYCam, which dramatically cuts down machine programming time and guarantees programming accuracy.
- * TPSys Shared Databases, for making all production information accessible to all machines from one place and for moving jobs easily between machines. It improves performance, means more flexibility, and gives easier instant file access and seamless data sharing.
- * MYPlan, the production streamlining and planning program, offers real line balancing and suggests the optimal feeder configurations to achieve the highest possible outputs.
- * MYLabel simplifies the component loading process to the scanning of just two barcodes, and keeps track of component quantities.

TPSys Linux Software

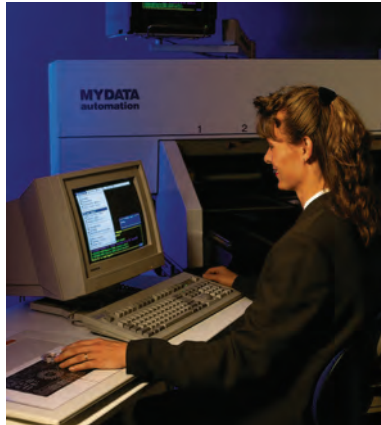

Description

For upgrading a MYDATA machine to TPSys 2.5. See order guide P-040-0018C for details.

- Automatic illumination settings
- Quick-links between editors
- Calibration management system
- Share fi ducials between machines
- HYDRA™ pick from trays
- Machine performance report
- Component availability warning
- Faster Midas™ tool change
- Image log with thumbnails
- Improved TEX™ optimization

Requirements:

TP-Series machine with s/n 9268 or later, or MY-Series machine.

Part no.	Product name
L-040-0127D	TPSys 2.5 Upgrade Kit
03230	Upgrade step from SYS 2.9 (9268 & above)
03231	Upgrade step from TPSys 1.3/1.4
03232	Upgrade step from TPSys 1.6/1.5
03233	Upgrade step from TPSys 2.0
03234	Upgrade step from TPSys 2.1
03235	Upgrade step from TPSys 2.2
03236	Upgrade step from TPSys 2.3
03237	Upgrade step from TPSys 2.4
03640	AT-CPU1 PF2 with CP54
03641	AT-CPU2 PF2 with CP54
03642	AT-CPU2 PF2 with CP5
03670	2 Monitors
03671	3 Monitors

TPSys Unix Software

Description

For upgrading a MYDATA TP-Series machine to TPSys 1.6. Choose the appropriate option or options according to your needs.

Ordering info:

Choose from 0324 or 0325 depending on your machine's current software and hardware.

Part no.	Product name
L-040-0125	TPSys 1.6 Upgrade Kit TP
0324	Upgrade step from TPSys 1.3/1.4
0325	Upgrade step from TPSys 1.5/1.6

PC Server TPSys 2.x With UPS

Description

A dedicated stand-alone PC gives faster database response when it is used as the server for shared databases. When two or more machines are to be networked, it is recommended that the stand-alone server be used. With a stand-alone server, each networked machine can still retain its local database and independence.

The UPS (Uninterrupted Power Supply) ensures that the server can be shut down in a controlled manner, in case of a power failure.

Machine type:

MY12 , MY15 , MY19 , MY9 , TP11 , TP12 , TP18 , TP9-1 , TP9-2 , TP9-3 , TP9-4

Requirements:

For 230V or 120V power supply, TPSys 2.0 or later. Shared databases.

Ordering info:

Please state voltage and TPSys version when ordering.

Part no.	Product name
L-010-0270	PC Server TPSys 2.x With UPS

MYLabel 4 Kit w Cordless Scanners



Description

Lower your risk of error and reduce setup and changeover times with MYLabel. Instead of manually entering component and feeder information, MYLabel simplifies the loading process to just two barcode scans per reel.

MYLabel enables users to effortlessly keep track of remaining component quantities and batch codes. All information is updated from the latest statistical production data, so the user will always know if a tape reel has enough components on it for the next job.

This kit contains:
 1x MYLabel 4.x box with CD and manual
 2x Hardware key
 2x L-010-0377 Barcode scanner cordless (Bluetooth radio, universal voltage)
 1x L-010-0383 Label printer (universal voltage)
 1x L-010-0386 Box of labels (53x55 mm, 18 rolls)

Requirements:
 TPSys: • TPSys 2.4 or 2.5 • TPSys Shared Databases (if more than one machine is used) • PC Server L-010-0270 (if more than two MYLabel stations or more than two machines are used) • Note: the TPSys Barcode SW option is not necessary (and not recommended) together with MYLabel. Computer: • 400 MHz processor or faster • Windows XP SP2 • TCP/IP network between PC and dataser/machine • USB port for hardware key • USB port for cordless (Bluetooth) scanner • USB port for label printer

Part no.	Product name
L-010-0395	MYLabel 4 Kit w Cordless Scanners

MYLabel 4 Software



Description
 Lower your risk of error and reduce setup and changeover times with MYLabel. Instead of manually entering component and feeder information, MYLabel simplifies the loading process to just two barcode scans per reel.

MYLabel enables users to effortlessly keep track of remaining component quantities and batch codes. All information is updated from the latest statistical production data, so the user will always know if a tape reel has enough components on it for the next job.

This kit contains:
 1x MYLabel 4.x box with CD and manual
 1x Hardware key

Requirements:
 TPSys: • TPSys 2.4 or 2.5 • TPSys Shared Databases (if more than one machine is used) • PC Server L-010-0270 (if more than two MYLabel stations or more than two machines are used) • Note: the TPSys Barcode SW option is not necessary (and not recommended)

together with MYLabel. Computer: • A PC with the following specification and accessories is required: - 400 MHz processor or faster - Windows XP SP2 - TCP/IP network between PC and dataser/machine - USB port for hardware key - Label printer - Barcode scanner with COM-port interface Other • Magazine barcode labels for TM and VMF magazines

Part no.	Product name
L-010-0470	MYLabel 4 Software

Barcode Scanner Cordless



Description
 Datalogic Gryphon BT Bluetooth Scanner with Bluetooth-USB adapter, battery charger and universal power supply (100-240V, 50-60Hz, EU, US, and UK plugs).

Requirements:
 USB port

Part no.	Product name
L-010-0377	Barcode Scanner Cordless

Barcode Scanner RS232



Description
 Datalogic Gryphon D120 Barcode Scanner with RS232 cord and universal power supply (100-240V, 50-60Hz, EU, US, and UK plugs).

Requirements:
 9-pin RS232 port (COM port)

Part no.	Product name
L-010-0380	Barcode Scanner RS232

Label Printer for MYLabel



Description
 Zebra LP2824 Label Printer with USB cable and universal power supply (100-240V, 50-60Hz, EU, US, and UK plugs).

Requirements:
 USB port. Labels (for example L-010-0386).

Part no.	Product name
L-010-0383	Label Printer for MYLabel

Labels 53x55mm - Case of 18 rolls



Description
 Direct thermal, no ribbon required. Size 53x55 mm (W x H).

Requirements:
 Zebra LP2824 Label Printer

Part no.	Product name
L-010-0386	Labels 53x55mm - Case of 18 rolls

MYLabel 4 Upgrade from 2.X



Description
 New in MYLabel 3.0

- Load and unload trays using Position barcodes
- Fully utilize supplier's barcode label for keyboardless operation

- Action barcodes for Print, Discard, etc.
- Unload all feeders in magazine with just two scans

New in MYLabel 4.0

- Floor life timer for moisture sensitive devices (MSDs)
- Component location tracking using location barcode sticker
- Support for TPSys 2.5

Requirements:
 MYLabel 2.X. TPSys 2.4 or 2.5.

Part no.	Product name
L-010-0397	MYLabel 4 Upgrade from 2.X

MYLabel 4 Upgrade from 3.X



Description
 New in MYLabel 4.0

- Floor life timer for moisture sensitive devices (MSDs)
- Component location tracking using location barcode sticker

- Support for TPSys 2.5

Requirements:

MYLabel 3.X. TPSys 2.4 or 2.5.

Part no.	Product name
L-010-0398	MYLabel 4 Upgrade from 3.X

MYPlan Single Job Optimization

Description

MYPlan Single Job calculates the best strategy when changing over from a job that is currently running, to a new one. The current magazine content is automatically downloaded over the network, and MYPlan will then help you select the best changeover strategy based on batch size, feeder reloading time, and machine throughput. For a short batch, MYPlan can minimize the time spent on feeder loading, while a larger batch will benefit from a completely new, optimized kitting.

The result is presented in a step-by-step changeover instruction, that guides the operator through the changeover process. Components not found in any magazines are presented in a pick list with barcoded partnumbers that can be used for pre-kitting the magazine bins in the stock room. The optimized mount program is transferred over the network directly to the machines or the TPSys data server. MYPlan Single Job works with either a standalone machine, or a line consisting of up to five machines.

Requirements:

TPSys 2.4 or later. A PC running Windows 2000/XP. Shared databases and PC Server (if more than one machine).

Part no.	Product name
L-010-0521	MYPlan Single Job Optimization

MYPlan Multi Job Optimization

Description

MYPlan Multi Job will automatically select and optimize a number of jobs that are suitable to run together in a "family", based on part commonality. The jobs are selected from a list of candidates, and before the optimization step, one or several jobs may be marked as "high priority". All high priority jobs, and as many low priority jobs as possible, will be grouped together, and a "family kit" will then be created containing all components necessary to run these jobs with zero feeder loading in between. The software can also be used to create a fixed setup for a number of frequently recurring jobs.

The result is presented in a step-by-step changeover instruction, that guides the operator through the changeover process. Components not found in any magazines are presented in a pick list with barcoded partnumbers that can be used for pre-kitting the magazine bins in the stock room. The optimized mount program is transferred over the network directly to the machines or the TPSys data server. MYPlan Multi Job works with either a standalone machine, or a line consisting of up to five machines. All functionality in MYPlan Single Job (L-010-0521) is also included in the Multi Job version.

Requirements:

TPSys 2.4 or later. A PC running Windows 2000/XP. Shared databases and PC Server (if more than one machine).

Part no.	Product name
L-010-0522	MYPlan Multi Job Optimization

CAD Conversion

Description

Converts any CAD file to MYDATA TPSys format by using the center point when defining a package. The software comes complete with several control files to suit a range of CAD systems (a control file converts the input CAD file to the output TPSys file). If none of the included control files suit the customers' CAD system, MYDATA will assist the customer in creating one specific control file.

Requirements:

CAD Conversion software is intended to run on a desktop PC under Windows 95/98/NT/2000/XP. One free USB port needed for the hardware key.

Part no.	Product name
L-020-0090-4.0	CAD Conversion 4.0
L-020-0091-4.0	CAD Conversion 4.0 upgrade from 3.X

MYCam, All Import Interfaces

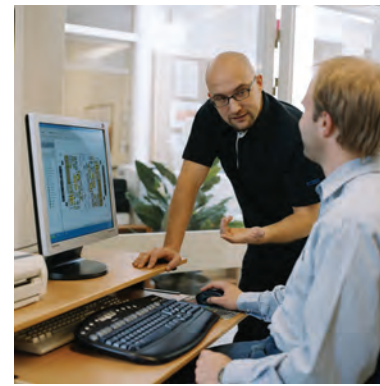

Description

Off-line programming software to process all supported CAD files and BOM data into complete machine programs quickly, easily, and accurately.

The package includes:

- Basic module.
- MYDATA output interface.
- All CAD Import Interfaces and all Machine Import Interfaces.
- 12 months of free upgrades.

MYCam communicates with either an individual MYDATA machine or a shared database server. Depending on the TPSys version, the following capabilities will be available:

TPSys 1.4 or earlier: directline output, directline component import.

TPSys 1.5 or 1.6: output TPSys program files, import all TPSys libraries.

TPSys 2.0 or later: output TPSys files and libraries, import all TPSys libraries.

Available in English, German & French. Manual is in English.

Requirements:

Minimum system requirements: Windows 2000/XP, 64MB RAM, 20MB harddisk space, 800x600 pixel display, CD-ROM. LAN and Internet access recommended.

Part no.	Product name
K-040-0005	MYCam, All Import Interfaces

MYCam Main Software Systems

Description

Off-line programming software to process a single CAD source and BOM data into complete machine programs quickly, easily, and accurately.

The package includes:

- Basic module.
- MYDATA output interface.
- One CAD importer
- 12 months of free upgrades.

MYCam communicates with either an individual MYDATA machine or a shared database server. Depending on the TPSys version, the following capabilities will be available:

TPSys 1.4 or earlier: directline output, directline component import.

TPSys 1.5 or 1.6: output TPSys program files, import all TPSys libraries.

TPSys 2.0 or later: output TPSys files and libraries, import all TPSys libraries.

Available in English, German & French. Manual is in English.

Requirements:

Minimum system requirements: Windows 2000/XP, 64MB RAM, 20MB harddisk space, 800x600 pixel display, CD-ROM. LAN and Internet access recommended.

Part no.	Product name
K-040-0301	MYCAM + ACCEL EDA TANGO PCAD
K-040-0302	MYCAM + TANGO FOR DOS IMPORT
K-040-0304	MYCAM + CADENCE ALLEGRO IMPORT
K-040-0306	MYCAM + C-LINK DIF IMPORT
K-040-0307	MYCAM + EE DESIGNER 3 IMPORT
K-040-0308	MYCAM + FABMASTER CAD IMPORT
K-040-0309	MYCAM + GENCAD V. 1.4 IMPORT
K-040-0311	MYCAM + INCASES CAD IMPORT
K-040-0312	MYCAM + INTERGRAPH PANTHEON
K-040-0313	MYCAM + INTERGRAPH VERIBEST

Part no.	Product name
K-040-0315	MYCAM + MENTOR GRAPHICS IMPORT
K-040-0317	MYCAM + ORCAD IMPORT
K-040-0318	MYCAM + PADS POWERPCB ETC
K-040-0319	MYCAM + PANAPRO PCB IMPORT
K-040-0320	MYCAM + PCAD PDIF IMPORT
K-040-0321	MYCAM + PROTEL CAD IMPORT
K-040-0323	MYCAM + SCI CARDS IMPORT
K-040-0324	MYCAM + SUBCONTRACTORS PACKAGE
K-040-0325	MYCAM + SUPERMAX CAD IMPORT
K-040-0326	MYCAM + TECNOMATIX-UNICAM PDW IMPORT
K-040-0327	MYCAM + THEDA INCASES IMPORT
K-040-0328	MYCAM + ULTIBOARD CAD IMPORT
K-040-0329	MYCAM + VALOR ODB++ IMPORT
K-040-0330	MYCAM + ZUKEN VISULA + CADSTAR
K-040-0338	MYCAM + MACHINE IMPORT SUITE

MYCam Documentation

Description

The MYCam Documentation Module creates assembly and inspection documents automatically, greatly increases the quantity and quality of documentation on the floor, while also increasing the speed of release to production initially, and following engineering changes.

MYCam Documentation creates visual aids using color-coded blocks, pictures, hyperlinks, and OLE objects. The Windows' Clipboard function is supported, which allows a user to copy and paste the created visual aids into another Windows application such as Microsoft Word. This module is workgroup-capable in that fully automatic templating of visual aid formats can be shared across many MYCam users and factories.

Part no.	Product name
K-040-0009	MYCam Documentation

MYCam Viewer

Description

Paperless document station licenses for your plant floor with MYCam's ViewPort modules. The ViewPort GUI has a similar layout to MYCam. However, it does not permit for your operators to modify, update, or create project files, as the functionality found in MYCam is not accessible within this environment. Your plant floor personnel will be able to interact with the visual aids when you incorporate video, audio, and hyperlinks to the view. Hyperlinks can be associated to both text entries and part numbers found on the board layout.

Part no.	Product name
K-040-0010	MYCam Viewer

MYCam Viewer Site License

Description

Unlimited MYCam Viewer licenses that can be used concurrently within one factory/building.

Part no.	Product name
K-040-0063	MYCam Viewer Site License

MYCam Reporting System

Description

Print various reports supported in MYCam. The reports include DPMO, Component Routing, and Component Prep (lead forming). It also permits you to print color-coded labels for part bins to match the color block on the visual aids. This requires Microsoft Access97 (Access2000 does not support this function).

Part no.	Product name
K-040-0011	MYCam Reporting System

Network License Manager

Description

The network license manager enables a single PC to administrate an entire network of Aegis products.

Part no.	Product name
K-040-0217	Network License Manager

MYCam Multiple User Licenses

Description

Provides licensing rights for an extra concurrent user. Additional user licenses inherit the options of the first user license within one facility. Therefore, no additional module purchases are necessary for licenses beyond the first. An individual license control "key" is provided for attachment to the parallel port of the PC upon which CircuitCAM will be used. This key may be moved from one PC to another.

Part no.	Product name
K-040-0064	MYCam 2nd License
K-040-0065	MYCam 3rd License
K-040-0066	MYCam 4th License
K-040-0067	MYCam 5th License
K-040-0068	MYCam 6th License

MYCam CAD Import Interfaces



Description

Individual importer for board design and layout information such as native CAD files, Gerber, centroid CAD, or scanned boards.

Part no.	Product name
K-040-0024	CAD Accel PCAD, Tango, EDA Imp
K-040-0025	CAD Tango for DOS
K-040-0027	CAD Cadence Allegro
K-040-0016	CAD C-Link DIF
K-040-0098	CAD EE Designer 3 Import
K-040-0129	CAD Fabmaster Import
K-040-0018	CAD GenCAD v1.4
K-040-0110	CAD Incases Import
K-040-0031	CAD Intergraph Pantheon Design
K-040-0029	CAD Intergraph Veribest GenCAD
K-040-0021	CAD Mentor Graphics
K-040-0028	CAD OrCAD Import
K-040-0020	CAD PADS PowerPCB, Perform, 2000, Work
K-040-0023	CAD PCAD Import
K-040-0026	CAD Protel Import
K-040-0111	CAD SCI Cards Import
K-040-0013	CAD Subcon's Pckg (Gerber + ASCII Import)
K-040-0107	CAD Technomatix-Unicam WF Imp
K-040-0070	CAD THEDA BY INCASES
K-040-0071	CAD ULTIBOARD
K-040-0108	Upgrade from one CAD to all CAD imports
K-040-0109	CAD Valor ODB++ Import
K-040-0022	CAD Zuken Visula and Cadstar
K-040-0143	CAD Panapro PCB Import
K-040-0144	CAD Supermax
K-040-0069	All CAD Import Formats

MYCam Machine Imports



Description

Individual machine format importer.

Part no.	Product name
K-040-0112	CAD Contact Systems CS3 Import
K-040-0113	CAD Europlacer Import
K-040-0115	CAD Fuji Source Program Import
K-040-0116	CAD Panasonic POS Import
K-040-0114	CAD Philips FTIP-1 Import
K-040-0118	CAD Sanyo/Universal Chipsh Im
K-040-0117	CAD Siemens Program Import
K-040-0032	All Machine Import Formats

MYCam Machine Programming Interfaces



Description

Part no.	Product name
K-040-0221	Accuflex Screen Printer Interface
K-040-0081	Amistar Axial Inserter
K-040-0033	Amistar Coordinate Download
K-040-0082	Amistar DIP Inserter
K-040-0034	ASCII Custom Output Interface
K-040-0222	Assembleon FCM/ACM Interface
K-040-0223	Assembleon GEM LINE Interface
K-040-0083	Asymtek Dispensing Interface
K-040-0176	Autosplice Programming Interface
K-040-0072	Camalot Full Line Disp Interface
K-040-0035	Celmacs Interface
K-040-0085	Christopher AOI Interface
K-040-0036	Citizen Interface
K-040-0037	Contact Systems 3S/3AV Interface
K-040-0057	Contact Systems 3Z Series Interface
K-040-0038	Contact Systems CS-400 Interface
K-040-0086	CR Technologies AOI Interface
K-040-0087	Dynapert Axial Inserter
K-040-0088	Dynapert DIP Inserter
K-040-0039	Dynapert I-2200 Interface
K-040-0040	ECM 96 Interface
K-040-0145	Ekra screen printer interface
K-040-0073	Europlacer Interface
K-040-0146	Fuji F4G
K-040-0147	Fuji Source Program Interface
K-040-0177	Fuji Flexa Interface
K-040-0090	GenCAD Export Module
K-040-0076	GenCAD Export Output Fujicam
K-040-0148	GPD Adhesive Dispensing Interface
K-040-0225	Heller Oven Interface
K-040-0091	Intelligent Reas Sys AOI Interface
K-040-0042	Intelliplace Interface
K-040-0149	Juki HLC/2000 Series Interface
K-040-0092	KME Chipshooter Interface
K-040-0153	KME PS245 Interface
K-040-0093	Machine Vision Prod AOI Interface
K-040-0154	MIMOT SMT Interface
K-040-0043	MPI/Manix Interface
K-040-0048	MPM400-500/SMTech Printers
K-040-0044	Multitronics Interface
K-040-0226	MYDATA Machine Interface
K-040-0094	Orbotech AOI Interface
K-040-0150	Omron AOI Machine Interface
K-040-0120	Panasonic Panasert Interface
K-040-0045	Philips Ind. Aut. Via FTIP-2
K-040-0151	Royonix Machine Interface
K-040-0059	Quad AVX Printer Prog Interface
K-040-0046	Quad Systems Interface
K-040-0095	Samsung Interface
K-040-0047	Sanyo TCM Chipshooter Interface
K-040-0060	Sanyo TIM Flexible Plac. Interface

Part no.	Product name
K-040-0075	Siemens HS Series Interface
K-040-0074	Siemens Siplace Interface
K-040-0155	Siemens SIPLACE PRO Interface
K-040-0121	Speedline/MPM/Quad AVX/SMTech
K-040-0061	TDK Interface
K-040-0184	Takaya Flying Probe/Fixture List Interface
K-040-0049	Test Fixture Coordinate Output
K-040-0052	Universal GSM Interface
K-040-0050	Universal Instr Axial VCD INS
K-040-0053	Universal Instr Multimod (DIP)
K-040-0054	Universal Instr Radial Ins
K-040-0051	Universal Instr Chipshooter
K-040-0157	Universal Advanced Multimod DIP Interface
K-040-0156	Universal Advanced Axial Inserter Interface
K-040-0185	UMG Odd Form Placement Interface
K-040-0062	VI Technology AOI Machine Interface
K-040-0158	XYFLEX PRO Adhesive Dispenser Interface
K-040-0224	Yestech AOI Interface
K-040-0055	Zevatech/Juki 500 Interface
K-040-0056	Zevatech/Juki 700 Interface

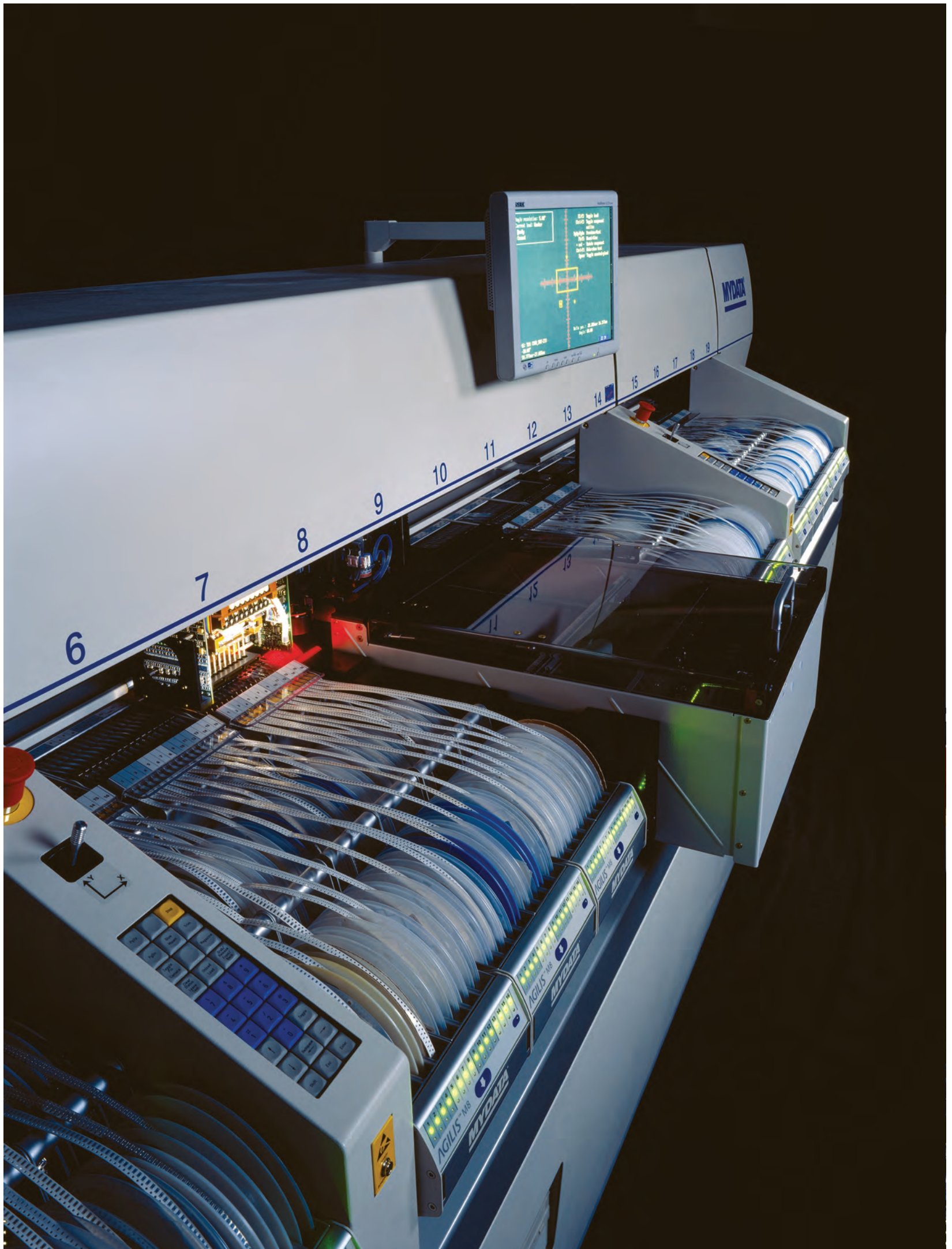

Peripheral Accessories

Barcode Reader Magazine 230V 50Hz

Description

Handheld barcode scanner for loading magazines. Recognizes the following symbologies: UPC E, A, EAN, Code 39; Interleaved, Matrix, Industrial and Standard 2 of 5; Code 128, UCC EAN 128, Codabar, Code 93, MSI, Plessey. Cable length: 1.8 m (70").

This product is for a line voltage of 230V 50Hz.

Machine type:

TP9-1 , TP9-2 , TP9-3 , TP9-4 , TP11 , TP12 , TP18 , MY9 , MY12 , MY15 , MY19

Requirements:

Barcode Software (0506), Barcode Sticker for magazines.

Part no.	Product name
L-010-0130	Barcode Reader Magazine 230V 50Hz

Barcode Reader Magazine 110/120V 60Hz

Description

Handheld barcode scanner for loading magazines. Recognizes the following symbologies: UPC E, A, EAN, Code 39; Interleaved, Matrix, Industrial and Standard 2 of 5; Code 128, UCC EAN 128, Codabar, Code 93, MSI, Plessey. Cable length: 1.8 m (70").

This product is for a line voltage of 110-120V 60Hz.

Machine type:

TP9-1 , TP9-2 , TP9-3 , TP9-4 , TP11 , TP12 , TP18 , MY9 , MY12 , MY15 , MY19

Requirements:

Barcode Software (0506), Barcode Sticker for magazines.

Part no.	Product name
L-010-0131	Barcode Reader Magazine 110/120V 60Hz

Barcode Stickers

Description

For use with MYLabel or TPSys Barcode SW. Combo stickers eliminate one scan by combining magazine ID and feeder ID into one barcode.

Requirements:

Combo stickers: MYLabel 2.0 or later, or TPSys 2.2 or later with Barcode Software (0506)

Part no.	Product name
D-014-1481	Barcode Combo Sticker TM8/8F/FLEX
D-014-1482	Barcode Combo Sticker TM12/1216/16
D-014-1483	Barcode Combo Sticker TM24
D-014-1484	Barcode Combo Sticker TM32

Part no.	Product name
D-014-1485	Barcode Combo Sticker TM44/5632
D-014-1486	Barcode Combo Sticker VMF30
D-014-1487	Barcode Prefix Sticker 1 (TPSys 2.3 or older)
D-014-1937	Barcode Prefix Sticker 2 (TPSys 2.4 or later)

Light Tower

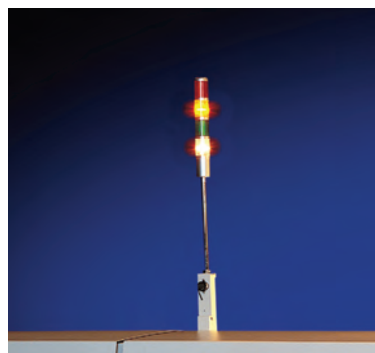

Description

An easy way to show the status of a placement machine, the tower has four different colored lights: red, yellow, green and white plus a buzzer. Seven different machine states (or events) can be signaled. The states are set through the machine software parameters.

Requirements:

TPSys 1.5 or later.

Ordering info:

Please state serial number of machine when ordering.

Part no.	Product name
L-010-0144B	Light Tower TP9-2U
L-010-0124B	Light Tower TP9-2/3
L-010-0127B	Light tower TP9-4/11
L-010-0128B	Light tower TP12/18
L-040-0011B	Light Tower MY-Series

Printer 230V with cables

Description

Printer OKI B4350 NPS - Euro. (230V). Cables included.

Machine type:

MY9 , MY12 , MY15 , MY19

Part no.	Product name
L-040-0583	Printer 230V with cables

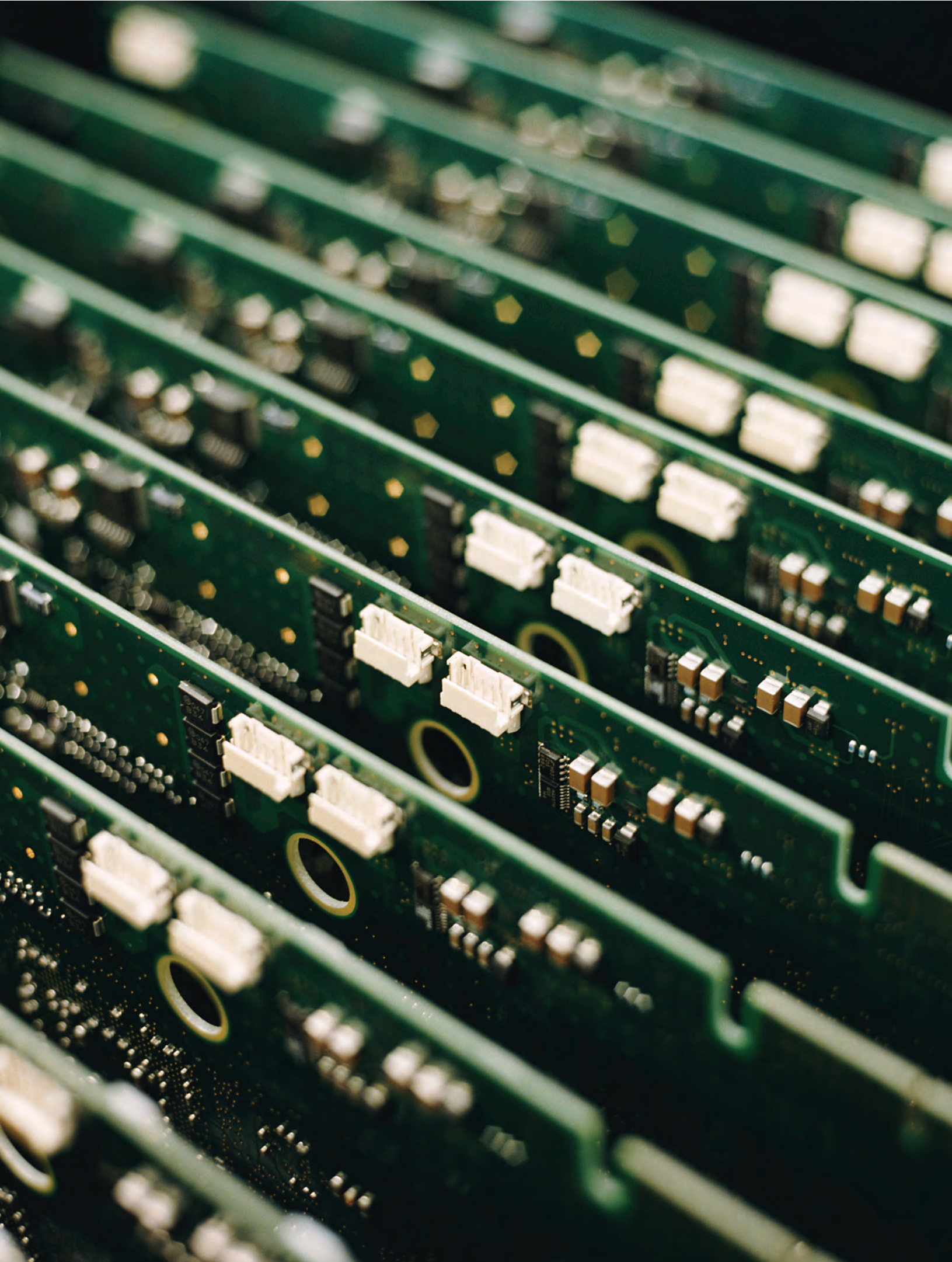

Glue System

Flexible Glue Station 2



Description

Applying adhesive to a board by pin transfer may be done prior to component placement. Single or multiple glue dot patterns are defined in the package list for each package. This product is supplied with 2 glue pots and leveling arms. Occupies one magazine position.

L-044-0001 contains everything you need to install and run a Flexible Glue Station on one machine. If you want to use the same Flexible Glue Station on other machines, you need one L-044-0005 for each additional machine.

Machine type:

MY12 , MY15 , MY19 , MY9 , TP11 , TP9-4

Requirements:

MY-series machine or TP-series machine with Hydra.

Part no.	Product name
L-044-0001	Flexible Glue Station 2

Flexible Glue Station 2 Machine Kit



Description

If you want to use a Flexible Glue Station (L-044-0001) on more than one machine, you need one L-044-0005 for each additional machine.

Machine type:

MY12 , MY15 , MY19 , MY9 , TP11 , TP9-4

Part no.	Product name
L-044-0005	Flexible Glue Station 2 Machine Kit

Upgrade kit GS2 TP9/11

Description

For upgrading a TP9 or TP11 that is not prepared for a Fixed Glue station.

Machine type:

TP11 , TP9-2 , TP9-3 , TP9-4

Part no.	Product name
L-014-0721	Upgrade kit GS2 TP9/11

Upgrade kit GS2 TP12/18

Description

For upgrading a TP12 or TP18 that is not prepared for a Fixed Glue station.

Machine type:

TP12 , TP18

Part no.	Product name
L-014-0722	Upgrade kit GS2 TP12/18

Upgrade Kit from GS1 to GS2

Description

This upgrade kit will upgrade Glue Station 1 to Glue Station 2. The upgrade kit should be ordered if an old Glue Station (not Glue Station 2) is to be used on a machine that has a MOT3-M control board (typically all MY-Series machines and machines equipped with TEX have a MOT3).

Part no.	Product name
L-014-0720	Upgrade Kit from GS1 to GS2

Tool C12



Description

Glue tool 0.5 mm (0.0197") tip. Typical component types: 0603, 0805.

Machine type:
MY12 , MY15 , MY19 , MY9 , TP11 , TP12 , TP18 , TP9-1 , TP9-2 ,
TP9-3 , TP9-4

Part no.	Product name
L-012-0023C	Tool C12

Tool B12



Description
Glue tool 0.8 mm (0.0315") tip. Typical component types: 0805,
1206.

Machine type:
MY12 , MY15 , MY19 , MY9 , TP11 , TP12 , TP18 , TP9-1 , TP9-2 ,
TP9-3 , TP9-4

Part no.	Product name
L-012-0017C	Tool B12

Tool B13



Description
Glue tool 1.5 mm (0.0590") tip. Typical component types: 1812,
MELFs.

Machine type:
MY12 , MY15 , MY19 , MY9 , TP11 , TP12 , TP18 , TP9-1 , TP9-2 ,
TP9-3 , TP9-4

Part no.	Product name
L-012-0018C	Tool B13

Tool C13



Description
Glue tool 2.2 mm (0.0866") tip. Typical component types: MELFS,
SOs.

Machine type:
MY12 , MY15 , MY19 , MY9 , TP11 , TP12 , TP18 , TP9-1 , TP9-2 ,
TP9-3 , TP9-4

Part no.	Product name
L-012-0024C	Tool C13

Tool B14



Description
Glue tool 3.2 mm (0.1260") tip. Typical component types: SO, LCCC,
PLCC.

Machine type:
MY12 , MY15 , MY19 , MY9 , TP11 , TP12 , TP18 , TP9-1 , TP9-2 ,
TP9-3 , TP9-4

Part no.	Product name
L-012-0019C	Tool B14



Miscellaneous

Shipping crates



Description

Suitable MY-Series packing for export outside EU

Part no.	Product name
K-040-0340	Crate MY9
K-040-0341	Crate MY12
K-040-0342	Crate MY15
K-040-0343	Crate MY19

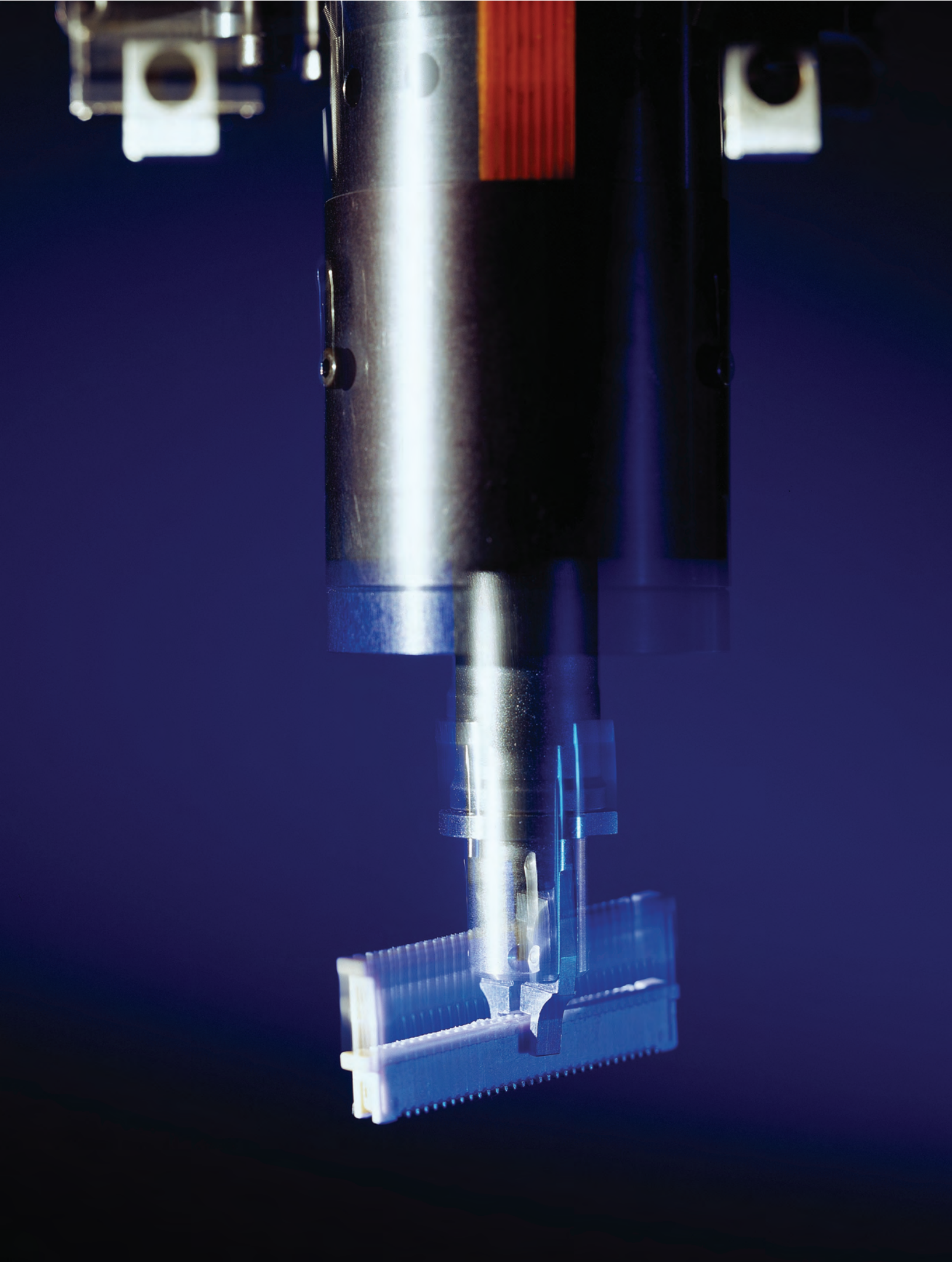

Custom Products

The requirements of production equipment are something that might change over time. At some point you might need to produce a job that has some non-standard characteristics be it an odd component or an extra large PCB. MYDATA offers custom design of new machines as well as custom designed upgrade kits for installed machines, so you can avoid the expense of reconfiguring your line or buying in new equipment.

Typical areas for customizations are mount and glue tools, feeders and board handling systems, all of which extend the specifications of the machine. This chapter shows some examples of previous customizations.

Proline ML7

Description

Specifications:

Max. PCB size: 1117.6 x 812.8 (44" x 32").

PCB thickness (3 ranges):included

0.5 - 4.0 mm (0.019" - 0.157").

3.0 - 8.0 mm (0.118" - 0.314").

8.0 - 10.0 mm (0.314" - 0.393").

Max. PCB weight: 10.0kg (22.04 lbs).

Machine type:

MY19

Part no.	Product name
L-009-0263	Proline ML7

Conveyor 500T2 with extension Kit 28", thick boards

Description

Conveyor 500T2 with active extension without clamping function, intended for rigid boards.

Specifications:

Max. PCB size: 508 x 711 mm (20" x 28").
 Min. PCB size: 70 x 50 mm (2.75" x 1.97").
 PCB thickness: 3.0 - 7.62 mm (0.118" - 0.300").
 Max. PCB weight: 4kg (8.8 lbs).

Machine type:

HYDRA , MY12 , MY15 , MY19 , MY9 , TP11

Part no.	Product name
L-009-0269	Conveyor 500T2 with extension Kit 28", thick boards

Part no.	Product name
L-009-0147	Conveyor 500T2 with extension Kit 24"

Conveyor 500T2 with extension Kit 28", thin boards

Description

Conveyor 500T2 with active extension without clamping function, intended for rigid boards.

Specifications:

Max. PCB size: 508 x 711 mm (20" x 28").
 Min. PCB size: 70 x 50 mm (2.75" x 1.97").
 PCB thickness: 1.0 - 4.0 mm (0.039" - 0.157").
 Max. PCB weight: 4kg (8.8 lbs).

Machine type:

HYDRA , MY12 , MY15 , MY19 , MY9 , TP11

Part no.	Product name
L-009-0281	Conveyor 500T2 with extension Kit 28", thin boards

Conveyor 500T2 with extension Kit 24"

Description

Conveyor 500T2 with active extension without clamping function, intended for rigid boards.

Specifications:

Max. PCB size: 508 x 610 mm (20" x 24").
 Min. PCB size: 70 x 50 mm (2.75" x 1.97").
 PCB thickness: 1.0 - 4.0 mm (0.039" - 0.157").
 Max. PCB weight: 4kg (8.8 lbs).

Machine type:

HYDRA , MY12 , MY15 , MY19 , MY9 , TP11

Tool double nozzle CC8 C24

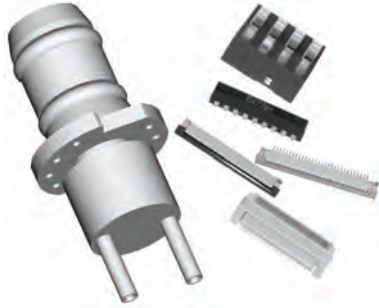

Description
Nozzle Dimensions:
d=2x2mm, cc 8mm, height 8mm.

Typical component: Connectors with leads on the side, coils or components with a center hole.

Part no.	Product name
L-009-0003	Tool double nozzle CC8 C24

Tool double nozzle CC4.3MM



Description
Nozzle Dimensions:
d=2x1.2 mm, cc 4.3mm, height 8 mm.

Typical component: Connectors with leads on the side, coils or components with a center hole.

Part no.	Product name
L-009-0457	Tool double nozzle CC4.3MM

Tool double nozzle CC 6



Description
Nozzle Dimensions:
d=2x3 mm, cc 6 mm, height 8 mm.

Typical component: Connectors with leads on the side, coils or components with a center hole.

Part no.	Product name
L-009-0151B	Tool double nozzle CC 6

Tool double nozzle CC 11 MM

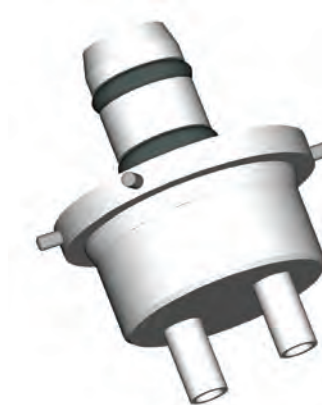

Description
Nozzle Dimensions:
d=2x4 mm, cc 11 mm, height 8 mm.

Typical component: Connectors with leads on the side, coils or components with a center hole.

Requirements:
Toolbank L-009-0287

Part no.	Product name
L-009-0360	Tool double nozzle CC 11 MM

Tool double nozzle CC4.1 OD1.5

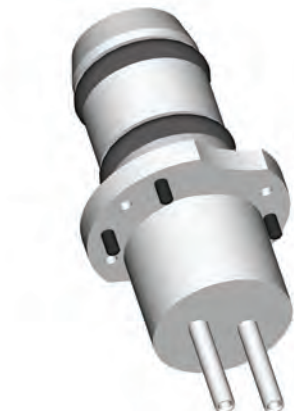

Description

Nozzle Dimensions:
d=2x1.5 mm, cc 4,1mm, height 8 mm.

Typical component: Connectors with leads on the side, coils or components with a center hole.

Part no.	Product name
----------	--------------

L-009-0350	Tool double nozzle CC4.1 OD1.5
------------	--------------------------------

Tool double nozzle CC 15

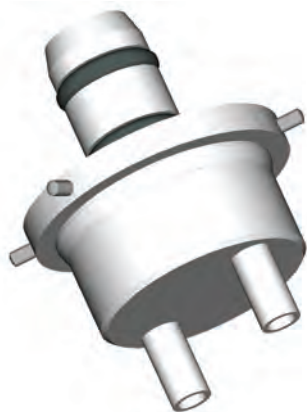

Description

Nozzle Dimensions:
d=2x4.0mm, cc 15.0mm, height 8 mm.

Typical component: Connectors with leads on the side, coils or components with a center hole.

Requirements:
Toolbank L-009-0287

Part no.	Product name
----------	--------------

L-009-0346	Tool double nozzle CC 15
------------	--------------------------

Tool double nozzle CC3.8 45D



Description

Nozzle Dimensions
d=2x 1.5 mm, cc 3.8 mm, height 8 mm.

Typical component: Connector, coils or components with a center hole.

Part no.	Product name
----------	--------------

L-009-0019	Tool double nozzle CC3.8 45D
------------	------------------------------

Tool double nozzle MELF CC 4,8



Description

Nozzle Outer Dimensions
Radius 3.6 mm, d=3 mm, cc=4.8 mm.

Component Size:
OD 7.2mm
Length 8mm

Typical component: special MELFs.

Placement Tools

Part no.	Product name
L-009-0090	Tool double nozzle MELF CC 4,8

Tool double nozzle CC 4.1



Description
Nozzle outer dimensions CC 4.1mm, R=2.3mm, D=3.0mm

Part no.	Product name
L-009-0370	Tool double nozzle CC 4.1

Tool spring picking C24



Description
Do=1.5mm, dt=0.15mm
Typical component: For cylindrical type components, such as springs and coils.

Part no.	Product name
L-009-0018	Tool spring picking C24

Thin nozzle tool



Description
d=0.5 mm,
Typical components: Mounting of small components in narrow areas or close to tall components, e.g. MCM.

Part no.	Product name
L-009-0063	Thin nozzle tool

Multi dot glue tool



Description
Pin d=1.5 mm, pattern cc 3.85x3.25
Typical component: Sets a rectangular pattern of glue dots on the circuit board.

Part no.	Product name
L-009-0036	Multi dot glue tool

Magnet tool



Description
 Picks the component with magnetism instead of vacuum, D=11.2 mm.
 Typical components: Coils or other magnetic components.

Part no.	Product name
L-012-0379	Magnet tool

Double flat pipe nozzle



Description
 Nozzle Outer Dimensions
 Two flat tubes, 4.1 x 1 mm, cc = 4.2 mm, nozzle height = 9.5 mm.

Component Size:
 Width 7-11mm
 Height 3-6mm
 Length 5-22mm
 Switches centred on top of component

Typical components: DIP switches.

Part no.	Product name
L-009-0296	Double flat pipe nozzle

Flat pipe nozzle micro



Description
 Nozzle outer dimension 1.5mm x 1.0mm

Part no.	Product name
L-009-0357	Flat pipe nozzle micro

Double flat pipe nozzle

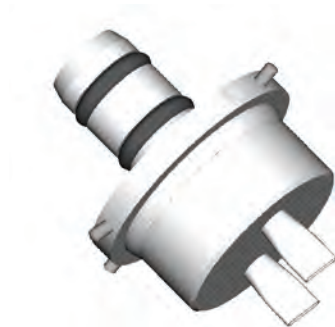

Description
 CC 10mm, nozzle height 8.0mm

Requirements:
 Tool bank L-009-0287

Placement Tools

Part no.	Product name
L-009-0393	Double flat pipe nozzle

Gripper tool



Description
 Grip 0-4.5 mm. jaws; width 4mm, height 4 mm.
 Typical components: Connectors, and odd shape components.

Part no.	Product name
L-012-0115	Gripper tool

Gripper tool



Description
 Grip 5.4-7.8 mm jaws; width 4 mm, height 1.5 mm.
 Typical components: Dip switch, connectors.

Part no.	Product name
L-009-0051	Gripper tool

Gripper tool



Description
 Grip 3.6-6.4 mm jaws; width 5 mm, height 3.2 mm.
 Typical components: Connectors, odd shape components.

Part no.	Product name
L-009-0163	Gripper tool

Gripper tool



Description
 Grip 2-6 mm jaws; width 5 mm, height 5 mm.
 Typical components: Connectors, odd shape components.

Part no.	Product name
L-009-0089	Gripper tool

Gripper tool



Description
 Grip 2-5 mm jaws; width 5 mm, height 2 mm.
 Typical components: Connectors, odd shape components.

Part no.	Product name
L-009-0111	Gripper tool

Gripper tool



Description
 Grip 3.9-6.84mm jaws; width 8 mm, height 3.1mm.
 Typical components: Connectors, odd shape components.

Part no.	Product name
L-009-0449	Gripper tool

Gripper tool, moonstyle



Description
 Grip, min opening 14.4mm

Requirements:
 Toolbank L-009-0287, For ML table needs spacer D-009-0077

Part no.	Product name
L-009-0452	Gripper tool, moonstyle

Gripper tool



Description
 Grip 3.0-6.5mm jaws; width 6.0 mm, height 3.0mm.
 Typical components: Connectors, odd shape components.

Part no.	Product name
L-009-0445	Gripper tool

Gripper tool



Description
 Grip 13.3- 19.76 mm jaws; width 2 mm, height 3 mm.
 Typical components: long and narrow part with glue/solderpast on the surface.

Requirements:
 Toolbank L-009-0287

Part no.	Product name
L-009-0419	Gripper tool

Gripper tool



Description
 Grip 9.0- 14.66 mm jaws; width 2 mm, height 3 mm.
 Typical components: long and narrow part with glue/solderpast on the surface.

Requirements:
 Tool bank L-009-0287

Part no.	Product name
L-009-0420	Gripper tool

Gripper tool round jaws



Description
 Grip, round jaws IR 3.2mm
 typical components: round with D 6-9mm

Part no.	Product name
L-009-0418	Gripper tool round jaws

Gripper tool

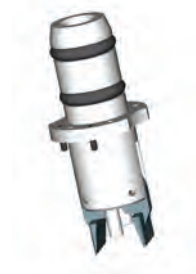

Description
 Grip 3.5-7.8mm jaws; width 8 mm, height 2.5mm.
 Typical components: Connectors, odd shape components.

Part no.	Product name
L-009-0417	Gripper tool

Gripper tool with thin jaws



Description
 Grip 5.0-6.5mm jaws; width 8 mm, height 4.0
 Typical components: Connectors in narrow tape cavity

Part no.	Product name
L-009-0416	Gripper tool with thin jaws

Gripper tool with thin jaws



Description
 Grip 3.0-4.4mm jaws; width 4 mm, height 3.4
 Typical components: Connectors in narrow tape cavity

Part no.	Product name
L-009-0412	Gripper tool with thin jaws

Gripper tool

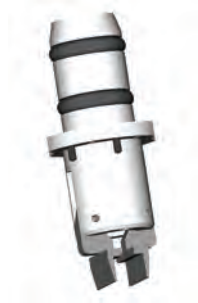

Description
 Grip 3.0-4.4mm jaws; width 8 mm, height 3.5mm.
 Typical components: Connectors, odd shape components.

Part no.	Product name
L-009-0400	Gripper tool

Gripper tool



Description
 Grip round components OD 6.0mm, height 5.0mm

Part no.	Product name
L-009-0297	Gripper tool

Gripper tool



Description
 Grip 6.0-11.0mm jaws; width 4.0 mm, height 5.0mm.
 Typical components: Connectors, odd shape components.

Part no.	Product name
L-012-0117	Gripper tool

Placement Tools

Low force tool



Description

A13 tip, placement force 0.25N.

Component Size:

Same as for standard tool A13

Typical component: Fragile components or for mounting on fragile substrates.

Part no.	Product name
----------	--------------

L-009-0071	Low force tool
------------	----------------

MELF tool, Micro



Description

Tooltip Radius 0.5 mm, d=2 mm, insulated.

Component Size:

OD 1mm

Typical component: Micro MELFs.

Part no.	Product name
----------	--------------

L-009-0230B	MELF tool, Micro
-------------	------------------

Ring tool



Description

For metallic rings OD 1.82mm ID 0.69mm

Part no.	Product name
----------	--------------

L-009-0459	Ring tool
------------	-----------

Ring tool



Description

For metallic rings OD 2.54mm ID 2.11mm

Part no.	Product name
----------	--------------

L-009-0458	Ring tool
------------	-----------

Tube tool

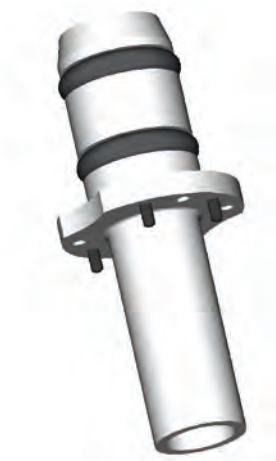

Description
 OD 8mm ID 6.1mm
 Typical components : Large led

Part no.	Product name
L-009-0436	Tube tool

Kernel pipe tool



Description
 OD 5.4mm ID 3.0mm

Part no.	Product name
L-009-0345	Kernel pipe tool

HYDRA tool for Midas



Description
 The square-shaped end of the tool is named 12U3
 tooltip can be order from www.micro-mechanics.com

Part no.	Product name
L-012-0574	HYDRA tool for Midas

Triple suction cup tool

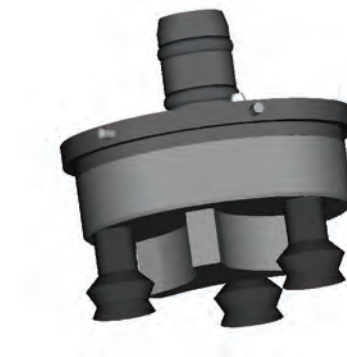

Description
 D= 40mm
 Typical components: Large and heavy QFP type

Requirements:
 Tool bank L-009-442

Part no.	Product name
L-009-0441	Triple suction cup tool

Placement Tools

Tool QFP 19mm



Description

D= 19mm

Typical components: Large QFP

Requirements:

Toolbank L-009-0287, For ML table needs spacer D-009-0077

Part no.	Product name
----------	--------------

L-009-0284	Tool QFP 19mm
------------	---------------

Bellow suction cup tool



Description

OD 15mm

Requirements:

Toolbank L-009-0287

Part no.	Product name
----------	--------------

L-009-0408	Bellow suction cup tool
------------	-------------------------

Tool QFP 22mm



Description

D= 22mm

Typical components: Large QFP

Requirements:

Toolbank L-009-0287, For ML table needs spacer D-009-0077

Part no.	Product name
----------	--------------

L-009-0255	Tool QFP 22mm
------------	---------------

Double suction cup tool



Description

CC 21mm

Typical component: no suction area between CC distans

Requirements:

Tool bank L-009-0439

Part no.	Product name
----------	--------------

L-009-0434	Double suction cup tool
------------	-------------------------

Bellow suction cup tool



Description
OD 10.0mm

Part no.	Product name
L-009-0308	Bellow suction cup tool

Double suction cup tool



Description
CC 11.0mm

Requirements:
Toolbank L-009-0287

Part no.	Product name
L-009-0301B	Double suction cup tool

Tool bank for very large tool

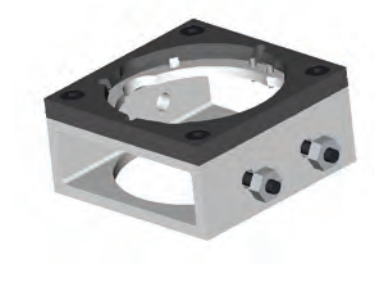

Description
Tool bank for very large tool

Part no.	Product name
L-009-0442	Tool bank for very large tool

Tool bank

Description
Toolbank for L-009-0434

Part no.	Product name
L-009-0439B	Tool bank

Tool bank

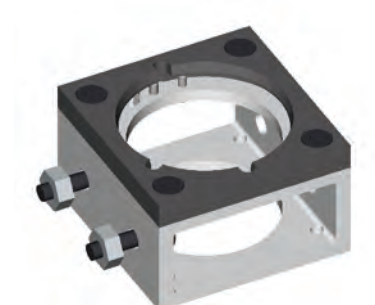

Description
Toolbank for L-009-0434

Part no.	Product name
L-009-0439	Tool bank

Tool bank



Description
Toolbank for L-009-0284, L-009-0255, L-009-0452, L-009-0408,
L-009-0419, L-009-0420, L-009-0393, L-009-0360, L-009-0346,
L-009-0301B

Part no.	Product name
L-009-0287	Tool bank

Part Number Index

Part no.	Product name	Page	Part no.	Product name	Page
00030	400PT Inline Conveyor	7	03604	AT-CPU2 PF1 with CP5	17
00031	400PT Hood Kit	25	03604	AT-CPU2 PF1 with CP5	17
00031	400PT Hood Kit	25	03604	AT-CPU2 PF1 with CP5	17
0004	500T2 Inline Conveyor	7	03640	AT-CPU1 PF2 with CP54	96
00041	500T2 Hood Kit	25	03641	AT-CPU2 PF2 with CP54	96
00041	500T2 Hood Kit	25	03642	AT-CPU2 PF2 with CP5	96
0005	ML3 Manual Load	7	03642	AT-CPU2 PF2 with CP5	96
0006	ML4 Manual Load	7	03642	AT-CPU2 PF2 with CP5	96
0007	ML5 Manual Load	8	03642	AT-CPU2 PF2 with CP5	96
0008	ML6 Manual Load	8	03670	2 Monitors	96
00103	T3 Inline Conveyor	6	03671	3 Monitors	96
00104	T4 Inline Conveyor	6	04010	HYDRA 21k MY9	9
00105	T5 Inline Conveyor	6	04011	HYDRA 14k MY9	8
00106	T6 Inline Conveyor	6	04011	HYDRA 14k MY12	8
0201	Y 345/200V 3 phase EU	12	04011	HYDRA 14k MY15	8
0202	Y 365/210V 3 phase EU	12	04011	HYDRA 14k MY19	8
0203	Y 370/215V 3 phase EU	12	04012	HYDRA 21k MY9, ER LVS	9
0204	Y 380/220V 3 phase EU	12	04014	HYDRA 21k MY9	15
0205	Y 390/225V 3 phase EU	12	04016	HYDRA 21k MY9, ER T-LVS	10
0206	Y 400/230V 3 phase EU	12	04017	HYDRA 21k ER For LVS MY9	15
0207	Y 410/235V 3 phase EU	12	04020	HYDRA 21k MY12	9
0208	Y 415/240V 3 phase EU	12	04022	HYDRA 21k MY12, ER LVS	9
0209	Y 435/250V 3 phase EU	12	04024	HYDRA 21k MY12	15
0210	D 190/110V 3 phase EU	12	04026	HYDRA 21k MY12, ER T-LVS	10
0211	D 200/115V 3 phase EU	12	04027	HYDRA 21k ER For LVS MY12	15
0212	D 210/121V 3 phase EU	12	04030	HYDRA 21k MY15	9
0213	D 215/125V 3 phase EU	12	04032	HYDRA 21k MY15, ER LVS	9
0214	D 220/127V 3 phase EU	12	04034	HYDRA 21k MY15	15
0215	D 225/130V 3 phase EU	12	04036	HYDRA 21k MY15, ER T-LVS	10
0216	D 230/133V 3 phase EU	12	04037	HYDRA 21k ER For LVS MY15	15
0217	D 235/136V 3 phase EU	12	04040	HYDRA 21k MY19	9
0218	D 240/140V 3 phase EU	12	04042	HYDRA 21k MY19, ER LVS	9
0219	D 250/145V 3 phase EU	12	04044	HYDRA 21k MY19	15
0220	D 200V 3 phase JPN	12	04046	HYDRA 21k MY19, ER T-LVS	10
0230	D 190/100V 3 phase US	12	04047	HYDRA 21k ER For LVS MY19	15
0232	D 210/121V 3 phase US	12	04053	TVS Slot Kit	15
0238	D 240/140V 3 phase US	12	04110	Single Linescan Vision System	10
0239	D 250/145V 3 phase US	13	04111	Twin Linescan Vision System	10
0301	English US STD	12	04500	Flexible Glue Station 2 for MY-Series	12
0302	French US STD	12	0491	Light Tower	12
0303	Spanish US STD	12	0501	2PT1 RCD Verifier	27
0304	Portug. US STD	12	0501	2PT1 RCD Verifier	27
0305	English EU STD	12	0501	2PT1 RCD Verifier	27
0306	French EU STD	12	0502	3PT1 RCDT Verifier	27
0307	Spanish EU STD	12	0502	3PT1 RCDT Verifier	27
0308	German EU STD	12	0502	3PT1 RCDT Verifier	27
0309	Swedish EU STD	12	0503	Shared Databases	28
0310	Finnish EU STD	12	0503	Shared Databases	28
0311	Italian EU STD	12	0503	Shared Databases	28
0312	Dutch EU STD	12	0505	Upgrade from 2PT1 to 3PT1	27
0313	Portug. EU STD	12	0505	Upgrade from 2PT1 to 3PT1	27
0314	Norweg. EU STD	12	0506	Barcode Software	28
0315	Danish EU STD	12	0506	Barcode Software	28
0316	Japanese US STD	12	0506	Barcode Software	28
03230	Upgrade step from SYS 2.9 (9268 & above)	96	0512	Logging EI. Measurement Software	27
03231	Upgrade step from TPSys 1.3/1.4	96	0512	Logging EI. Measurement Software	27
03232	Upgrade step from TPSys 1.6/1.5	96	0512	Logging EI. Measurement Software	27
03233	Upgrade step from TPSys 2.0	96	0514	Pre-pick inspection	29
03234	Upgrade step from TPSys 2.1	96	0514	Pre-pick inspection	29
03235	Upgrade step from TPSys 2.2	96	0514	Pre-pick inspection	29
03236	Upgrade step from TPSys 2.3	96	D-014-1155	Rotatable Shaft Deep Flex	75
03237	Upgrade step from TPSys 2.4	96	D-014-1481	Barcode Combo Sticker TM8/8F/FLEX	106
0324	Upgrade step from TPSys 1.3/1.4	96	D-014-1482	Barcode Combo Sticker TM12/1216/16	106
0325	Upgrade step from TPSys 1.5/1.6	96	D-014-1483	Barcode Combo Sticker TM24	106

Part Number Index

Part no.	Product name	Page	Part no.	Product name	Page
D-014-1484	Barcode Combo Sticker TM32	106	K-017-0446	Transport Conveyor Light 1000	50
D-014-1485	Barcode Combo Sticker TM44/5632	106	K-017-0447	Transport Conveyor Light 1500	50
D-014-1486	Barcode Combo Sticker VMF30	106	K-017-0448	Transport Conveyor Light 2000	50
D-014-1487	Barcode Prefix Sticker 1 (TPSys 2.3 or older)	106	K-017-0449	Transport Conveyor Light 2500	50
D-014-1728	Holder cover TM12	70	K-017-0450	Manual Loader Light	46
D-014-1923	Holder cover for Flex feeder 32	76	K-017-0451	Manual Unloader Light	46
D-014-1924	Holder cover for Flex feeder 44	76	K-017-0452	Transport Conveyor Package Light for MY9	41
D-014-1925	Holder cover for Flex feeder 56	76	K-017-0453	Transport Conveyor Package Light for MY12/15	41
D-014-1926	Holder cover for Flex feeder 72	76	K-017-0454	Transport Conveyor Package Light for MY19	42
D-014-1937	Barcode Prefix Sticker 2 (TPSys 2.4 or later)	106	K-017-0455	End of Line Conveyor Option	52
K-017-0003	PCB Magazine 297	56	K-017-0456	Start of Line Conveyor Option	52
K-017-0004	PCB Magazine 397	56	K-017-0457	Manual Reloader Light	47
K-017-0124	Motorised Width Adjustment Option	52	K-017-0472	Light Tower Option	53
K-017-0127	Adjustable Conveyor Speed Option	52	K-017-0474	SMEMA Machine Ready Detection Option	53
K-017-0128	Workstation Framework 1500	57	K-017-0475	SMEMA Board Available Detection Option	53
K-017-0129	Workstation Framework 1000	57	K-017-0476	Conveyor Floor Braces	53
K-017-0130	C-Profiled Stand 1500	54	K-017-0477	Reloader Conveyor Light 500	50
K-017-0131	C-Profiled Stand 1000	54	K-017-0478	Reloader Conveyor Light 1000	50
K-017-0132	Overhead Lighting 1000	57	K-017-0481	Upgrade Kit Board Train T5/T6	55
K-017-0133	Overhead Lighting 500	57	K-017-0484	Board Train Function T5/T6	55
K-017-0134	Suspension Rail 1500	58	K-017-0486	PCB Magazine 310	56
K-017-0135	Suspension Rail 1000	58	K-017-0487	Auto Width Inline Option	53
K-017-0136	Plastic ESD Storage Box	54	K-017-0488	Auto Width Control Unit Option	53
K-017-0137	Extensible Shelf 1500	58	K-017-0489	In-line Barcode Reader Light Conv	56
K-017-0138	Extensible Shelf 1000	58	K-017-0490	In-line Barcode Reader T5/T6 Conv	56
K-017-0139	Adjustable Shelf 1500	58	K-017-0491	TRP/BU Conv Package T5/T6 MY15	41
K-017-0140	Adjustable Shelf 1000	58	K-017-0492	TRP/BU Conv Package T5/T6 MY19	42
K-017-0141	Power Rail 220 100/1500	54	K-017-0493	TRP/BU Conv Package T5/T6 MY12/MY15	42
K-017-0142	Foot Rest	54	K-017-0494	Workstation 1000 Acc Package 1	57
K-017-0184	Turn Unit	49	K-017-0495	Workstation 1000 Acc Package 2	57
K-017-0185	Telescopic Gate 1650	49	K-017-0496	Workstation 1500 Acc Package 1	57
K-017-0186	Manual Gate Conveyor	48	K-017-0497	Workstation 1500 Acc Package 2	57
K-017-0187	Board Transfer System	47	K-017-0498	Workstation Release Pedal	55
K-017-0188	FIFO/LIFO Buffer Unit	48	K-017-0499	Conveyor Slide Extention Option	55
K-017-0189	Board Inverter	47	K-017-0500	Adjustable Sensor Arm Upgrade	55
K-017-0190	Overhead Conveyor 1000	49	K-017-0516	T3 Conveyor 500	42
K-017-0191	Barcode Reader for Conveyor Option	56	K-017-0517	T3/T4 Conveyor 700	42
K-017-0198	Overhead Lighting 1000, 110V	57	K-017-0518	T3 Conveyor 1000	42
K-017-0200	Transport-Buffer Narrow 400PT 1000	49	K-017-0519	T3 Conveyor 1500	43
K-017-0270	Transport-Buffer Narrow 400PT 1500	50	K-017-0520	T3 Conveyor 2000	43
K-017-0271	Transport-Buffer Conveyor T5/T6 1000	50	K-017-0521	T3 Conveyor 2500	43
K-017-0272	Transport-Buffer Conveyor T5/T6 1500	50	K-017-0522	T4 Conveyor 1000	43
K-017-0273	Transport-Buffer Conveyor T5/T6 2000	50	K-017-0523	T4 conveyor 1500	43
K-017-0274	Transport-Buffer Conveyor T5/T6 2500	50	K-017-0524	T4 conveyor 2000	43
K-017-0284	Overhead Lighting 500 110V	57	K-017-0525	T4 Conveyor 2500	43
K-017-0285	Inspection Option	52	K-017-0526	T3 Conveyor Package MY9	40
K-017-0286	Magazine Trolley	69	K-017-0527	T3 Conveyor Package MY12/MY15	40
K-017-0287	Tool Tray Magazine Trolley	69	K-017-0528	T3 Conveyor Package MY19	40
K-017-0289	Tool Tray ESD Insert	70	K-017-0529	T4 Conveyor Package MY12/MY15	40
K-017-0290	Document Holder Magazine Trolley	70	K-017-0530	T4 Conveyor Package MY19	40
K-017-0292	ESD Insert for Trolley Shelf	70	K-017-0531	Board Train Function T3/T4	55
K-017-0294	PCB Magazine 390	56	K-017-0532	Safety Cover + Safety Loop T3/T4	52
K-017-0295	PCB Magazine 460	56	K-017-0533	Workstation 1000 T3	51
K-017-0296	PCB Magazine 510	56	K-017-0534	Workstation 1000 T4	51
K-017-0445	Transport Conveyor Light 500	50	K-017-0535	Workstation 1500 T3	51
			K-017-0536	Workstation 1500 T4	51
			K-017-0537	In-line Barcode Reader T3/T4 Conv	56
			K-017-0555	T3 MYSynergy Package MY9/MY19	41
			K-017-0556	T3 MYSynergy Package MY9/MY12	41

Part Number Index

Part no.	Product name	Page	Part no.	Product name	Page
K-017-0557	T3 MYSynergy Package MY12/MY12	41	K-040-0068	MYCam 6th License	101
K-017-0561	Automatic Loader	45	K-040-0069	All CAD Import Formats	101
K-017-0562	Automatic Unloader	45	K-040-0070	CAD THEDA BY INCASES	101
K-017-0563	Automatic Reloader	45	K-040-0071	CAD ULTIBOARD	101
K-017-0590	Single Loader	44	K-040-0072	Camalot Full Line Disp Interface	102
K-017-0591	Single Unloader	44	K-040-0073	Europlacer Interface	102
K-017-0596	Auto Detection of PCBs in Magazine	56	K-040-0074	Siemens Siplace Interface	102
K-017-0597	Auto Detect and Communication Loader to Unloader	57	K-040-0075	Siemens HS Series Interface	102
K-017-0598	Additional Magazine Conveyor Unit	54	K-040-0076	GenCAD Export Output Fujicam	102
K-040-0005	MYCam, All Import Interfaces	100	K-040-0081	Amistar Axial Inserter	102
K-040-0009	MYCam Documentation	100	K-040-0082	Amistar DIP Inserter	102
K-040-0010	MYCam Viewer	100	K-040-0083	Asymtek Dispensing Interface	102
K-040-0011	MYCam Reporting System	101	K-040-0085	Christopher AOI Interface	102
K-040-0013	CAD Subcon's Pckg (Gerber + ASCII Import)	101	K-040-0086	CR Technologies AOI Interface	102
K-040-0016	CAD C-Link DIF	101	K-040-0087	Dynapert Axial Inserter	102
K-040-0018	CAD GenCAD v1.4	101	K-040-0088	Dynapert DIP Inserter	102
K-040-0020	CAD PADS PowerPCB, Perform, 2000, Work	101	K-040-0090	GenCAD Export Module	102
K-040-0021	CAD Mentor Graphics	101	K-040-0091	Intelligent Reas Sys AOI Interface	102
K-040-0022	CAD Zuken Visula and Cadstar	101	K-040-0092	KME Chipshooter Interface	102
K-040-0023	CAD PCAD Import	101	K-040-0093	Machine Vision Prod AOI Interface	102
K-040-0024	CAD Accel PCAD, Tango, EDA Imp	101	K-040-0094	Orbotech AOI Interface	102
K-040-0025	CAD Tango for DOS	101	K-040-0095	Samsung Interface	102
K-040-0026	CAD Protel Import	101	K-040-0098	CAD EE Designer 3 Import	101
K-040-0027	CAD Cadence Allegro	101	K-040-0107	CAD Technomatix-Unicam WF Imp	101
K-040-0028	CAD OrCAD Import	101	K-040-0108	Upgrade from one CAD to all CAD imports	101
K-040-0029	CAD Intergraph Veribest GenCAD	101	K-040-0109	CAD Valor ODB++ Import	101
K-040-0031	CAD Intergraph Pantheon Design	101	K-040-0110	CAD Incases Import	101
K-040-0032	All Machine Import Formats	101	K-040-0111	CAD SCI Cards Import	101
K-040-0033	Amistar Coordinate Download	102	K-040-0112	CAD Contact Systems CS3 Import	101
K-040-0034	ASCII Custom Output Interface	102	K-040-0113	CAD Europlacer Import	101
K-040-0035	Celmacs Interface	102	K-040-0114	CAD Philips FTIP-1 Import	101
K-040-0036	Citizen Interface	102	K-040-0115	CAD Fuji Source Program Import	101
K-040-0037	Contact Systems 3S/3AV Interface	102	K-040-0116	CAD Panasonic POS Import	101
K-040-0038	Contact Systems CS-400 Interface	102	K-040-0117	CAD Siemens Program Import	101
K-040-0039	Dynapert I-2200 Interface	102	K-040-0118	CAD Sanyo/Universal Chipsh Im	101
K-040-0040	ECM 96 Interface	102	K-040-0120	Panasonic Panasert Interface	102
K-040-0042	Intelliplace Interface	102	K-040-0121	Speedline/MPM/Quad AVX/SMTech	102
K-040-0043	MPI/Manix Interface	102	K-040-0129	CAD Fabmaster Import	101
K-040-0044	Multitronics Interface	102	K-040-0143	CAD Panapro PCB Import	101
K-040-0045	Philips Ind. Aut. Via FTIP-2	102	K-040-0144	CAD Supermax	101
K-040-0046	Quad Systems Interface	102	K-040-0145	Ekra screen printer interface	102
K-040-0047	Sanyo TCM Chipshooter Interface	102	K-040-0146	Fuji F4G	102
K-040-0048	MPM400-500/SMTech Printers	102	K-040-0147	Fuji Source Program Interface	102
K-040-0049	Test Fixture Coordinate Output	102	K-040-0148	GPD Adhesive Dispensing Interface	102
K-040-0050	Universal Instr Axial VCD INS	102	K-040-0149	Juki HLC/2000 Series Interface	102
K-040-0051	Universal Instr Chipshooter	102	K-040-0150	Omron AOI Machine Interface	102
K-040-0052	Universal GSM Interface	102	K-040-0151	Royonix Machine Interface	102
K-040-0053	Universal Instr Multimod (DIP)	102	K-040-0153	KME PS245 Interface	102
K-040-0054	Universal Instr Radial Ins	102	K-040-0154	MIMOT SMT Interface	102
K-040-0055	Zevatech/Juki 500 Interface	102	K-040-0155	Siemens SIPLACE PRO Interface	102
K-040-0056	Zevatech/Juki 700 Interface	102	K-040-0156	Universal Advanced Axial Inserter Interface	102
K-040-0057	Contact Systems 3Z Series Interface	102	K-040-0157	Universal Advanced Multimod DIP Interface	102
K-040-0059	Quad AVX Printer Prog Interface	102	K-040-0158	XYFLEX PRO Adhesive Dispenser Interface	102
K-040-0060	Sanyo TIM Flexible Plac. Interface	102	K-040-0176	Autosplice Programming Interface	102
K-040-0061	TDK Interface	102	K-040-0177	Fuji Flexa Interface	102
K-040-0062	VI Technology AOI Machine Interface	102	K-040-0184	Takaya Flying Probe/Fixture List Interface	102
K-040-0063	MYCam Viewer Site License	101	K-040-0185	UMG Odd Form Placement Interface	102
K-040-0064	MYCam 2nd License	101	K-040-0217	Network License Manager	101
K-040-0065	MYCam 3rd License	101	K-040-0221	Accuflex Screen Printer Interface	102
K-040-0066	MYCam 4th License	101	K-040-0222	Assembleon FCM/ACM Interface	102
K-040-0067	MYCam 5th License	101			

Part Number Index

Part no.	Product name	Page	Part no.	Product name	Page
K-040-0223	Assembleon GEM LINE Interface	102	L-009-0345	Kernel pipe tool	131
K-040-0224	Yestech AOI Interface	102	L-009-0346	Tool double nozzle CC 15	123
K-040-0225	Heller Oven Interface	102	L-009-0350	Tool double nozzle CC4.1 OD1.5	123
K-040-0226	MYDATA Machine Interface	102	L-009-0357	Flat pipe nozzle micro	125
K-040-0301	MYCAM + ACCELEDA TANGO PCAD	100	L-009-0360	Tool double nozzle CC 11 MM	122
K-040-0302	MYCAM + TANGO FOR DOS IMPORT	100	L-009-0370	Tool double nozzle CC 4.1	124
K-040-0304	MYCAM + CADENCE ALLEGRO IMPORT	100	L-009-0393	Double flat pipe nozzle	126
K-040-0306	MYCAM + C-LINK DIF IMPORT	100	L-009-0400	Gripper tool	129
K-040-0307	MYCAM + EE DESIGNER 3 IMPORT	100	L-009-0408	Bellow suction cup tool	132
K-040-0308	MYCAM + FABMASTER CAD IMPORT	100	L-009-0412	Gripper tool with thin jaws	129
K-040-0309	MYCAM + GENCAD V. 1.4 IMPORT	100	L-009-0416	Gripper tool with thin jaws	129
K-040-0311	MYCAM + INCASES CAD IMPORT	100	L-009-0417	Gripper tool	128
K-040-0312	MYCAM + INTERGRAPH PANTHEON	100	L-009-0418	Gripper tool round jaws	128
K-040-0313	MYCAM + INTERGRAPH VERIBEST	100	L-009-0419	Gripper tool	128
K-040-0315	MYCAM + MENTOR GRAPHICS IMPORT	100	L-009-0420	Gripper tool	128
K-040-0317	MYCAM + ORCAD IMPORT	100	L-009-0434	Double suction cup tool	132
K-040-0318	MYCAM + PADS POWERPCB ETC	100	L-009-0436	Tube tool	131
K-040-0319	MYCAM + PANAPRO PCB IMPORT	100	L-009-0439	Tool bank	133
K-040-0320	MYCAM + PCAD PDIF IMPORT	100	L-009-0439B	Tool bank	133
K-040-0321	MYCAM + PROTEL CAD IMPORT	100	L-009-0441	Triple suction cup tool	131
K-040-0323	MYCAM + SCI CARDS IMPORT	100	L-009-0442	Tool bank for very large tool	133
K-040-0324	MYCAM + SUBCONTRACTORS PACKAGE	100	L-009-0445	Gripper tool	127
K-040-0325	MYCAM + SUPERMAX CAD IMPORT	100	L-009-0449	Gripper tool	127
K-040-0326	MYCAM + TECNOMATIX-UNICAM PDW IMPORT	100	L-009-0452	Gripper tool, moonstyle	127
K-040-0327	MYCAM + THEDA INCASES IMPORT	100	L-009-0457	Tool double nozzle CC4.3MM	122
K-040-0328	MYCAM + ULTIBOARD CAD IMPORT	100	L-009-0458	Ring tool	130
K-040-0329	MYCAM + VALOR ODB++ IMPORT	100	L-009-0459	Ring tool	130
K-040-0330	MYCAM + ZUKEN VISULA + CADSTAR	100	L-010-0117	Color Monitor Upgrade TP9-1/2/3	29
K-040-0338	MYCAM + MACHINE IMPORT SUITE	100	L-010-0124B	Light Tower TP9-2/3	106
K-040-0340	Crate MY9	114	L-010-0127B	Light tower TP9-4/11	106
K-040-0341	Crate MY12	114	L-010-0128B	Light tower TP12/18	106
K-040-0342	Crate MY15	114	L-010-0130	Barcode Reader Magazine 230V 50Hz	106
K-040-0343	Crate MY19	114	L-010-0131	Barcode Reader Magazine 110/120V 60Hz	106
L-009-0003	Tool double nozzle CC8 C24	122	L-010-0144B	Light Tower TP9-2U	106
L-009-0018	Tool spring picking C24	124	L-010-0211C	SVS For TP9-2U Installation Kit	26
L-009-0019	Tool double nozzle CC3.8 45D	123	L-010-0259	TPSys SW Options Upgrade	27
L-009-0036	Multi dot glue tool	124	L-010-0259	TPSys SW Options Upgrade	27
L-009-0051	Gripper tool	126	L-010-0270	PC Server TPSys 2.x With UPS	96
L-009-0063	Thin nozzle tool	124	L-010-0310C	SVS For TP9-3/4/TP11 Installation Kit	26
L-009-0071	Low force tool	130	L-010-0377	Barcode Scanner Cordless	97
L-009-0089	Gripper tool	126	L-010-0380	Barcode Scanner RS232	98
L-009-0090	Tool double nozzle MELF CC 4,8	124	L-010-0383	Label Printer for MYLabel	98
L-009-0111	Gripper tool	127	L-010-0386	Labels 53x55mm - Case of 18 rolls	98
L-009-0147	Conveyor 500T2 with extension Kit 24"	120	L-010-0395	MYLabel 4 Kit w Cordless Scanners	97
L-009-0151B	Tool double nozzle CC 6	122	L-010-0397	MYLabel 4 Upgrade from 2.X	98
L-009-0163	Gripper tool	126	L-010-0398	MYLabel 4 Upgrade from 3.X	99
L-009-0230B	MELF tool, Micro	130	L-010-0403	MOT3-Z Upgrade for Hydra 2D on MY19	16
L-009-0255	Tool QFP 22mm	132	L-010-0457	Midas Upgrade Kit	19
L-009-0263	Proline ML7	118	L-010-0470	MYLabel 4 Software	97
L-009-0269	Conveyor 500T2 with extension Kit 28", thick boards	120	L-010-0521	MYPlan Single Job Optimization	99
L-009-0281	Conveyor 500T2 with extension Kit 28", thin boards	120	L-010-0522	MYPlan Multi Job Optimization	99
L-009-0284	Tool QFP 19mm	132	L-010-0733	Machine Upgrade Kit for TEX	79
L-009-0287	Tool bank	134	L-011-0044	DVS For TP9-4/TP11 Installation Kit	26
L-009-0296	Double flat pipe nozzle	125	L-011-0047	DVS For TP12/18 Installation Kit	26
L-009-0297	Gripper tool	129	L-011-0048	DVS For TP12/18 Upgrade From SVS	27
L-009-0301B	Double suction cup tool	133	L-011-0049	DVS For TP9-4/TP11 Upgrade From SVS	27
L-009-0308	Bellow suction cup tool	133	L-011-0052	OVS-SVS Upgrade TP9-2U	26
			L-011-0053	OVS-SVS Upgrade TP9-4/11	26
			L-011-0054	OVS-SVS Upgrade TP12/18	26
			L-012-0011E	Tool A12	86
			L-012-0012F	Tool A13	87

Part Number Index

Part no.	Product name	Page	Part no.	Product name	Page
L-012-0014D	Tool A23	87	L-014-0269	Tubefork LCC 28-32	82
L-012-0015D	Tool A24	87	L-014-0303	Tubefork DIP24	82
L-012-0016E	Tool A34	88	L-014-0363	Tube fork 2xSO8+3xSO14-16	82
L-012-0017C	Tool B12	111	L-014-0364	Tube fork 5xSO8	82
L-012-0018C	Tool B13	111	L-014-0403	Flex Feeder 1 x 12 mm	72
L-012-0019C	Tool B14	111	L-014-0406	Flex Feeder 4 x 8 mm	72
L-012-0020E	Tool B23	89	L-014-0410	Flex Feeder 2 x 8 mm	72
L-012-0021E	Tool B24	89	L-014-0415	Flex Feeder 12 + 16 mm	73
L-012-0022E	Tool B34	89	L-014-0416	Flex Feeder 1 x 8 mm	72
L-012-0023C	Tool C12	111	L-014-0417	Flex Feeder 2 x 12 mm	72
L-012-0024C	Tool C13	111	L-014-0418	Flex Feeder 2 x 16 mm	73
L-012-0026D	Tool C23	88	L-014-0419	Flex Feeder 1 x 24 mm	73
L-012-0109C	Tool A14S	87	L-014-0421	Flex Feeder 1 x 32 mm	74
L-012-0115	Gripper tool	126	L-014-0422	Flex Feeder 1 x 44 mm	74
L-012-0117	Gripper tool	129	L-014-0423	Flex Feeder 1 x 56 mm	74
L-012-0379	Magnet tool	125	L-014-0432	Tubefork Multi SO-8	82
L-012-0383C	Tool C23S	88	L-014-0433	Tubefork Multi SO-14/ 18	82
L-012-0513	Set of 8 Tools H01 Rev.1	91	L-014-0434	Tubefork Multi SO-24/28	82
L-012-0514	Set of 8 Tools H02 Rev.1	91	L-014-0435	Tubefork Multi PLCC 20	82
L-012-0520	Set of 8 Tools H03 Rev.1	91	L-014-0436	Tubefork Multi PLCC 28	82
L-012-0533	Set of 8 Tools H01 Rev.2	91	L-014-0437	Tubefork Multi SOMC-14/16	82
L-012-0534	Set of 8 Tools H02 Rev.2	92	L-014-0438	Tubefork Mix SO-8/SO-14,18	82
L-012-0535	Set of 8 Tools H03 Rev.2	92	L-014-0439	Tubefork Multi PLCC 20 split	82
L-012-0551B	Tool A23S	87	L-014-0440	Tubefork Multi SOJW-40	82
L-012-0552B	Tool A24S	88	L-014-0441	Tubefork Mix 2xDIP8 + 1xPLCC20	82
L-012-0572	Set of 8 Tools H04	92	L-014-0442E	Tape Magazine TMD Flex	71
L-012-0574	HYDRA tool for Midas	131	L-014-0710B	Large Reel Attachment	69
L-012-0802	Tool C14	86	L-014-0720	Upgrade Kit from GS1 to GS2	110
L-012-0816	Set of 8 tools H06	92	L-014-0721	Upgrade kit GS2 TP9/11	110
L-012-0824	Set of 8 Tools H05	92	L-014-0722	Upgrade kit GS2 TP12/18	110
L-012-0845	Tool C24 flat nozzle 3.5 mm x 1.0 mm	89	L-014-0749	Flex Magazine Conversion Kit - D	75
L-012-0846	Tool C24 flat nozzle 5.0 mm x 1.0 mm	90	L-014-0771	Tape Clip Magazine 150 mm	66
L-012-0847	Tool C24 flat nozzle 7.2 mm x 1.2 mm	90	L-014-0772	Tape Clip Magazine 75 mm	66
L-012-0848	Tool C24 melf 3.3	90	L-014-0810	Tubefork SO32	82
L-012-0849	Tool C24 melf 4.5	90	L-014-0812	Tubefork PLCC 84 Socket	82
L-012-0850	Tool C24 melf 7.7	91	L-014-0813	Tubefork SOJW 32	82
L-012-0884	Tool B12 chip 01005	86	L-014-0814	Tubefork SOJW 32 Wide Stick	82
L-014-0001D	Tape Magazine TM8C	65	L-014-0815	Tubefork PLCC 44 Socket	82
L-014-0004E	Tape Magazine TM24D	65	L-014-0816	Tubefork SOW-8	82
L-014-0006D	Tape Magazine TM1216C	65	L-014-0817	Tubefork PLCC 20 Socket	82
L-014-0007E	Tape Magazine TM32D	65	L-014-0818	Tubefork PLCC 28/ 32 Socket	82
L-014-0008E	Tape Magazine TM44D	66	L-014-0819	Tubefork SO24	82
L-014-0009E	Tape Magazine TM5632D	66	L-014-0820	Tubefork SO24/33 Wide Stick	82
L-014-0016B	Vibratory Magazine VMF30	80	L-014-0821	Tubefork SOJ 28	82
L-014-0060	Tubefork PHILIPS 1	82	L-014-0822	Tubefork PLCC 68 Socket	82
L-014-0062D	Tubefork SO-8 (Plastic)	82	L-014-0823	Tubefork VSO 32	82
L-014-0063	Tubefork PLCC 52	82	L-014-0824	Tubefork D-Pack	82
L-014-0064D	Tubefork SO-20/28 (Plastic)	82	L-014-0826	Tubefork for Connector	82
L-014-0065D	Tubefork SO-14,/16	82	L-014-0827	Tubefork for Battery Contact	82
L-014-0066	Tubefork PLCC 18	82	L-014-0828	Tubefork SOP 16, QSOP 16	82
L-014-0067	Tubefork PLCC 20	82	L-014-0829	Tubefork for Amp 15	82
L-014-0068	Tubefork PLCC 28 / 32	82	L-014-0830	Tubefork SOP 14	82
L-014-0069	Tubefork PLCC 44	82	L-014-0831	Tubefork SOP 14 Wide Stick	82
L-014-0070	Tubefork PLCC 68	82	L-014-0832	Tubefork SOP 8	82
L-014-0071	Tubefork PLCC 84	82	L-014-0839	Tubefork SOP 32	82
L-014-0076	Tubefork SO-14W	82	L-014-0840	Tubefork SOL 28	82
L-014-0077	Stick Stopper 9.5/4.5 - VM30	82	L-014-0848	Large Reel Attachment Axle Set	69
L-014-0087	Tubefork SOMC 14-16	82	L-014-0855	Tape Clip Magazine Rail	66
L-014-0088	Tubefork DIL-6	82	L-014-0865	TM8B Rev.1 Upgrade	70
L-014-0126B	Tubefork Multi LCCC 18-28	82	L-014-0866	TM8C Rev.1 Upgrade	70
L-014-0260	Large Reel Conversion Kit	68	L-014-0867	TM12C Rev.1 Upgrade	70
L-014-0268	Tubefork LCC 18-28, SOJ24-26	82	L-014-0868	TM24C Rev.1 Upgrade	71
			L-014-0869	TM32C Rev.1 Upgrade	71
			L-014-0871	TM44, 56/32C Rev.1 Upgrade	71
			L-014-0872	TM16C Rev.1 Upgrade	71

Part Number Index

Part no.	Product name	Page	Part no.	Product name	Page
L-014-0873	TM12/16C Rev.1 Upgrade	71	L-024-0195	TEX Pallet Narrow, 2 pcs	78
L-014-0905	TM32C > D Upgrade	71	L-024-0196	TEX Wide Pallet	78
L-014-0906	TM44C > D Upgrade	71	L-025-0001	Tray Wagon Magazine TWM	79
L-014-0907	TM56/32C > D Upgrade	71	L-025-0072	1 Module Table for TWM	79
L-014-0912	Flex Feeder 1 x 16 mm	73	L-025-0073	2 Module Table for TWM	79
L-014-0914	TMFC Rev.2 Upgrade	70	L-025-0074	3 Module Table for TWM	79
L-014-0915	TMFC Rev.1 to Rev.2 Upgrade	70	L-025-0215	Manual Load Adapter 500T2	35
L-014-1319	Agilis Feeder 8 4.7	63	L-025-0241	Wide board support 500T2	35
L-014-1320	Agilis Feeder 8 4.0	63	L-040-0011B	Light Tower MY-Series	106
L-014-1321	Agilis Feeder 8 5.4	63	L-040-0046C	Upgrade to Conveyor 400PT MY-Series and TP-Series	25
L-014-1358	Agilis Bin13"	67	L-040-0046C	Upgrade to Conveyor 400PT MY-Series and TP-Series	25
L-014-1359	Agilis Large Reel Attachment	67	L-040-0047C	Upgrade to Conveyor 500T2 MY-Series and TP-Series	25
L-014-1361	Agilis Storage Box	68	L-040-0047C	Upgrade to Conveyor 500T2 MY-Series and TP-Series	25
L-014-1395	Agilis Feeder 8 3.7	63	L-040-0047C	Upgrade to Conveyor 500T2 MY-Series and TP-Series	25
L-014-1458	Flex Feeder 1 x 72 mm	75	L-040-0067	ML3 Upgrade Kit for MY 288/468	14
L-014-1483	Generic Feeder Interface, GFI	80	L-040-0068	ML4 Upgrade Kit for MY 288/468	14
L-014-1490	Agilis Feeder 12 8.5	64	L-040-0069	ML5 Upgrade Kit for MY 288/468	14
L-014-1492	Agilis Feeder 16 12.5	64	L-040-0070	ML6 Upgrade Kit for MY 288/468	14
L-014-1500	Flex Feeder 32 - 136 mm	75	L-040-0078	MY9	4
L-014-1552	Agilis Feeder 12 Adjustable	64	L-040-0079	MY12	4
L-014-1553	Agilis Feeder 16 Adjustable	64	L-040-0080	MY15	4
L-014-1561	Agilis LM8	62	L-040-0081	MY19	5
L-014-1562	Agilis LM1216	62	L-040-0125	TPSys 1.6 Upgrade Kit TP	96
L-014-1568	Agilis Bin 7"	66	L-040-0127D	TPSys 2.5 Upgrade Kit	96
L-014-1569	Agilis Flexbin 13"	67	L-040-0468	LCD Monitor upgrade kit MY9-MY15	20
L-014-1570	Agilis Bin Wall	67	L-040-0471	LCD Monitor upgrade kit MY19	20
L-014-1572	Tape Seal 1216	68	L-040-0496	HYDRA Speedmount installation kit	15
L-014-1600	Tape Seal 8	68	L-040-0497	HYDRA Speedmount 21K upgrade kit	16
L-014-1623	Agilis Feeder Rack	68	L-040-0498	HYDRA Speedmount ATE upgrade kit	25
L-015-0009B	ML Board Edge Support TP	34	L-040-0498	HYDRA Speedmount ATE upgrade kit	25
L-015-0010B	T-Series Support Pin	35	L-040-0499	HYDRA Speedmount ER upgrade kit	16
L-015-0013B	Fixture Plate Holder	34	L-040-0508	Single LVS Installation Kit	17
L-015-0014	Fixture Plate 11 x 18"	34	L-040-0509	Second LVS Installation Kit	17
L-015-0026	Fixture Plates. Set of 10	34	L-040-0583	Printer 230V with cables	106
L-015-0256C	Support Pin 500T2/400PT	34	L-041-0213B	DVS For MY-Series Upgrade From SVS	17
L-015-0277B	Y Wagon Tray Holder	79	L-044-0001	Flexible Glue Station 2	110
L-015-0315	Y Wagon Table Upgrade	24	L-044-0005	Flexible Glue Station 2 Machine Kit	110
L-015-0367	Y Wagon Table 288	24	L-045-0485	Manual Load Adapter T5	36
L-015-0368	Y Wagon Table 348	24	L-045-0486	Manual Load Adapter T6	36
L-015-0369	Y Wagon Table 468	24	L-045-0539	Manual Load Adapter T4	35
L-015-0370	Y Wagon Table 528	24	L-045-0540	Manual Load Adapter T3	35
L-015-0375	Y Wagon Table Upgrade 288 for HYDRA	24	L-049-0485	MCU Upgrade Kit	27
L-015-0376	Y Wagon Table Upgrade 468 for HYDRA	25	L-049-0485	MCU Upgrade Kit	27
L-015-0444	ML Board Edge Support 0.5 - 4 mm	34	P-009-0435	MY9 Extended	5
L-015-1023	ML Support Pin 0.5 - 4 mm	34	P-009-0436	MY12 Extended	5
L-015-1547	ML Board Edge Support 8 - 10 mm	34	P-009-0437	MY15 Extended	5
L-015-1548	ML Support Pin 8 - 10 mm	34	P-009-0438	MY19 Extended	5
L-015-1561	ML Board Edge Support 3 - 8 mm	34	U-024-0006	TEX Magnet	78
L-015-1562	ML Support Pin 3 - 8 mm	34			
L-017-0048	Board Destacker	46			
L-019-1032	VGA FOR TP12/18	29			
L-019-1033	VGA FOR TP9-1/2/3/4 & 11 W CB1	29			
L-019-1034	VGA FOR TP9-2/4 & TP11 W CB2	29			
L-020-0005C	SVS For TP12/18-UFP Installation Kit	26			
L-020-0067	Color Monitor Upgrade TP12/18	29			
L-020-0090-4.0	CAD Conversion 4.0	99			
L-020-0091-4.0	CAD Conversion 4.0 upgrade from 3.X	99			
L-024-0100B	TEX Tray Exchanger	77			
L-024-0190	TEX Pallet Narrow JEDEC, 2 pcs	78			
L-024-0192	TEX Narrow Cassette	77			
L-024-0193	TEX Wide Cassette	77			
L-024-0194	TEX Pallet Narrow Spring, 2 pcs	78			

Alphabetical Index

Product name	Part no.	Page	Product name	Part no.	Page
1 Module Table for TWM	L-025-0072	79	Auto Width Control Unit Option	K-017-0488	53
2 Module Table for TWM	L-025-0073	79	Auto Width Inline Option	K-017-0487	53
2 Monitors	03670	96	Barcode Combo Sticker	D-014-1482	106
2PT1 RCD Verifier	0501	27	TM12/1216/16		
2PT1 RCD Verifier	0501	27	Barcode Combo Sticker TM24	D-014-1483	106
2PT1 RCD Verifier	0501	27	Barcode Combo Sticker TM32	D-014-1484	106
3 Module Table for TWM	L-025-0074	79	Barcode Combo Sticker TM44/5632	D-014-1485	106
3 Monitors	03671	96	Barcode Combo Sticker TM8/8F/FLEX	D-014-1481	106
3PT1 RCDT Verifier	0502	27	Barcode Combo Sticker VMF30	D-014-1486	106
3PT1 RCDT Verifier	0502	27	Barcode Prefix Sticker 1 (TPSys 2.3 or older)	D-014-1487	106
3PT1 RCDT Verifier	0502	27	Barcode Prefix Sticker 2 (TPSys 2.4 or later)	D-014-1937	106
400PT Hood Kit	00031	25	Barcode Reader for Conveyor	K-017-0191	56
400PT Hood Kit	00031	25	Option		
400PT Inline Conveyor	00030	7	Barcode Reader Magazine 110/120V	L-010-0131	106
500T2 Hood Kit	00041	25	60Hz		
500T2 Hood Kit	00041	25	Barcode Reader Magazine 230V	L-010-0130	106
500T2 Inline Conveyor	0004	7	50Hz		
Accuflex Screen Printer Interface	K-040-0221	102	Barcode Scanner Cordless	L-010-0377	97
Additional Magazine Conveyor Unit	K-017-0598	54	Barcode Scanner RS232	L-010-0380	98
Adjustable Conveyor Speed Option	K-017-0127	52	Barcode Software	0506	28
Adjustable Sensor Arm Upgrade	K-017-0500	55	Barcode Software	0506	28
Adjustable Shelf 1000	K-017-0140	58	Barcode Software	0506	28
Adjustable Shelf 1500	K-017-0139	58	Bellow suction cup tool	L-009-0408	132
Agilis Bin13"	L-014-1358	67	Bellow suction cup tool	L-009-0308	133
Agilis Bin 7"	L-014-1568	66	Board Destacker	L-017-0048	46
Agilis Bin Wall	L-014-1570	67	Board Inverter	K-017-0189	47
Agilis Feeder 12 8.5	L-014-1490	64	Board Train Function T3/T4	K-017-0531	55
Agilis Feeder 12 Adjustable	L-014-1552	64	Board Train Function T5/T6	K-017-0484	55
Agilis Feeder 16 12.5	L-014-1492	64	Board Transfer System	K-017-0187	47
Agilis Feeder 16 Adjustable	L-014-1553	64	CAD Accel PCAD, Tango, EDA Imp	K-040-0024	101
Agilis Feeder 8 3.7	L-014-1395	63	CAD Cadence Allegro	K-040-0027	101
Agilis Feeder 8 4.0	L-014-1320	63	CAD C-Link DIF	K-040-0016	101
Agilis Feeder 8 4.7	L-014-1319	63	CAD Contact Systems CS3 Import	K-040-0112	101
Agilis Feeder 8 5.4	L-014-1321	63	CAD Conversion 4.0	L-020-0090-4.0	99
Agilis Feeder Rack	L-014-1623	68	CAD Conversion 4.0 upgrade from 3.X	L-020-0091-4.0	99
Agilis Flexbin 13"	L-014-1569	67	CAD EE Designer 3 Import	K-040-0098	101
Agilis Large Reel Attachment	L-014-1359	67	CAD Europlacer Import	K-040-0113	101
Agilis LM1216	L-014-1562	62	CAD Fabmaster Import	K-040-0129	101
Agilis LM8	L-014-1561	62	CAD Fuji Source Program Import	K-040-0115	101
Agilis Storage Box	L-014-1361	68	CAD GenCAD v1.4	K-040-0018	101
All CAD Import Formats	K-040-0069	101	CAD Incases Import	K-040-0110	101
All Machine Import Formats	K-040-0032	101	CAD Intergraph Pantheon Design	K-040-0031	101
Amistar Axial Inserter	K-040-0081	102	CAD Intergraph Veribest GenCAD	K-040-0029	101
Amistar Coordinate Download	K-040-0033	102	CAD Mentor Graphics	K-040-0021	101
Amistar DIP Inserter	K-040-0082	102	CAD OrCAD Import	K-040-0028	101
ASCII Custom Output Interface	K-040-0034	102	CAD PADS PowerPCB, Perform, 2000, Work	K-040-0020	101
Assembleon FCM/ACM Interface	K-040-0222	102	CAD Panapro PCB Import	K-040-0143	101
Assembleon GEM LINE Interface	K-040-0223	102	CAD Panasonic POS Import	K-040-0116	101
Asymtek Dispensing Interface	K-040-0083	102	CAD PCAD Import	K-040-0023	101
AT-CPU1 PF2 with CP54	03640	96	CAD Philips FTIP-1 Import	K-040-0114	101
AT-CPU2 PF1 with CP5	03604	17	CAD Protel Import	K-040-0026	101
AT-CPU2 PF1 with CP5	03604	17	CAD Sanyo/Universal Chipsh Im	K-040-0118	101
AT-CPU2 PF1 with CP5	03604	17	CAD SCI Cards Import	K-040-0111	101
AT-CPU2 PF2 with CP5	03642	96	CAD Siemens Program Import	K-040-0117	101
AT-CPU2 PF2 with CP5	03642	96	CAD Subcon's Pckg (Gerber + ASCII Import)	K-040-0013	101
AT-CPU2 PF2 with CP5	03642	96	CAD Supermax	K-040-0144	101
AT-CPU2 PF2 with CP54	03641	96	CAD Tango for DOS	K-040-0025	101
Auto Detect and Communication	K-017-0597	57	CAD Technomatix-Unicam WF Imp	K-040-0107	101
Loader to Unloader			CAD THEDA BY INCASES	K-040-0070	101
Auto Detection of PCBs in Magazine	K-017-0596	56	CAD ULTIBOARD	K-040-0071	101
Automatic Loader	K-017-0561	45			
Automatic Reloader	K-017-0563	45			
Automatic Unloader	K-017-0562	45			
Autosplice Programming Interface	K-040-0176	102			

Alphabetical Index

Product name	Part no.	Page	Product name	Part no.	Page
CAD Valor ODB++ Import	K-040-0109	101	Extensible Shelf 1000	K-017-0138	58
CAD Zuken Visula and Cadstar	K-040-0022	101	Extensible Shelf 1500	K-017-0137	58
Camalot Full Line Disp Interface	K-040-0072	102	FIFO/LIFO Buffer Unit	K-017-0188	48
Celmacs Interface	K-040-0035	102	Finnish EU STD	0310	12
Christopher AOI Interface	K-040-0085	102	Fixture Plate 11 x 18"	L-015-0014	34
Citizen Interface	K-040-0036	102	Fixture Plate Holder	L-015-0013B	34
Color Monitor Upgrade TP12/18	L-020-0067	29	Fixture Plates. Set of 10	L-015-0026	34
Color Monitor Upgrade TP9-1/2/3	L-010-0117	29	Flat pipe nozzle micro	L-009-0357	125
Contact Systems 3S/3AV Interface	K-040-0037	102	Flex Feeder 12 x 16 mm	L-014-0415	73
Contact Systems 3Z Series Interface	K-040-0057	102	Flex Feeder 1 x 12 mm	L-014-0403	72
Contact Systems CS-400 Interface	K-040-0038	102	Flex Feeder 1 x 16 mm	L-014-0912	73
Conveyor 500T2 with extension Kit 24"	L-009-0147	120	Flex Feeder 1 x 24 mm	L-014-0419	73
Conveyor 500T2 with extension Kit 28", thick boards	L-009-0269	120	Flex Feeder 1 x 32 mm	L-014-0421	74
Conveyor 500T2 with extension Kit 28", thin boards	L-009-0281	120	Flex Feeder 1 x 44 mm	L-014-0422	74
Conveyor Floor Braces	K-017-0476	53	Flex Feeder 1 x 56 mm	L-014-0423	74
Conveyor Slide Extention Option	K-017-0499	55	Flex Feeder 1 x 72 mm	L-014-1458	75
C-Profiled Stand 1000	K-017-0131	54	Flex Feeder 1 x 8 mm	L-014-0416	72
C-Profiled Stand 1500	K-017-0130	54	Flex Feeder 2 x 12 mm	L-014-0417	72
Crate MY12	K-040-0341	114	Flex Feeder 2 x 16 mm	L-014-0418	73
Crate MY15	K-040-0342	114	Flex Feeder 2 x 8 mm	L-014-0410	72
Crate MY19	K-040-0343	114	Flex Feeder 32 - 136 mm	L-014-1500	75
Crate MY9	K-040-0340	114	Flex Feeder 4 x 8 mm	L-014-0406	72
CR Technologies AOI Interface	K-040-0086	102	Flexible Glue Station 2	L-044-0001	110
D 190/100V 3 phase US	0230	12	Flexible Glue Station 2 for MY-Series	04500	12
D 190/110V 3 phase EU	0210	12	Flexible Glue Station 2 Machine Kit	L-044-0005	110
D 200/115V 3 phase EU	0211	12	Flex Magazine Conversion Kit - D	L-014-0749	75
D 200V 3 phase JPN	0220	12	Foot Rest	K-017-0142	54
D 210/121V 3 phase EU	0212	12	French EU STD	0306	12
D 210/121V 3 phase US	0232	12	French US STD	0302	12
D 215/125V 3 phase EU	0213	12	Fuji F4G	K-040-0146	102
D 220/127V 3 phase EU	0214	12	Fuji Flexa Interface	K-040-0177	102
D 225/130V 3 phase EU	0215	12	Fuji Source Program Interface	K-040-0147	102
D 230/133V 3 phase EU	0216	12	GenCAD Export Module	K-040-0090	102
D 235/136V 3 phase EU	0217	12	GenCAD Export Output Fujicam	K-040-0076	102
D 240/140V 3 phase EU	0218	12	Generic Feeder Interface, GFI	L-014-1483	80
D 240/140V 3 phase US	0238	12	German EU STD	0308	12
D 250/145V 3 phase EU	0219	12	GPD Adhesive Dispensing Interface	K-040-0148	102
D 250/145V 3 phase US	0239	13	Gripper tool	L-012-0115	126
Danish EU STD	0315	12	Gripper tool	L-009-0051	126
Document Holder Magazine Trolley	K-017-0290	70	Gripper tool	L-009-0163	126
Double flat pipe nozzle	L-009-0296	125	Gripper tool	L-009-0089	126
Double flat pipe nozzle	L-009-0393	126	Gripper tool	L-009-0111	127
Double suction cup tool	L-009-0434	132	Gripper tool	L-009-0449	127
Double suction cup tool	L-009-0301B	133	Gripper tool	L-009-0445	127
Dutch EU STD	0312	12	Gripper tool	L-009-0419	128
DVS For MY-Series Upgrade From SVS	L-041-0213B	17	Gripper tool	L-009-0420	128
DVS For TP12/18 Installation Kit	L-011-0047	26	Gripper tool	L-009-0417	128
DVS For TP12/18 Upgrade From SVS	L-011-0048	27	Gripper tool	L-009-0400	129
DVS For TP9-4/TP11 Installation Kit	L-011-0044	26	Gripper tool	L-009-0297	129
DVS For TP9-4/TP11 Upgrade From SVS	L-011-0049	27	Gripper tool	L-012-0117	129
Dynapert Axial Inserter	K-040-0087	102	Gripper tool, moonstyle	L-009-0452	127
Dynapert DIP Inserter	K-040-0088	102	Gripper tool round jaws	L-009-0418	128
Dynapert I-2200 Interface	K-040-0039	102	Gripper tool with thin jaws	L-009-0416	129
ECM 96 Interface	K-040-0040	102	Gripper tool with thin jaws	L-009-0412	129
Ekra screen printer interface	K-040-0145	102	Heller Oven Interface	K-040-0225	102
End of Line Conveyor Option	K-017-0455	52	Holder cover for Flex feeder 32	D-014-1923	76
English EU STD	0305	12	Holder cover for Flex feeder 44	D-014-1924	76
English US STD	0301	12	Holder cover for Flex feeder 56	D-014-1925	76
ESD Insert for Trolley Shelf	K-017-0292	70	Holder cover for Flex feeder 72	D-014-1926	76
Europlacer Interface	K-040-0073	102	Holder cover TM12	D-014-1728	70
			HYDRA 14k MY12	04011	8
			HYDRA 14k MY15	04011	8
			HYDRA 14k MY19	04011	8
			HYDRA 14k MY9	04011	8
			HYDRA 21k ER For LVS MY12	04027	15

Alphabetical Index

Product name	Part no.	Page	Product name	Part no.	Page
HYDRA 21k ER For LVS MY15	04037	15	Manual Load Adapter T3	L-045-0540	35
HYDRA 21k ER For LVS MY19	04047	15	Manual Load Adapter T4	L-045-0539	35
HYDRA 21k ER For LVS MY9	04017	15	Manual Load Adapter T5	L-045-0485	36
HYDRA 21k MY12	04020	9	Manual Load Adapter T6	L-045-0486	36
HYDRA 21k MY12	04024	15	Manual Loader Light	K-017-0450	46
HYDRA 21k MY12, ER LVS	04022	9	Manual Reloader Light	K-017-0457	47
HYDRA 21k MY12, ER T-LVS	04026	10	Manual Unloader Light	K-017-0451	46
HYDRA 21k MY15	04030	9	MCU Upgrade Kit	L-049-0485	27
HYDRA 21k MY15	04034	15	MCU Upgrade Kit	L-049-0485	27
HYDRA 21k MY15, ER LVS	04032	9	MELF tool, Micro	L-009-0230B	130
HYDRA 21k MY15, ER T-LVS	04036	10	Midas Upgrade Kit	L-010-0457	19
HYDRA 21k MY19	04040	9	MIMOT SMT Interface	K-040-0154	102
HYDRA 21k MY19	04044	15	ML3 Manual Load	0005	7
HYDRA 21k MY19, ER LVS	04042	9	ML3 Upgrade Kit for MY 288/468	L-040-0067	14
HYDRA 21k MY19, ER T-LVS	04046	10	ML4 Manual Load	0006	7
HYDRA 21k MY9	04010	9	ML4 Upgrade Kit for MY 288/468	L-040-0068	14
HYDRA 21k MY9	04014	15	ML5 Manual Load	0007	8
HYDRA 21k MY9, ER LVS	04012	9	ML5 Upgrade Kit for MY 288/468	L-040-0069	14
HYDRA 21k MY9, ER T-LVS	04016	10	ML6 Manual Load	0008	8
HYDRA Speedmount 21K upgrade kit	L-040-0497	16	ML6 Upgrade Kit for MY 288/468	L-040-0070	14
HYDRA Speedmount ATE upgrade kit	L-040-0498	25	ML Board Edge Support 0.5 - 4 mm	L-015-0444	34
HYDRA Speedmount ATE upgrade kit	L-040-0498	25	ML Board Edge Support 3 - 8 mm	L-015-1561	34
HYDRA Speedmount ER upgrade kit	L-040-0499	16	ML Board Edge Support 8 - 10 mm	L-015-1547	34
HYDRA Speedmount installation kit	L-040-0496	15	ML Board Edge Support TP	L-015-0009B	34
HYDRA tool for Midas	L-012-0574	131	ML Support Pin 0.5 - 4 mm	L-015-1023	34
In-line Barcode Reader Light Conv	K-017-0489	56	ML Support Pin 3 - 8 mm	L-015-1562	34
In-line Barcode Reader T3/T4 Conv	K-017-0537	56	ML Support Pin 8 - 10 mm	L-015-1548	34
In-line Barcode Reader T5/T6 Conv	K-017-0490	56	MOT3-Z Upgrade for Hydra 2D on MY19	L-010-0403	16
Inspection Option	K-017-0285	52	Motorised Width Adjustment Option	K-017-0124	52
Intelligent Reas Sys AOI Interface	K-040-0091	102	MPI/Manix Interface	K-040-0043	102
Intelliplace Interface	K-040-0042	102	MPM400-500/SMTech Printers	K-040-0048	102
Italian EU STD	0311	12	Multi dot glue tool	L-009-0036	124
Japanese US STD	0316	12	Multitronics Interface	K-040-0044	102
Juki HLC/2000 Series Interface	K-040-0149	102	MY12	L-040-0079	4
Kernel pipe tool	L-009-0345	131	MY12 Extended	P-009-0436	5
KME Chipshooter Interface	K-040-0092	102	MY15	L-040-0080	4
KME PS245 Interface	K-040-0153	102	MY15 Extended	P-009-0437	5
Label Printer for MYLabel	L-010-0383	98	MY19	L-040-0081	5
Labels 53x55mm - Case of 18 rolls	L-010-0386	98	MY19 Extended	P-009-0438	5
Large Reel Attachment	L-014-0710B	69	MY9	L-040-0078	4
Large Reel Attachment Axle Set	L-014-0848	69	MY9 Extended	P-009-0435	5
Large Reel Conversion Kit	L-014-0260	68	MYCam, All Import Interfaces	K-040-0005	100
LCD Monitor upgrade kit MY19	L-040-0471	20	MYCAM + ACCEL EDA TANGO PCAD	K-040-0301	100
LCD Monitor upgrade kit MY9-MY15	L-040-0468	20	MYCAM + CADENCE ALLEGRO	K-040-0304	100
Light Tower	0491	12	IMPORT		
Light Tower MY-Series	L-040-0011B	106	MYCAM + C-LINK DIF IMPORT	K-040-0306	100
Light Tower Option	K-017-0472	53	MYCAM + EE DESIGNER 3 IMPORT	K-040-0307	100
Light tower TP12/18	L-010-0128B	106	MYCAM + FABMASTER CAD IMPORT	K-040-0308	100
Light Tower TP9-2/3	L-010-0124B	106	MYCAM + GENCAD V. 1.4 IMPORT	K-040-0309	100
Light Tower TP9-2U	L-010-0144B	106	MYCAM + INCASES CAD IMPORT	K-040-0311	100
Light tower TP9-4/11	L-010-0127B	106	MYCAM + INTERGRAPH PANTHEON	K-040-0312	100
Logging El. Measurement Software	0512	27	MYCAM + INTERGRAPH VERIBEST	K-040-0313	100
Logging El. Measurement Software	0512	27	MYCAM + MACHINE IMPORT SUITE	K-040-0338	100
Logging El. Measurement Software	0512	27	MYCAM + MENTOR GRAPHICS	K-040-0315	100
Low force tool	L-009-0071	130	IMPORT		
Machine Upgrade Kit for TEX	L-010-0733	79	MYCAM + ORCAD IMPORT	K-040-0317	100
Machine Vision Prod AOI Interface	K-040-0093	102	MYCAM + PADS POWERPCB ETC	K-040-0318	100
Magazine Trolley	K-017-0286	69	MYCAM + PANAPRO PCB IMPORT	K-040-0319	100
Magnet tool	L-012-0379	125	MYCAM + PCAD PDIF IMPORT	K-040-0320	100
Manual Gate Conveyor	K-017-0186	48	MYCAM + PROTEL CAD IMPORT	K-040-0321	100
Manual Load Adapter 500T2	L-025-0215	35	MYCAM + SCI CARDS IMPORT	K-040-0323	100
			MYCAM + SUBCONTRACTORS	K-040-0324	100
			PACKAGE		

Alphabetical Index

Product name	Part no.	Page	Product name	Part no.	Page
MYCAM + SUPERMAX CAD IMPORT	K-040-0325	100	Sanyo TCM Chipshooter Interface	K-040-0047	102
MYCAM + TANGO FOR DOS IMPORT	K-040-0302	100	Sanyo TIM Flexible Plac. Interface	K-040-0060	102
MYCAM + TECNOMATIX-UNICAM PDW IMPORT	K-040-0326	100	Second LVS Installation Kit	L-040-0509	17
MYCAM + THEDA INCASES IMPORT	K-040-0327	100	Set of 8 Tools H01 Rev.1	L-012-0513	91
MYCAM + ULTIBOARD CAD IMPORT	K-040-0328	100	Set of 8 Tools H01 Rev.2	L-012-0533	91
MYCAM + VALOR ODB++ IMPORT	K-040-0329	100	Set of 8 Tools H02 Rev.1	L-012-0514	91
MYCAM + ZUKEN VISULA + CADSTAR	K-040-0330	100	Set of 8 Tools H02 Rev.2	L-012-0534	92
MYCam 2nd License	K-040-0064	101	Set of 8 Tools H03 Rev.1	L-012-0520	91
MYCam 3rd License	K-040-0065	101	Set of 8 Tools H03 Rev.2	L-012-0535	92
MYCam 4th License	K-040-0066	101	Set of 8 Tools H04	L-012-0572	92
MYCam 5th License	K-040-0067	101	Set of 8 Tools H05	L-012-0824	92
MYCam 6th License	K-040-0068	101	Set of 8 tools H06	L-012-0816	92
MYCam Documentation	K-040-0009	100	Shared Databases	0503	28
MYCam Reporting System	K-040-0011	101	Shared Databases	0503	28
MYCam Viewer	K-040-0010	100	Shared Databases	0503	28
MYCam Viewer Site License	K-040-0063	101	Siemens HS Series Interface	K-040-0075	102
MYDATA Machine Interface	K-040-0226	102	Siemens Siplace Interface	K-040-0074	102
MYLabel 4 Kit w Cordless Scanners	L-010-0395	97	Siemens SIPLACE PRO Interface	K-040-0155	102
MYLabel 4 Software	L-010-0470	97	Single Linescan Vision System	04110	10
MYLabel 4 Upgrade from 2.X	L-010-0397	98	Single Loader	K-017-0590	44
MYLabel 4 Upgrade from 3.X	L-010-0398	99	Single LVS Installation Kit	L-040-0508	17
MYPlan Multi Job Optimization	L-010-0522	99	Single Unloader	K-017-0591	44
MYPlan Single Job Optimization	L-010-0521	99	SMEMA Board Available Detection Option	K-017-0475	53
Network License Manager	K-040-0217	101	SMEMA Machine Ready Detection Option	K-017-0474	53
Norweg. EU STD	0314	12	Spanish EU STD	0307	12
Omron AOI Machine Interface	K-040-0150	102	Spanish US STD	0303	12
Orbotech AOI Interface	K-040-0094	102	Speedline/MPM/Quad AVX/SMTech	K-040-0121	102
Overhead Conveyor 1000	K-017-0190	49	Start of Line Conveyor Option	K-017-0456	52
Overhead Lighting 1000	K-017-0132	57	Stick Stopper 9.5/4.5 - VM30	L-014-0077	82
Overhead Lighting 1000, 110V	K-017-0198	57	Support Pin 500T2/400PT	L-015-0256C	34
Overhead Lighting 500	K-017-0133	57	Suspension Rail 1000	K-017-0135	58
Overhead Lighting 500 110V	K-017-0284	57	Suspension Rail 1500	K-017-0134	58
OVS-SVS Upgrade TP12/18	L-011-0054	26	Swedish EU STD	0309	12
OVS-SVS Upgrade TP9-2U	L-011-0052	26	SVS For TP12/18-UFP Installation Kit	L-020-0005C	26
OVS-SVS Upgrade TP9-4/11	L-011-0053	26	SVS For TP9-2U Installation Kit	L-010-0211C	26
Panasonic Panasert Interface	K-040-0120	102	SVS For TP9-3/4/TP11 Installation Kit	L-010-0310C	26
PCB Magazine 297	K-017-0003	56	T3/T4 Conveyor 700	K-017-0517	42
PCB Magazine 310	K-017-0486	56	T3 Conveyor 1000	K-017-0518	42
PCB Magazine 390	K-017-0294	56	T3 Conveyor 1500	K-017-0519	43
PCB Magazine 397	K-017-0004	56	T3 Conveyor 2000	K-017-0520	43
PCB Magazine 460	K-017-0295	56	T3 Conveyor 2500	K-017-0521	43
PCB Magazine 510	K-017-0296	56	T3 Conveyor 500	K-017-0516	42
PC Server TPSys 2.x With UPS	L-010-0270	96	T3 Conveyor Package MY12/MY15	K-017-0527	40
Philips Ind. Aut. Via FTIP-2	K-040-0045	102	T3 Conveyor Package MY19	K-017-0528	40
Plastic ESD Storage Box	K-017-0136	54	T3 Conveyor Package MY9	K-017-0526	40
Portug. EU STD	0313	12	T3 Inline Conveyor	00103	6
Portug. US STD	0304	12	T3 MYSynergy Package MY12/MY12	K-017-0557	41
Power Rail 220 100/1500	K-017-0141	54	T3 MYSynergy Package MY9/MY12	K-017-0556	41
Pre-pick inspection	0514	29	T3 MYSynergy Package MY9/MY9	K-017-0555	41
Pre-pick inspection	0514	29	T4 Conveyor 1000	K-017-0522	43
Pre-pick inspection	0514	29	T4 conveyor 1500	K-017-0523	43
Printer 230V with cables	L-040-0583	106	T4 conveyor 2000	K-017-0524	43
Proline ML7	L-009-0263	118	T4 conveyor 2500	K-017-0525	43
Quad AVX Printer Prog Interface	K-040-0059	102	T4 Conveyor Package MY12/MY15	K-017-0529	40
Quad Systems Interface	K-040-0046	102	T4 Conveyor Package MY19	K-017-0530	40
Reloader Conveyor Light 1000	K-017-0478	50	T4 Inline Conveyor	00104	6
Reloader Conveyor Light 500	K-017-0477	50	T5 Inline Conveyor	00105	6
Ring tool	L-009-0459	130	T6 Inline Conveyor	00106	6
Ring tool	L-009-0458	130	Takaya Flying Probe/Fixture List Interface	K-040-0184	102
Rotatable Shaft Deep Flex	D-014-1155	75	Tape Clip Magazine 150 mm	L-014-0771	66
Royonix Machine Interface	K-040-0151	102	Tape Clip Magazine 75 mm	L-014-0772	66
Safety Cover + Safety Loop T3/T4	K-017-0532	52	Tape Clip Magazine Rail	L-014-0855	66
Samsung Interface	K-040-0095	102			

Alphabetical Index

Product name	Part no.	Page	Product name	Part no.	Page
Tape Magazine TM1216C	L-014-0006D	65	Tool C24 melf 4.5	L-012-0849	90
Tape Magazine TM24D	L-014-0004E	65	Tool C24 melf 7.7	L-012-0850	91
Tape Magazine TM32D	L-014-0007E	65	Tool double nozzle CC 11 MM	L-009-0360	122
Tape Magazine TM44D	L-014-0008E	66	Tool double nozzle CC 15	L-009-0346	123
Tape Magazine TM5632D	L-014-0009E	66	Tool double nozzle CC3.8 45D	L-009-0019	123
Tape Magazine TM8C	L-014-0001D	65	Tool double nozzle CC 4.1	L-009-0370	124
Tape Magazine TMD Flex	L-014-0442E	71	Tool double nozzle CC4.1 OD1.5	L-009-0350	123
Tape Seal 1216	L-014-1572	68	Tool double nozzle CC4.3MM	L-009-0457	122
Tape Seal 8	L-014-1600	68	Tool double nozzle CC 6	L-009-0151B	122
TDK Interface	K-040-0061	102	Tool double nozzle CC8 C24	L-009-0003	122
Telescopic Gate 1650	K-017-0185	49	Tool double nozzle MELF CC 4,8	L-009-0090	124
Test Fixture Coordinate Output	K-040-0049	102	Tool QFP 19mm	L-009-0284	132
TEX Magnet	U-024-0006	78	Tool QFP 22mm	L-009-0255	132
TEX Narrow Cassette	L-024-0192	77	Tool spring picking C24	L-009-0018	124
TEX Pallet Narrow, 2 pcs	L-024-0195	78	Tool Tray ESD Insert	K-017-0289	70
TEX Pallet Narrow JEDEC, 2 pcs	L-024-0190	78	Tool Tray Magazine Trolley	K-017-0287	69
TEX Pallet Narrow Spring, 2 pcs	L-024-0194	78	TPSys 1.6 Upgrade Kit TP	L-040-0125	96
TEX Tray Exchanger	L-024-0100B	77	TPSys 2.5 Upgrade Kit	L-040-0127D	96
TEX Wide Cassette	L-024-0193	77	TPSys SW Options Upgrade	L-010-0259	27
TEX Wide Pallet	L-024-0196	78	TPSys SW Options Upgrade	L-010-0259	27
Thin nozzle tool	L-009-0063	124	Transport-Buffer Conveyor T5/T6 1000	K-017-0271	50
TM12/16C Rev.1 Upgrade	L-014-0873	71	Transport-Buffer Conveyor T5/T6 1500	K-017-0272	50
TM12C Rev.1 Upgrade	L-014-0867	70	Transport-Buffer Conveyor T5/T6 2000	K-017-0273	50
TM16C Rev.1 Upgrade	L-014-0872	71	Transport-Buffer Conveyor T5/T6 2500	K-017-0274	50
TM24C Rev.1 Upgrade	L-014-0868	71	Transport-Buffer Narrow 400PT 1000	K-017-0200	49
TM32C > D Upgrade	L-014-0905	71	Transport-Buffer Narrow 400PT 1500	K-017-0270	50
TM32C Rev.1 Upgrade	L-014-0869	71	Transport Conveyor Light 1000	K-017-0446	50
TM44, 56/32C Rev.1 Upgrade	L-014-0871	71	Transport Conveyor Light 1500	K-017-0447	50
TM44C > D Upgrade	L-014-0906	71	Transport Conveyor Light 2000	K-017-0448	50
TM56/32C > D Upgrade	L-014-0907	71	Transport Conveyor Light 2500	K-017-0449	50
TM8B Rev.1 Upgrade	L-014-0865	70	Transport Conveyor Light 500	K-017-0445	50
TM8C Rev.1 Upgrade	L-014-0866	70	Transport Conveyor Package Light for MY12/15	K-017-0453	41
TMFC Rev.1 to Rev.2 Upgrade	L-014-0915	70	Transport Conveyor Package Light for MY19	K-017-0454	42
TMFC Rev.2 Upgrade	L-014-0914	70	Transport Conveyor Package Light for MY9	K-017-0452	41
Tool A12	L-012-0011E	86	Tray Wagon Magazine TWM	L-025-0001	79
Tool A13	L-012-0012F	87	Triple suction cup tool	L-009-0441	131
Tool A14S	L-012-0109C	87	TRP/BU Conv Package T5/T6 MY12/MY15	K-017-0493	42
Tool A23	L-012-0014D	87	TRP/BU Conv Package T5/T6 MY15	K-017-0491	41
Tool A23S	L-012-0551B	87	TRP/BU Conv Package T5/T6 MY19	K-017-0492	42
Tool A24	L-012-0015D	87	T-Series Support Pin	L-015-0010B	35
Tool A24S	L-012-0552B	88	Tube fork 2xSO8+3xSO14-16	L-014-0363	82
Tool A34	L-012-0016E	88	Tube fork 5xSO8	L-014-0364	82
Tool B12	L-012-0017C	111	Tubefork DIL-6	L-014-0088	82
Tool B12 chip 01005	L-012-0884	86	Tubefork DIP24	L-014-0303	82
Tool B13	L-012-0018C	111	Tubefork D-Pack	L-014-0824	82
Tool B14	L-012-0019C	111	Tubefork for Amp 15	L-014-0829	82
Tool B23	L-012-0020E	89	Tubefork for Battery Contact	L-014-0827	82
Tool B24	L-012-0021E	89	Tubefork for Connector	L-014-0826	82
Tool B34	L-012-0022E	89	Tubefork LCC 18-28, SOJ24-26	L-014-0268	82
Tool bank	L-009-0439B	133	Tubefork LCC 28-32	L-014-0269	82
Tool bank	L-009-0439	133	Tubefork Mix 2xDIP8 + 1xPLCC20	L-014-0441	82
Tool bank	L-009-0287	134	Tubefork Mix SO-8/SO-14,18	L-014-0438	82
Tool bank for very large tool	L-009-0442	133	Tubefork Multi LCCC 18-28	L-014-0126B	82
Tool C12	L-012-0023C	111	Tubefork Multi PLCC 20	L-014-0435	82
Tool C13	L-012-0024C	111	Tubefork Multi PLCC 20 split	L-014-0439	82
Tool C14	L-012-0802	86			
Tool C23	L-012-0026D	88			
Tool C23S	L-012-0383C	88			
Tool C24 flat nozzle 3.5 mm x 1.0 mm	L-012-0845	89			
Tool C24 flat nozzle 5.0 mm x 1.0 mm	L-012-0846	90			
Tool C24 flat nozzle 7.2 mm x 1.2 mm	L-012-0847	90			
Tool C24 melf 3.3	L-012-0848	90			

Alphabetical Index

Product name	Part no.	Page	Product name	Part no.	Page
Tube Fork Multi PLCC 28	L-014-0436	82	Upgrade step from TPSys 1.6/1.5	03232	96
Tube Fork Multi SO-14/ 18	L-014-0433	82	Upgrade step from TPSys 2.0	03233	96
Tube Fork Multi SO-24/28	L-014-0434	82	Upgrade step from TPSys 2.1	03234	96
Tube Fork Multi SO-8	L-014-0432	82	Upgrade step from TPSys 2.2	03235	96
Tube Fork Multi SOJW-40	L-014-0440	82	Upgrade step from TPSys 2.3	03236	96
Tube Fork Multi SOMC-14/16	L-014-0437	82	Upgrade step from TPSys 2.4	03237	96
Tube Fork PHILIPS 1	L-014-0060	82	Upgrade to Conveyor 400PT	L-040-0046C	25
Tube Fork PLCC 18	L-014-0066	82	MY-Series and TP-Series		
Tube Fork PLCC 20	L-014-0067	82	Upgrade to Conveyor 400PT	L-040-0046C	25
Tube Fork PLCC 20 Socket	L-014-0817	82	MY-Series and TP-Series		
Tube Fork PLCC 28 / 32	L-014-0068	82	Upgrade to Conveyor 500T2	L-040-0047C	25
Tube Fork PLCC 28/ 32 Socket	L-014-0818	82	MY-Series and TP-Series		
Tube Fork PLCC 44	L-014-0069	82	Upgrade to Conveyor 500T2	L-040-0047C	25
Tube Fork PLCC 44 Socket	L-014-0815	82	MY-Series and TP-Series		
Tube Fork PLCC 52	L-014-0063	82	VGA FOR TP12/18	L-019-1032	29
Tube Fork PLCC 68	L-014-0070	82	VGA FOR TP9-1/2/3/4 & 11 W CB1	L-019-1033	29
Tube Fork PLCC 68 Socket	L-014-0822	82	VGA FOR TP9-2/4 & TP11 W CB2	L-019-1034	29
Tube Fork PLCC 84	L-014-0071	82	Vibratory Magazine VMF30	L-014-0016B	80
Tube Fork PLCC 84 Socket	L-014-0812	82	Wide board support 500T2	L-025-0241	35
Tube Fork SO-14,/16	L-014-0065D	82	VI Technology AOI Machine	K-040-0062	102
Tube Fork SO-14W	L-014-0076	82	Interface		
Tube Fork SO-20/28 (Plastic)	L-014-0064D	82	Workstation 1000 Acc Package 1	K-017-0494	57
Tube Fork SO24	L-014-0819	82	Workstation 1000 Acc Package 2	K-017-0495	57
Tube Fork SO24/33 Wide Stick	L-014-0820	82	Workstation 1000 T3	K-017-0533	51
Tube Fork SO32	L-014-0810	82	Workstation 1000 T4	K-017-0534	51
Tube Fork SO-8 (Plastic)	L-014-0062D	82	Workstation 1500 Acc Package 1	K-017-0496	57
Tube Fork SOJ 28	L-014-0821	82	Workstation 1500 Acc Package 2	K-017-0497	57
Tube Fork SOJW 32	L-014-0813	82	Workstation 1500 T3	K-017-0535	51
Tube Fork SOJW 32 Wide Stick	L-014-0814	82	Workstation 1500 T4	K-017-0536	51
Tube Fork SOL 28	L-014-0840	82	Workstation Framework 1000	K-017-0129	57
Tube Fork SOMC 14-16	L-014-0087	82	Workstation Framework 1500	K-017-0128	57
Tube Fork SOP 14	L-014-0830	82	Workstation Release Pedal	K-017-0498	55
Tube Fork SOP 14 Wide Stick	L-014-0831	82	XYFLEX PRO Adhesive Dispenser	K-040-0158	102
Tube Fork SOP 16, QSOP 16	L-014-0828	82	Interface		
Tube Fork SOP 32	L-014-0839	82	Y 345/200V 3 phase EU	0201	12
Tube Fork SOP 8	L-014-0832	82	Y 365/210V 3 phase EU	0202	12
Tube Fork SOW-8	L-014-0816	82	Y 370/215V 3 phase EU	0203	12
Tube Fork VSO 32	L-014-0823	82	Y 380/220V 3 phase EU	0204	12
Tube tool	L-009-0436	131	Y 390/225V 3 phase EU	0205	12
Turn Unit	K-017-0184	49	Y 400/230V 3 phase EU	0206	12
Twin Linescan Vision System	04111	10	Y 410/235V 3 phase EU	0207	12
TVS Slot Kit	04053	15	Y 415/240V 3 phase EU	0208	12
UMG Odd Form Placement Interface	K-040-0185	102	Y 435/250V 3 phase EU	0209	12
Universal Advanced Axial Inserter Interface	K-040-0156	102	Yestech AOI Interface	K-040-0224	102
Universal Advanced Multimod DIP Interface	K-040-0157	102	Y Wagon Table 288	L-015-0367	24
Universal GSM Interface	K-040-0052	102	Y Wagon Table 348	L-015-0368	24
Universal Instr Axial VCD INS	K-040-0050	102	Y Wagon Table 468	L-015-0369	24
Universal Instr Chipshooter	K-040-0051	102	Y Wagon Table 528	L-015-0370	24
Universal Instr Multimod (DIP)	K-040-0053	102	Y Wagon Table Upgrade	L-015-0315	24
Universal Instr Radial Ins	K-040-0054	102	Y Wagon Table Upgrade 288 for HYDRA	L-015-0375	24
Upgrade from 2PT1 to 3PT1	0505	27	Y Wagon Table Upgrade 468 for HYDRA	L-015-0376	25
Upgrade from 2PT1 to 3PT1	0505	27	Y Wagon Tray Holder	L-015-0277B	79
Upgrade from one CAD to all CAD imports	K-040-0108	101	Zevatech/Juki 500 Interface	K-040-0055	102
Upgrade Kit Board Train T5/T6	K-017-0481	55	Zevatech/Juki 700 Interface	K-040-0056	102
Upgrade Kit from GS1 to GS2	L-014-0720	110			
Upgrade kit GS2 TP12/18	L-014-0722	110			
Upgrade kit GS2 TP9/11	L-014-0721	110			
Upgrade step from SYS 2.9 (9268 & above)	03230	96			
Upgrade step from TPSys 1.3/1.4	03231	96			
Upgrade step from TPSys 1.3/1.4	0324	96			
Upgrade step from TPSys 1.5/1.6	0325	96			